

LABORATORY CONSUMABLES



- A** Robotic Tips
- B** PCR Series
- C** Universal Fit Pipette Tips
- D** Tubes
- E** Deep Well Plates

Shanghai Gene Era Bio-Science Co.,Ltd

PRODUCT CATALOG

Shanghai Gene Era Bio-Science Co., Ltd.

Global Leading Manufacturer and Supplier for Both Laboratory and Clinical Diagnostics

Since its inception, GEB has committed to manufacture and supply superior laboratory consumables to our customers.

All our products are designed by experienced engineers, and produced in the dust-free clean facility under strict manufacturing processes with premium materials. Before delivering to our customers, all products are accessed by a stringent QC process certified by ISO9001: 2015 , ISO13485: 2016 and ISO14001: 2015 to assure the high quality. We guarantee that all products are DNase/RNase, and pyrogen-free to meet the high standard of both laboratory experiment and clinical diagnostics.

Through the enduring efforts in the past few years, GEB has grown to become one of the global leading manufacturers and suppliers of consumables for laboratory and clinical diagnostics. We will continually assure our customers with better products and services.

Certifications

ISO9001:2015 • ISO13485:2016 • ISO14001:2015 • CE • SGS • FDA



The High Standard of Quality Assurance



R&R
Retentionless Recovery
Formal Low Retention Technology

Minimize sample and reagent retention
Guarantee reaction system accuracy and precision

DRM
Optimum Leakproofness
Full Range Molding Technology

Provide a better seal effect
Be more flexible to fit robotic pipetting head or manual pipettors

The High Standard of Manufacturing



100,000 Grade Clean Workshop

International Standard Molding Machine

Table of Contents

Robotic Tips

A1 - A56

Compatible with Agilent , Agilent Bravo

A2 - A4

Compatible with Beckman FX/ NX , Multimek AP96 , Biomek 3000

A5 - A13

Compatible with Biomek 4000 ,Multimek AP-96 ,CCS-head ,I-Series

A14 - A20

Compatible with Microlab Starplus, Hamilton Star, Starlet , Nimbus

Compatible with Tecan Genesis Freedom , Freedom Evo

A21 - A28

Miniprep with LiHa ,Aquarius , Te-Mo

Compatible with TecanMCA

A29 - A30

Compatible with Sciclone ,Zephyr ,RapidPlate ,PerkinElmer Janus

A31 - A38

MultiProbe, Evolution P3 ,MiniTrak ,Multiprobe II HT/ET

Compatible with Olympus

A39 - A40

Compatible with Rainin

A41

Compatible with Zymark , Zymark Rapidplate, Sciclone

A42 - A43

Compatible with Cybi -Well Vario, Cybi -WellFlex, Cybi -WellFlex Vario

A44 - A45

Cybi , CyBi -Well Family , Cybi -Well

Compatible with Dynex , DSX /DS2

A46

Compatible with HITACHI

A47

Compatible with FuJi

A47

Compatible with Biotix

A48

PCR Series

B2 - B9

Universal Fit Pipette Tips

C2 - C28

Pipette Tips Without Aerosol Barrier

C2 - C7

Pipette Tips With Aerosol Barrier

C8 - C12

Compatible with Eppendorf

C13 - C14

Compatible with Rainin

C20 - C28

Tubes

D2 - D9

Deep-Well Plates

E2 - E10

Excellent match of liquid workstations & GEB robotic tips

Robotic Tips

Accurate Liquid Handling

Genomics • Proteomics • Cellomics • Immunoassays • Metabolomics • General liquid handling



GEB DRM Dual Resin

High flexibility for better fitting, lower robotic head insertion force.



GEB TWC Thin Wall Crown

It provides you a better seal effect for robotic systems, more flexible and requires less insertion force.

ROBOTIC TIPS

Compatible with

Agilent , Agilent Bravo





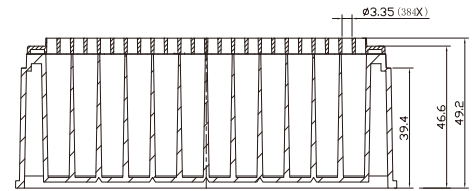
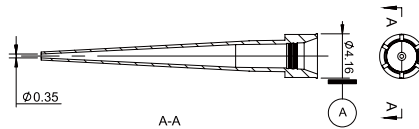
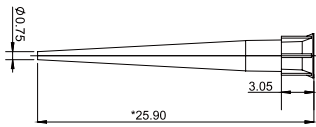
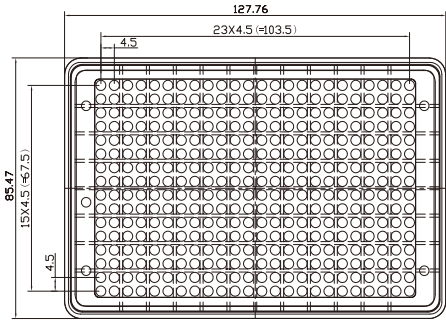

Format:384-tip format
 Tip Volume range selection:30µl
 Material: Virgin Polypropylene
 Alternatives:
 ● With/without aerosol-barrier filter
 ● Pre-Sterilized/Non-Sterilized
 ● Low Retention/Standard
 Certified:
 DNase-Free, RNase-Free, Endotoxin-Safe

Material: Polypropylene

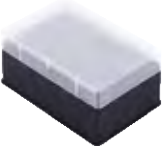

30µl

	GEB Cat#	Max Volume	Type	Packaging Specification	Carton Size L*W*H(mm)	Weight KGs
	AT030A-3-N	30µl	Natural	384 tips/rack, 10 racks/pack, 5 packs/case	500*285*405	11.2
	AT030A-3-N-LB	30µl	Natural Low Retention	384 tips/rack, 10 racks/pack, 5 packs/case	500*285*405	11.2
	AT030A-3-NS	30µl	Natural Pre-Sterilized	384 tips/rack, 10 racks/pack, 5 packs/case	500*285*405	11.2
	AT030A-3-NS-LB	30µl	Natural Low Retention Pre-Sterilized	384 tips/rack, 10 racks/pack, 5 packs/case	500*285*405	11.2
	AF030A-3-NS	30µl	Natural Filtered, Pre-Sterilized	384 tips/rack, 10 racks/pack, 5 packs/case	500*285*405	11.2
	AF030A-3-NS-LB	30µl	Natural Low Retention Filtered, Pre-Sterilized	384 tips/rack, 10 racks/pack, 5 packs/case	500*285*405	11.2

ROBOTIC TIPS

Compatible with

Agilent , Agilent Bravo





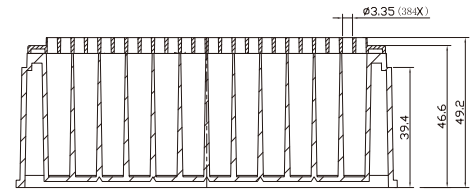
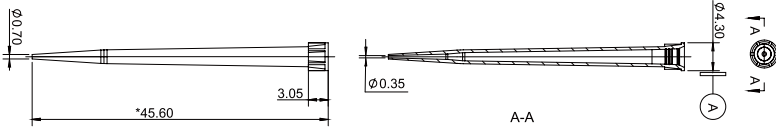
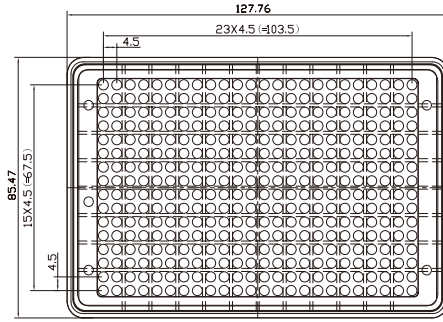

Format: 384-tip format
 Tip Volume range selection: 70µl
 Material: Virgin Polypropylene
 Alternatives:
 ● With/without aerosol-barrier filter
 ● Pre-Sterilized/Non-Sterilized
 ● Low Retention/Standard
 Certified:
 DNase-Free, RNase-Free, Endotoxin-Safe

Material: Polypropylene



70µl

GEB Cat#	Max Volume	Type	Packaging Specification	Carton Size L*W*H(mm)	Weight KGs
 AT070A-3-N	70µl	Natural	384 tips/rack, 10 racks/pack, 5 packs/case	500*285*405	17.2
 AT070A-3-N-LB	70µl	Natural Low Retention	384 tips/rack, 10 racks/pack, 5 packs/case	500*285*405	17.2
AT070A-3-NS	70µl	Natural Pre-Sterilized	384 tips/rack, 10 racks/pack, 5 packs/case	500*285*405	17.2
 AT070A-3-NS-LB	70µl	Natural Low Retention Pre-Sterilized	384 tips/rack, 10 racks/pack, 5 packs/case	500*285*405	17.2
 AF070A-3-NS	50µl	Natural Filtered, Pre-Sterilized	384 tips/rack, 10 racks/pack, 5 packs/case	500*285*405	17.2
 AF070A-3-NS-LB	50µl	Natural Low Retention Filtered, Pre-Sterilized	384 tips/rack, 10 racks/pack, 5 packs/case	500*285*405	17.2

ROBOTIC TIPS

Compatible with

Agilent , Agilent Bravo





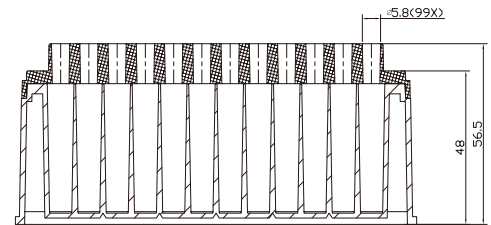
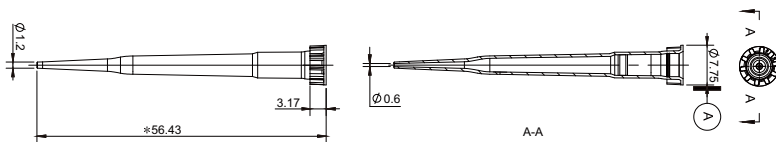
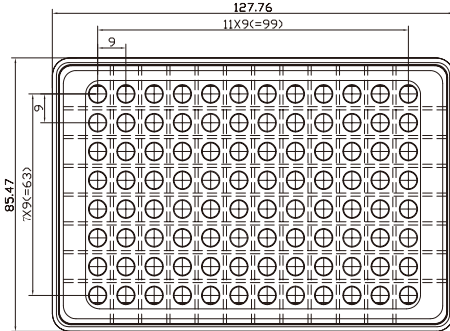

Format: 96-tip format
 Tip Volume range selection: 250µl
 Material: Virgin Polypropylene
 Alternatives:
 ● With/without aerosol-barrier filter
 ● Pre-Sterilized/Non-Sterilized
 ● Low Retention/Standard
 Certified:
 DNase-Free, RNase-Free, Endotoxin-Safe

Material: Polypropylene



250µl

GEB Cat#	Max Volume	Type	Packaging Specification	Carton Size L*W*H(mm)	Weight KGs
 AT250A-9-N	250µl	Natural	96 tips/rack, 10 racks/pack, 5 packs/case	500*285*405	13.0
 AT250A-9-N-LB	250µl	Natural Low Retention	96 tips/rack, 10 racks/pack, 5 packs/case	500*285*405	13.0
AT250A-9-NS	250µl	Natural Pre-Sterilized	96 tips/rack, 10 racks/pack, 5 packs/case	500*285*405	13.0
 AT250A-9-NS-LB	250µl	Natural Low Retention Pre-Sterilized	96 tips/rack, 10 racks/pack, 5 packs/case	500*285*405	13.0
 AF250A-9-NS	185µl	Natural Filtered, Pre-Sterilized	96 tips/rack, 10 racks/pack, 5 packs/case	500*285*405	13.0
 AF250A-9-NS-LB	185µl	Natural Low Retention Filtered, Pre-Sterilized	96 tips/rack, 10 racks/pack, 5 packs/case	500*285*405	13.0

ROBOTIC TIPS

Compatible with

Beckman FX / NX , Multimek AP96 , Biomek 3000

Biomek 4000 ,Multimek AP-96 ,Multimek CCS-head ,Multimek Type II ,I-series



Format: 96-tip format
 Tip Volume range selection: 20µl
 Material: Virgin Polypropylene
 Alternatives:
 ● With/without aerosol-barrier filter
 ● Pre-Sterilized/Non-Sterilized
 ● Low Retention/Standard
 Certified:
 DNase-Free, RNase-Free, Endotoxin-Safe

Material: Polypropylene

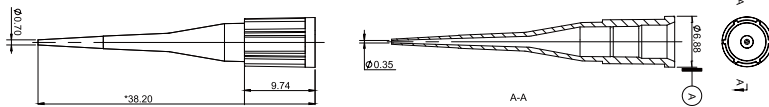
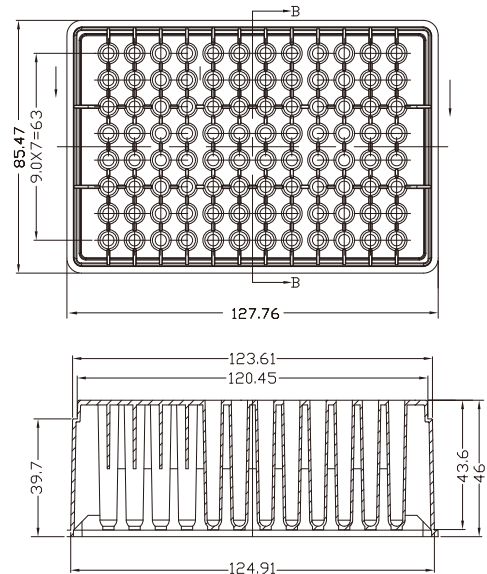

20µl

	GEB Cat#	Max Volume	Type	Packaging Specification	Carton Size L*W*H(mm)	Weight KGs
	AT020B-9-N	20µl	Natural	96 tips/rack, 10 racks/pack, 5 packs/case	480*345*280	9.8
	AT020B-9-N-LB	20µl	Natural Low Retention	96 tips/rack, 10 racks/pack, 5 packs/case	480*345*280	9.8
	AT020B-9-NS	20µl	Natural Pre-Sterilized	96 tips/rack, 10 racks/pack, 5 packs/case	480*345*280	9.8
	AT020B-9-NS-LB	20µl	Natural Low Retention Pre-Sterilized	96 tips/rack, 10 racks/pack, 5 packs/case	480*345*280	9.8
	AF020B-9-NS	20µl	Natural Filtered, Pre-Sterilized	96 tips/rack, 10 racks/pack, 5 packs/case	480*345*280	9.8
	AF020B-9-NS-LB	20µl	Natural Low Retention Filtered, Pre-Sterilized	96 tips/rack, 10 racks/pack, 5 packs/case	480*345*280	9.8
	AT020B-9B-N	20µl	Natural	96 tips/rack, 10 racks/pack, 5 packs/case	500*285*405	9.8
	AT020B-9B-N-LB	20µl	Natural Low Retention	96 tips/rack, 10 racks/pack, 5 packs/case	500*285*405	9.8
	AT020B-9B-NS	20µl	Natural Pre-Sterilized	96 tips/rack, 10 racks/pack, 5 packs/case	500*285*405	9.8
	AT020B-9B-NS-LB	20µl	Natural Low Retention Pre-Sterilized	96 tips/rack, 10 racks/pack, 5 packs/case	500*285*405	9.8
	AF020B-9B-NS	20µl	Natural Filtered, Pre-Sterilized	96 tips/rack, 10 racks/pack, 5 packs/case	500*285*405	9.8
	AF020B-9B-NS-LB	20µl	Natural Low Retention Filtered, Pre-Sterilized	96 tips/rack, 10 racks/pack, 5 packs/case	500*285*405	9.8

AT/AF020B-9

AT/AF020B-9B

ROBOTIC TIPS

Compatible with

Beckman FX / NX , Multimek AP96 , Biomek 3000

Biomek 4000 ,Multimek AP-96 ,Multimek CCS-head ,Multimek Type II ,I-series





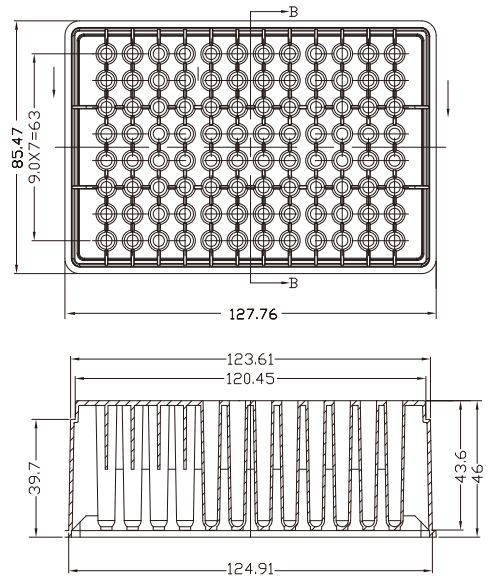

Format: 96-tip format
 Tip Volume range selection: 20µl
 Material: Conductive Polypropylene
 Alternatives:
 ● With/without aerosol-barrier filter
 ● Pre-Sterilized/Non-Sterilized
 ● Low Retention/Standard
 Certified:
 DNase-Free, RNase-Free, Endotoxin-Safe

Material: Polypropylene

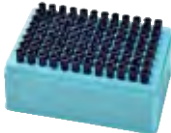
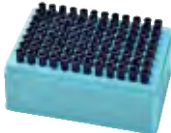
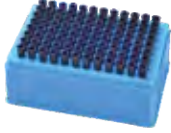
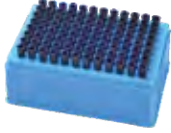

20µl

GEB Cat#	Max Volume	Type	Packaging Specification	Carton Size L*W*H(mm)	Weight KGs
 AT020B-9-X	20µl	Black	96 tips/rack, 10 racks/pack, 5 packs/case	480*345*280	9.8
 AT020B-9-X-LB	20µl	Black Low Retention	96 tips/rack, 10 racks/pack, 5 packs/case	480*345*280	9.8
AT020B-9-XS	20µl	Black Pre-Sterilized	96 tips/rack, 10 racks/pack, 5 packs/case	480*345*280	9.8
 AT020B-9-XS-LB	20µl	Black Low Retention Pre-Sterilized	96 tips/rack, 10 racks/pack, 5 packs/case	480*345*280	9.8
AF020B-9-XS	20µl	Black Filtered, Pre-Sterilized	96 tips/rack, 10 racks/pack, 5 packs/case	480*345*280	9.8
 AF020B-9-XS-LB	20µl	Black Low Retention Filtered, Pre-Sterilized	96 tips/rack, 10 racks/pack, 5 packs/case	480*345*280	9.8
 AT020B-9B-X	20µl	Black	96 tips/rack, 10 racks/pack, 5 packs/case	500*285*405	9.8
 AT020B-9B-X-LB	20µl	Black Low Retention	96 tips/rack, 10 racks/pack, 5 packs/case	500*285*405	9.8
AT020B-9B-XS	20µl	Black Pre-Sterilized	96 tips/rack, 10 racks/pack, 5 packs/case	500*285*405	9.8
 AT020B-9B-XS-LB	20µl	Black Low Retention Pre-Sterilized	96 tips/rack, 10 racks/pack, 5 packs/case	500*285*405	9.8
AT/AF020B-9B	20µl	Black Filtered, Pre-Sterilized	96 tips/rack, 10 racks/pack, 5 packs/case	500*285*405	9.8
 AT/AF020B-9B	20µl	Black Low Retention Filtered, Pre-Sterilized	96 tips/rack, 10 racks/pack, 5 packs/case	500*285*405	9.8

ROBOTIC TIPS

Compatible with

Beckman FX / NX , Multimek AP96 , Biomek 3000

Biomek 4000 ,Multimek AP-96 ,Multimek CCS-head ,Multimek Type II ,I-series



Format: 96-tip format
 Tip Volume range selection: 50µl
 Material: Virgin Polypropylene
 Alternatives:
 ● With/without aerosol-barrier filter
 ● Pre-Sterilized/Non-Sterilized
 ● Low Retention/Standard
 Certified:
 DNase-Free, RNase-Free, Endotoxin-Safe

Material: Polypropylene

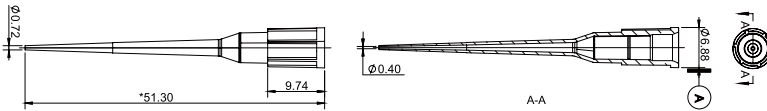
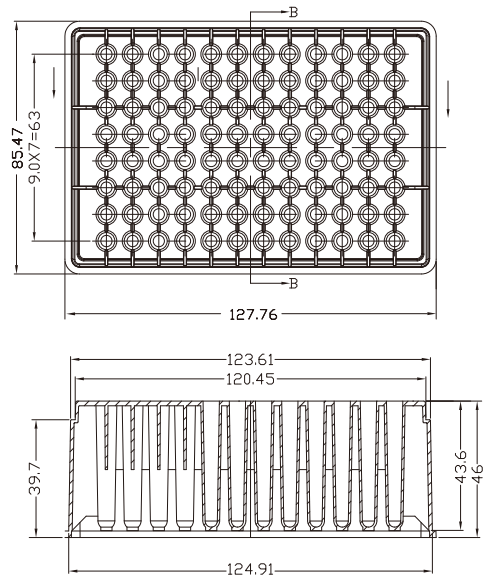

50µl

	GEB Cat#	Max Volume	Type	Packaging Specification	Carton Size L*W*H(mm)	Weight KGs
	AT050B-9-N	50µl	Natural	96 tips/rack, 10 racks/pack, 5 packs/case	480*345*280	10.1
	AT050B-9-N-LB	50µl	Natural Low Retention	96 tips/rack, 10 racks/pack, 5 packs/case	480*345*280	10.1
	AT050B-9-NS	50µl	Natural Pre-Sterilized	96 tips/rack, 10 racks/pack, 5 packs/case	480*345*280	10.1
	AT050B-9-NS-LB	50µl	Natural Low Retention Pre-Sterilized	96 tips/rack, 10 racks/pack, 5 packs/case	480*345*280	10.1
	AF050B-9-NS	50µl	Natural Filtered, Pre-Sterilized	96 tips/rack, 10 racks/pack, 5 packs/case	480*345*280	10.1
	AF050B-9-NS-LB	50µl	Natural Low Retention Filtered, Pre-Sterilized	96 tips/rack, 10 racks/pack, 5 packs/case	480*345*280	10.1
AT/AF050B-9	AT050B-9B-N	50µl	Natural	96 tips/rack, 10 racks/pack, 5 packs/case	500*285*405	10.2
	AT050B-9B-N-LB	50µl	Natural Low Retention	96 tips/rack, 10 racks/pack, 5 packs/case	500*285*405	10.2
	AT050B-9B-NS	50µl	Natural Pre-Sterilized	96 tips/rack, 10 racks/pack, 5 packs/case	500*285*405	10.2
	AT050B-9B-NS-LB	50µl	Natural Low Retention Pre-Sterilized	96 tips/rack, 10 racks/pack, 5 packs/case	500*285*405	10.2
AT/AF050B-9B	AF050B-9B-NS	50µl	Natural Filtered, Pre-Sterilized	96 tips/rack, 10 racks/pack, 5 packs/case	500*285*405	10.2
	AF050B-9B-NS-LB	50µl	Natural Low Retention Filtered, Pre-Sterilized	96 tips/rack, 10 racks/pack, 5 packs/case	500*285*405	10.2

ROBOTIC TIPS

Compatible with

Beckman FX / NX , Multimek AP96 , Biomek 3000

Biomek 4000 ,Multimek AP-96 ,Multimek CCS-head ,Multimek Type II ,I-series



Format: 96-tip format
 Tip Volume range selection: 50µl
 Material: Conductive Polypropylene
 Alternatives:
 ● With/without aerosol-barrier filter
 ● Pre-Sterilized/Non-Sterilized
 ● Low Retention/Standard
 Certified:
 DNase-Free, RNase-Free, Endotoxin-Safe

Material: Polypropylene

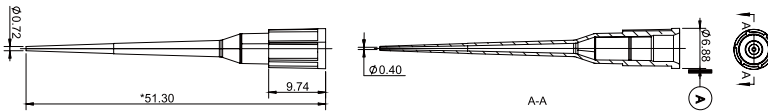
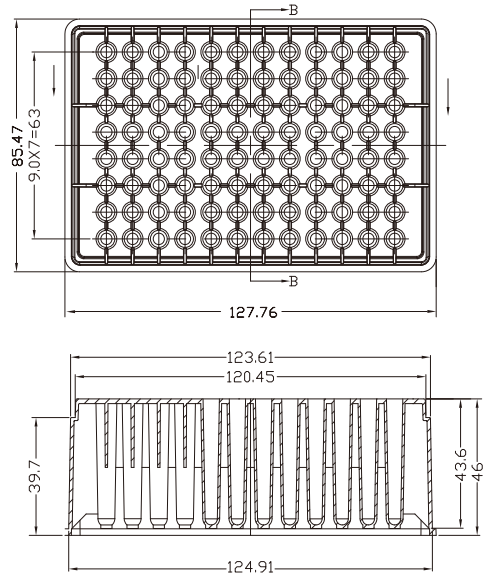

50µl

	GEB Cat#	Max Volume	Type	Packaging Specification	Carton Size L*W*H(mm)	Weight KGs
	AT050B-9-X	50µl	Black	96 tips/rack, 10 racks/pack, 5 packs/case	480*345*280	10.1
	AT050B-9-X-LB	50µl	Black Low Retention	96 tips/rack, 10 racks/pack, 5 packs/case	480*345*280	10.1
	AT050B-9-XS	50µl	Black Pre-Sterilized	96 tips/rack, 10 racks/pack, 5 packs/case	480*345*280	10.1
	AT050B-9-XS-LB	50µl	Black Low Retention Pre-Sterilized	96 tips/rack, 10 racks/pack, 5 packs/case	480*345*280	10.1
	AF050B-9-XS	50µl	Black Filtered, Pre-Sterilized	96 tips/rack, 10 racks/pack, 5 packs/case	480*345*280	10.1
	AF050B-9-XS-LB	50µl	Black Low Retention Filtered, Pre-Sterilized	96 tips/rack, 10 racks/pack, 5 packs/case	480*345*280	10.1
	AT050B-9B-X	50µl	Black	96 tips/rack, 10 racks/pack, 5 packs/case	500*285*405	10.2
	AT050B-9B-X-LB	50µl	Black Low Retention	96 tips/rack, 10 racks/pack, 5 packs/case	500*285*405	10.2
AT/AF050B-9	AT050B-9B-XS	50µl	Black Pre-Sterilized	96 tips/rack, 10 racks/pack, 5 packs/case	500*285*405	10.2
	AT050B-9B-XS-LB	50µl	Black Low Retention Pre-Sterilized	96 tips/rack, 10 racks/pack, 5 packs/case	500*285*405	10.2
	AF050B-9B-XS	50µl	Black Filtered, Pre-Sterilized	96 tips/rack, 10 racks/pack, 5 packs/case	500*285*405	10.2
AT/AF050B-9B	AF050B-9B-XS-LB	50µl	Black Low Retention Filtered, Pre-Sterilized	96 tips/rack, 10 racks/pack, 5 packs/case	500*285*405	10.2

ROBOTIC TIPS

Compatible with

Beckman FX / NX , Multimek AP96 , Biomek 3000

Biomek 4000 ,Multimek AP-96 ,Multimek CCS-head ,Multimek Type II ,I-series



Material: Polypropylene



Format: 96-tip format
 Tip Volume range selection: 250µl
 Material: Virgin Polypropylene
 Alternatives:
 ○ With/without aerosol-barrier filter
 ○ Pre-Sterilized/Non-Sterilized
 ○ Low Retention/Standard
 Certified:
 DNase-Free, RNase-Free, Endotoxin-Safe

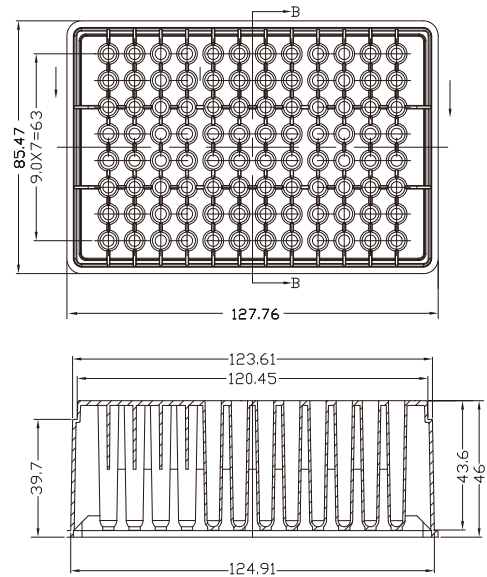
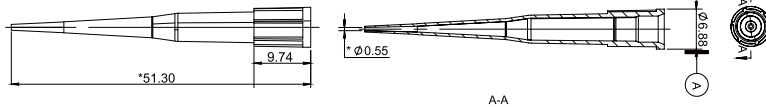

250µl

	GEB Cat#	Max Volume	Type	Packaging Specification	Carton Size L*W*H(mm)	Weight KGs
	AT250B-9-N	250µl	Natural	96 tips/rack, 10 racks/pack, 5 packs/case	480*345*280	10.4
	AT250B-9-N-LB	250µl	Natural Low Retention	96 tips/rack, 10 racks/pack, 5 packs/case	480*345*280	10.4
	AT250B-9-NS	250µl	Natural Pre-Sterilized	96 tips/rack, 10 racks/pack, 5 packs/case	480*345*280	10.4
	AT250B-9-NS-LB	250µl	Natural Low Retention Pre-Sterilized	96 tips/rack, 10 racks/pack, 5 packs/case	480*345*280	10.4
	AF250B-9-NS	180µl	Natural Filtered, Pre-Sterilized	96 tips/rack, 10 racks/pack, 5 packs/case	480*345*280	10.4
	AF250B-9-NS-LB	180µl	Natural Low Retention Filtered, Pre-Sterilized	96 tips/rack, 10 racks/pack, 5 packs/case	480*345*280	10.4
	AT250B-9B-N	250µl	Natural	96 tips/rack, 10 racks/pack, 5 packs/case	500*285*405	10.2
	AT250B-9B-N-LB	250µl	Natural Low Retention	96 tips/rack, 10 racks/pack, 5 packs/case	500*285*405	10.2
	AT250B-9B-NS	250µl	Natural Pre-Sterilized	96 tips/rack, 10 racks/pack, 5 packs/case	500*285*405	10.2
	AT250B-9B-NS-LB	250µl	Natural Low Retention Pre-Sterilized	96 tips/rack, 10 racks/pack, 5 packs/case	500*285*405	10.2
	AF250B-9B-NS	180µl	Natural Filtered, Pre-Sterilized	96 tips/rack, 10 racks/pack, 5 packs/case	500*285*405	10.2
	AF250B-9B-NS-LB	180µl	Natural Low Retention Filtered, Pre-Sterilized	96 tips/rack, 10 racks/pack, 5 packs/case	500*285*405	10.2

ROBOTIC TIPS

Compatible with

Beckman FX / NX , Multimek AP96 , Biomek 3000

Biomek 4000 ,Multimek AP-96 ,Multimek CCS-head ,Multimek Type II ,I-series







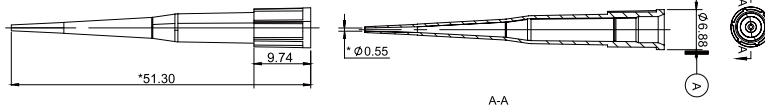
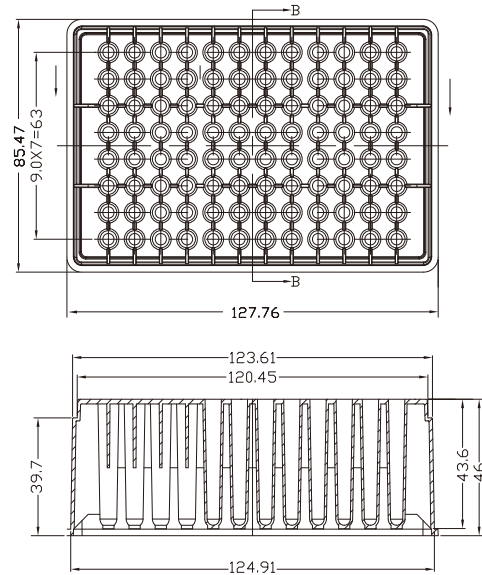

Format: 96-tip format
 Tip Volume range selection: 250µl
 Material: Conductive Polypropylene
 Alternatives:
 ● With/without aerosol-barrier filter
 ● Pre-Sterilized/Non-Sterilized
 ● Low Retention/Standard
 Certified:
 DNase-Free, RNase-Free, Endotoxin-Safe

Material: Polypropylene



250µl

GEB Cat#	Max Volume	Type	Packaging Specification	Carton Size L*W*H(mm)	Weight KGs
AT250B-9-X	250µl	Black	96 tips/rack, 10 racks/pack, 5 packs/case	480*345*280	10.4
 AT250B-9-X-LB	250µl	Black Low Retention	96 tips/rack, 10 racks/pack, 5 packs/case	480*345*280	10.4
AT250B-9-XS	250µl	Black Pre-Sterilized	96 tips/rack, 10 racks/pack, 5 packs/case	480*345*280	10.4
 AT250B-9-XS-LB	250µl	Black Low Retention Pre-Sterilized	96 tips/rack, 10 racks/pack, 5 packs/case	480*345*280	10.4
AF250B-9-XS	180µl	Black Filtered, Pre-Sterilized	96 tips/rack, 10 racks/pack, 5 packs/case	480*345*280	10.4
 AF250B-9-XS-LB	180µl	Black Low Retention Filtered, Pre-Sterilized	96 tips/rack, 10 racks/pack, 5 packs/case	480*345*280	10.4
AT250B-9B-X	250µl	Black	96 tips/rack, 10 racks/pack, 5 packs/case	480*345*280	10.2
 AT250B-9B-X-LB	250µl	Black Low Retention	96 tips/rack, 10 racks/pack, 5 packs/case	480*345*280	10.2
AT250B-9B-XS	250µl	Black Pre-Sterilized	96 tips/rack, 10 racks/pack, 5 packs/case	480*345*280	10.2
 AT250B-9B-XS-LB	250µl	Black Low Retention Pre-Sterilized	96 tips/rack, 10 racks/pack, 5 packs/case	480*345*280	10.2
AF250B-9B-XS	180µl	Black Filtered, Pre-Sterilized	96 tips/rack, 10 racks/pack, 5 packs/case	480*345*280	10.2
 AF250B-9B-XS-LB	180µl	Black Low Retention Filtered, Pre-Sterilized	96 tips/rack, 10 racks/pack, 5 packs/case	480*345*280	10.2



AT/AF250B-9



AT/AF250B-9B

ROBOTIC TIPS

Compatible with

Beckman FX / NX , Multimek AP96 , Biomek 3000

Biomek 4000 ,Multimek AP-96 ,Multimek CCS-head ,Multimek Type II ,I-series



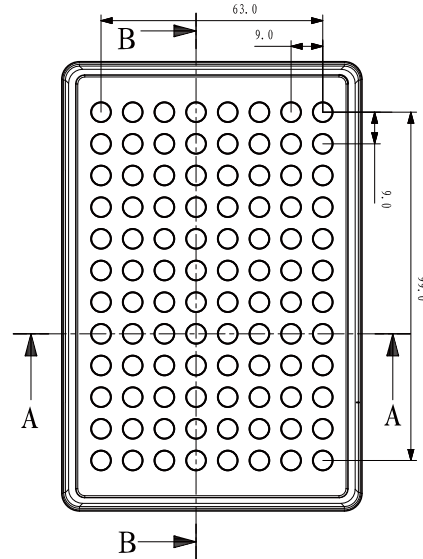
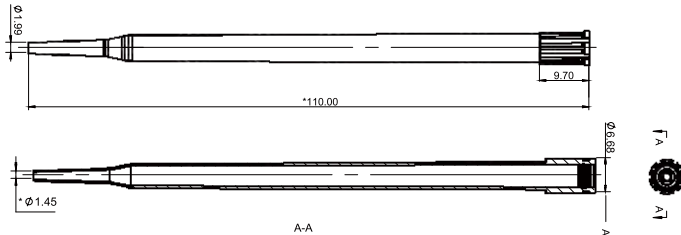

Format: 96-tip format
 Tip Volume range selection: 1000µl
 Material: Virgin Polypropylene
 Alternatives:
 ○ With/without aerosol-barrier filter
 ○ Pre-Sterilized/Non-Sterilized
 ○ Low Retention/Standard
 Certified:
 DNase-Free, RNase-Free, Endotoxin-Safe

Material: Polypropylene



1000µl

GEB Cat#	Max Volume	Type	Packaging Specification	Carton Size L*W*H(mm)	Weight KGs
AT01MB-9-N	1000µl	Natural	96 tips/rack, 20 racks/case	455*265*255	8.9
 AT01MB-9-N-LB	1000µl	Natural Low Retention	96 tips/rack, 20 racks/case	455*265*255	8.9
AT01MB-9-NS	1000µl	Natural Pre-Sterilized	96 tips/rack, 20 racks/case	455*265*255	8.9
 AT01MB-9-NS-LB	1000µl	Natural Low Retention, Pre-Sterilized	96 tips/rack, 20 racks/case	455*265*255	8.9
AF01MB-9-NS	1000µl	Natural Filtered, Pre-Sterilized	96 tips/rack, 20 racks/case	455*265*255	8.9
 AF01MB-9-NS-LB	1000µl	Natural, Filtered Pre-Sterilized, Low Retention	96 tips/rack, 20 racks/case	455*265*255	8.9



ROBOTIC TIPS

Compatible with

Beckman FX / NX , Multimek AP96 , Biomek 3000

Biomek 4000 ,Multimek AP-96 ,Multimek CCS-head ,Multimek Type II ,I-series



Material: Polypropylene



Format: 96-tip format
 Tip Volume range selection: 1000µl
 Material: Conductive Polypropylene
 Alternatives:
 ● With/without aerosol-barrier filter
 ● Pre-Sterilized/Non-Sterilized
 ● Low Retention/Standard
 Certified:
 DNase-Free, RNase-Free, Endotoxin-Safe

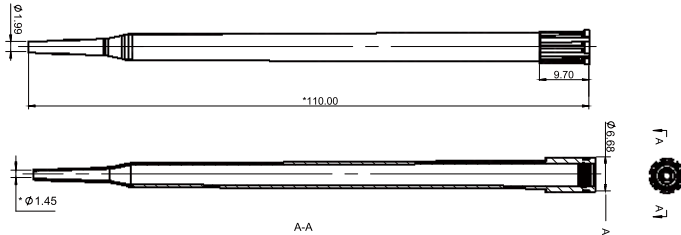
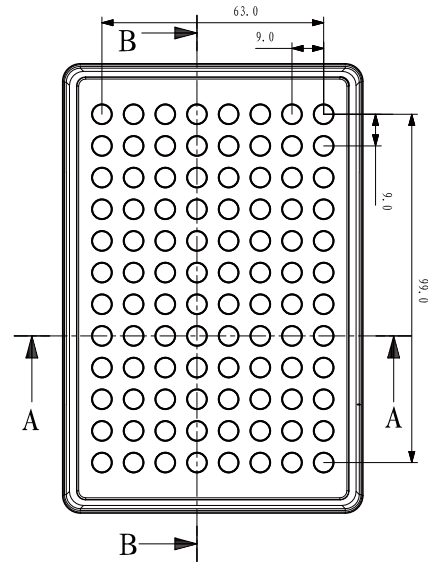

1000µl

GEB Cat#	Max Volume	Type	Packaging Specification	Carton Size L*W*H(mm)	Weight KGs
AT01MB-9-X	1000µl	Black	96 tips/rack, 20 racks per case	455*265*255	8.9
 AT01MB-9-X-LB	1000µl	Black Low Retention	96 tips/rack, 20 racks per case	455*265*255	8.9
AT01MB-9-XS	1000µl	Black Pre-Sterilized	96 tips/rack, 20 racks per case	455*265*255	8.9
 AT01MB-9-XS-LB	1000µl	Black Low Retention, Pre-Sterilized	96 tips/rack, 20 racks per case	455*265*255	8.9
AF01MB-9-XS	1000µl	Black Filtered, Pre-Sterilized	96 tips/rack, 20 racks per case	455*265*255	8.9
 AF01MB-9-XS-LB	1000µl	Black , Filtered Pre-Sterilized , Low Retention	96 tips/rack, 20 racks per case	455*265*255	8.9



ROBOTIC TIPS

Compatible with

Beckman FX / NX , Multimek AP96 , Biomek 3000

Biomek 4000 ,Multimek AP-96 ,Multimek CCS-head ,Multimek Type II ,I-series

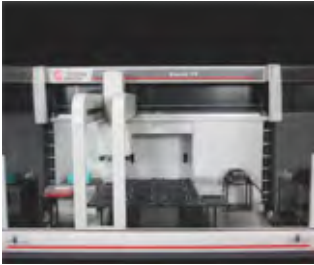

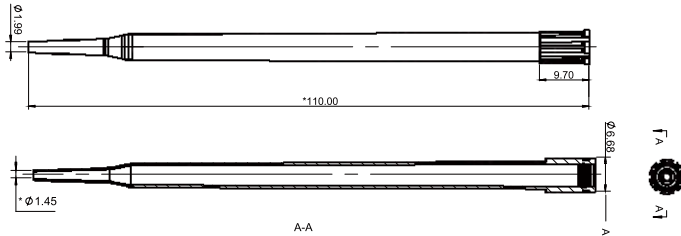
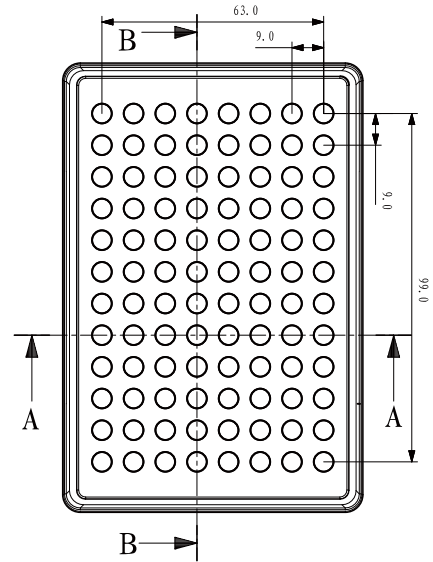

Format: 96-tip format
 Tip Volume range selection: 1000µl
 Material: Virgin Polypropylene
 Alternatives:
 ● With/without aerosol-barrier filter
 ● Pre-Sterilized/Non-Sterilized
 ● Low Retention/Standard
 Certified:
 DNase-Free, RNase-Free, Endotoxin-Safe

Material: Polypropylene



1000µl

GEB Cat#	Max Volume	Type	Packaging Specification
ATO1MB-9-TS	1000µl	Natural, Soft	96 tips/rack, 5 racks/case
 ATO1MB-9-TS-LB	1000µl	Natural, Soft Low Retention	96 tips/rack, 5 racks/case
ATO1MB-9-TS-NS	1000µl	Natural, Soft	96 tips/rack, 5 racks/case
 ATO1MB-9-TS-NS-LB	1000µl	Natural, Soft, Low Retention	96 tips/rack, 5 racks/case
AFO1MB-9-TS-NS	1000µl	Natural, Soft, Low Retention, Pre-Sterilized	96 tips/rack, 5 racks/case
 AFO1MB-9-TS-NS-LB	1000µl	Natural, Soft, Low Retention, Filtered Pre-Sterilized	96 tips/rack, 5 racks/case



ROBOTIC TIPS

Compatible with

Hamilton Star , Starlet and Nimbus , Microlab Starplus



Format: 96-tip format
 Tip Volume range selection: 50µl
 Material: Virgin Polypropylene
 Alternatives:
 ○ With/without aerosol-barrier filter
 ○ Pre-Sterilized/Non-Sterilized
 ○ Low Retention/Standard
 Certified:
 DNase-Free, RNase-Free, Endotoxin-Safe

Material: Polypropylene

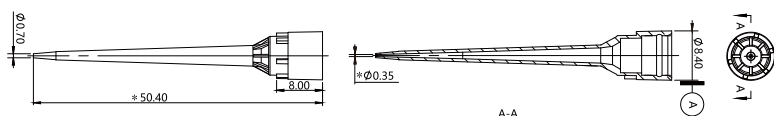
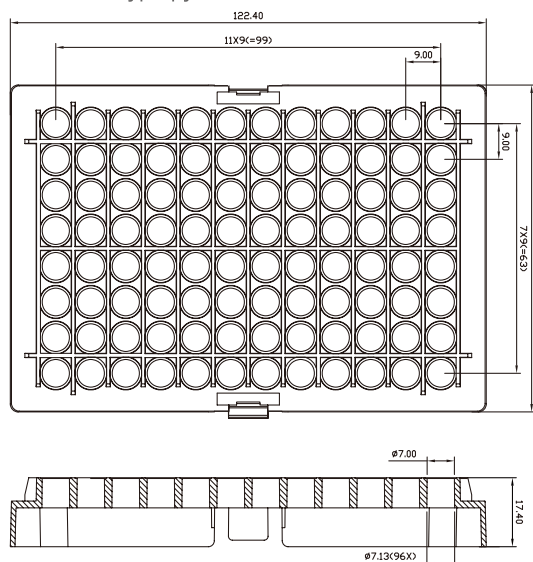

50µl

GEB Cat#	Max Volume	Type	Packaging Specification	Carton Size L*W*H(mm)	Weight KGS
AT050H-H-N	50µl	Natural	96 tips/rack, 24 racks/case	405*285*235	4.0
 AT050H-H-N-LB	50µl	Natural Low Retention	96 tips/rack, 24 racks/case	405*285*235	4.0
AT050H-H-NS	50µl	Natural Pre-Sterilized	96 tips/rack, 24 racks/case	405*285*235	4.0
 AT050H-H-NS-LB	50µl	Natural Low Retention, Pre-Sterilized	96 tips/rack, 24 racks/case	405*285*235	4.0
AF050H-H-NS	50µl	Natural Filtered, Pre-Sterilized	96 tips/rack, 24 racks/case	405*285*235	4.0
 AF050H-H-NS-LB	50µl	Natural, Low Retention Filtered, Pre-Sterilized	96 tips/rack, 24 racks/case	405*285*235	4.0
AT050H-H2-N	50µl	Natural	2x96 tips/rack 5 racks / pack , 10 packs/case	465*295*455	11.6
 AT050H-H2-N-LB	50µl	Natural Low Retention	2x96 tips/rack 5 racks / pack , 10 packs/case	465*295*455	11.6
AF050H-H2-NS	50µl	Natural Filtered, Pre-Sterilized	2x96 tips/rack 5 racks / pack , 10 packs/case	465*295*455	11.6
 AF050H-H2-NS-LB	50µl	Natural, Low Retention Filtered, Pre-Sterilized	2x96 tips/rack 5 racks / pack , 10 packs/case	465*295*455	11.6
AT050H-9N-N	50µl	Natural	96 tips / rack 4 racks / stack, 30stacks / case	500*285*405	7.6
 AT050H-9N-N-LB	50µl	Natural Low Retention	96 tips / rack 4 racks / stack, 30stacks / case	500*285*405	7.6
AT050H-H5-N	50µl	Natural	96tips / rack 5racks /stack,12stacks/case	505*355*455	6.8
 AT050H-H5-N-LB	50µl	Natural Low Retention	96tips / rack 5racks /stack,12stacks/case	505*355*455	6.8
AT050H-H5-NS	50µl	Natural Pre-Sterilized	96tips / rack 5racks /stack,12stacks/case	505*355*455	6.8
 AT050H-H5-NS-LB	50µl	Natural Low Retention, Pre-Sterilized	96tips / rack 5racks /stack,12stacks/case	505*355*455	6.8
AF050H-H5-NS	50µl	Natural Filtered, Pre-Sterilized	96tips / rack 5racks /stack,12stacks/case	505*355*455	6.8
 AF050H-H5-NS-LB	50µl	Natural, Low Retention Filtered, Pre-Sterilized	96tips / rack 5racks /stack,12stacks/case	505*355*455	6.8

ROBOTIC TIPS

Compatible with

Hamilton Star , Starlet and Nimbus, Microlab Starplus



Format: 96-tip format
 Tip Volume range selection: 50µl
 Material: Conductive Polypropylene
 Alternatives:
 ● With/without aerosol-barrier filter
 ● Pre-Sterilized/Non-Sterilized
 ● Low Retention/Standard
 Certified:
 DNase-Free, RNase-Free, Endotoxin-Safe

Material: Polypropylene

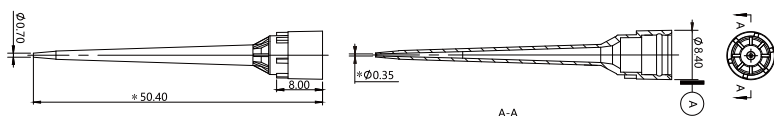
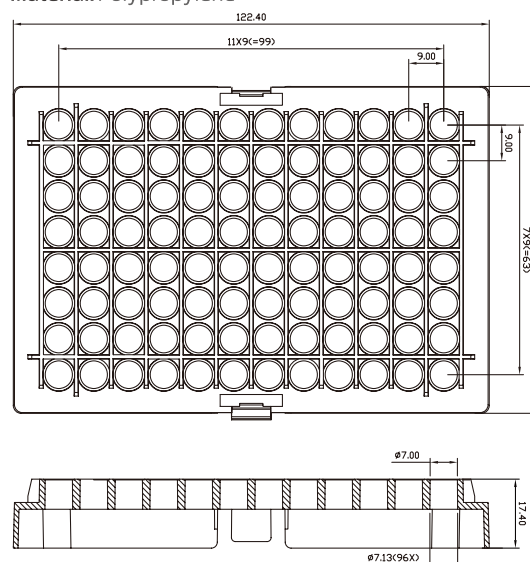

50µl

	GEB Cat#	Max Volume	Type	Packaging Specification	Carton Size L*W*H(mm)	Weight KGs
	AT050H-H-X	50µl	Black	96 tips/rack, 24 racks/case	405*285*235	4.0
	AT050H-H-X-LB	50µl	Black Low Retention	96 tips/rack, 24 racks/case	405*285*235	4.0
	AT050H-H-XS	50µl	Black Pre-Sterilized	96 tips/rack, 24 racks/case	405*285*235	4.0
	AT050H-H-XS-LB	50µl	Black Low Retention, Pre-Sterilized	96 tips/rack, 24 racks/case	405*285*235	4.0
	AF050H-H-XS	50µl	Black Filtered, Pre-Sterilized	96 tips/rack, 24 racks/case	405*285*235	4.0
	AF050H-H-XS-LB	50µl	Black, Low Retention Filtered, Pre-Sterilized	96 tips/rack, 24 racks/case	405*285*235	4.0
	AT050H-H2-X	50µl	Black	2x96 tips/rack 5 racks / pack , 10 packs/case	465*295*455	11.6
	AT050H-H2-X-LB	50µl	Black Low Retention	2x96 tips/rack 5 racks / pack , 10 packs/case	465*295*455	11.6
	AF050H-H2-XS	50µl	Black Filtered, Pre-Sterilized	2x96 tips/rack 5 racks / pack , 10 packs/case	465*295*455	11.6
	AF050H-H2-XS-LB	50µl	Black , Low Retention Filtered, Pre-Sterilized	2x96 tips/rack 5 racks / pack , 10 packs/case	465*295*455	11.6
	AT050H-9N-X	50µl	Black	96 tips / rack 4 racks / stack, 30stacks / case	500*285*405	7.6
	AT050H-9N-X-LB	50µl	Black Low Retention	96 tips / rack 4 racks / stack, 30stacks / case	500*285*405	7.6
	AT050H-H5-X	50µl	Black	96tips / rack 5racks /stack, 12stacks/case	505*355*455	6.8
	AT050H-H5-X-LB	50µl	Black Low Retention	96tips / rack 5racks /stack, 12stacks/case	505*355*455	6.8
	AT050H-H5-XS	50µl	Black Pre-Sterilized	96tips / rack 5racks /stack, 12stacks/case	505*355*455	6.8
	AT050H-H5-XS-LB	50µl	Black Low Retention, Pre-Sterilized	96tips / rack 5racks /stack, 12stacks/case	505*355*455	6.8
	AF050H-H5-XS	50µl	Black Filtered, Pre-Sterilized	96tips / rack 5racks /stack, 12stacks/case	505*355*455	6.8
	AF050H-H5-XS-LB	50µl	Black, Low Retention Filtered, Pre-Sterilized	96tips / rack 5racks /stack, 12stacks/case	505*355*455	6.8

ROBOTIC TIPS

Compatible with

Hamilton Star , Starlet and Nimbus , Microlab Starplus



Format: 96-tip format
 Tip Volume range selection: 300µl
 Material: Virgin Polypropylene
 Alternatives:
 ● With/without aerosol-barrier filter
 ● Pre-Sterilized/Non-Sterilized
 ● Low Retention/Standard
 Certified:
 DNase-Free, RNase-Free, Endotoxin-Safe

Material: Polypropylene

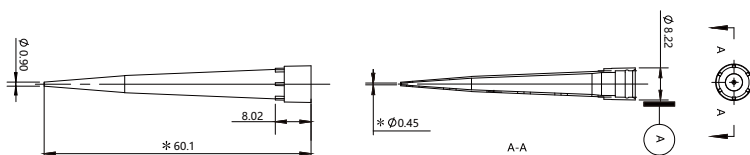
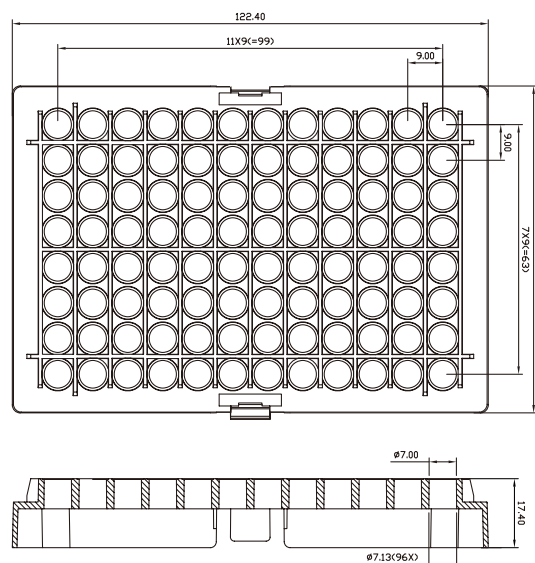

300µl

	GEB Cat#	Max Volume	Type	Packaging Specification	Carton Size L*W*H(mm)	Weight KGs
	AT300H-H-N	300µl	Natural	96 tips/rack, 24 racks/case	405*285*235	4.0
	AT300H-H-N-LB	300µl	Natural Low Retention	96 tips/rack, 24 racks/case	405*285*235	4.0
	AT300H-H-NS	300µl	Natural Pre-Sterilized	96 tips/rack, 24 racks/case	405*285*235	4.0
	AT300H-H-NS-LB	300µl	Natural Low Retention, Pre-Sterilized	96 tips/rack, 24 racks/case	405*285*235	4.0
	AF300H-H-NS	300µl	Natural Filtered, Pre-Sterilized	96 tips/rack, 24 racks/case	405*285*235	4.0
	AF300H-H-NS-LB	300µl	Natural, Low Retention Filtered, Pre-Sterilized	96 tips/rack, 24 racks/case	405*285*235	4.0
	AT300H-H2-N	300µl	Natural	2x96 tips/rack 5 racks / pack , 10 packs/case	465*295*455	11.6
	AT300H-H2-N-LB	300µl	Natural Low Retention	2x96 tips/rack 5 racks / pack , 10 packs/case	465*295*455	11.6
	AF300H-H2-NS	300µl	Natural Filtered, Pre-Sterilized	2x96 tips/rack 5 racks / pack , 10 packs/case	465*295*455	11.6
	AF300H-H2-NS-LB	300µl	Natural, Low Retention Filtered, Pre-Sterilized	2x96 tips/rack 5 racks / pack , 10 packs/case	465*295*455	11.6
	AT300H-9N-N	300µl	Natural	96 tips / rack 4 racks / stack, 30stacks / case	500*285*405	7.6
	AT300H-9N-N-LB	300µl	Natural Low Retention	96 tips / rack 4 racks / stack, 30stacks / case	500*285*405	7.6
	AT300H-H5-N	300µl	Natural	96tips /rack 5racks /stack,12stacks/case	505*355*455	7.5
	AT300H-H5-N-LB	300µl	Natural Low Retention	96tips /rack 5racks /stack,12stacks/case	505*355*455	7.5
	AT300H-H5-NS	300µl	Natural Pre-Sterilized	96tips /rack 5racks /stack,12stacks/case	505*355*455	7.5
	AT300H-H5-NS-LB	300µl	Natural Low Retention, Pre-Sterilized	96tips /rack 5racks /stack,12stacks/case	505*355*455	7.5
	AF300H-H5-NS	300µl	Natural Filtered, Pre-Sterilized	96tips /rack 5racks /stack,12stacks/case	505*355*455	7.5
	AF300H-H5-NS-LB	300µl	Natural, Low Retention Filtered, Pre-Sterilized	96tips /rack 5racks /stack,12stacks/case	505*355*455	7.5

ROBOTIC TIPS

Compatible with

Hamilton Star , Starlet and Nimbus, Microlab Starplus



Format: 96-tip format
 Tip Volume range selection: 300µl
 Material: Conductive Polypropylene
 Alternatives:
 ● With/without aerosol-barrier filter
 ● Pre-Sterilized/Non-Sterilized
 ● Low Retention/Standard
 Certified:
 DNase-Free, RNase-Free, Endotoxin-Safe

Material: Polypropylene

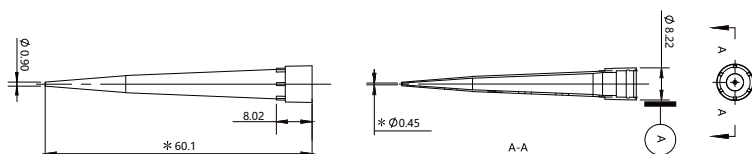
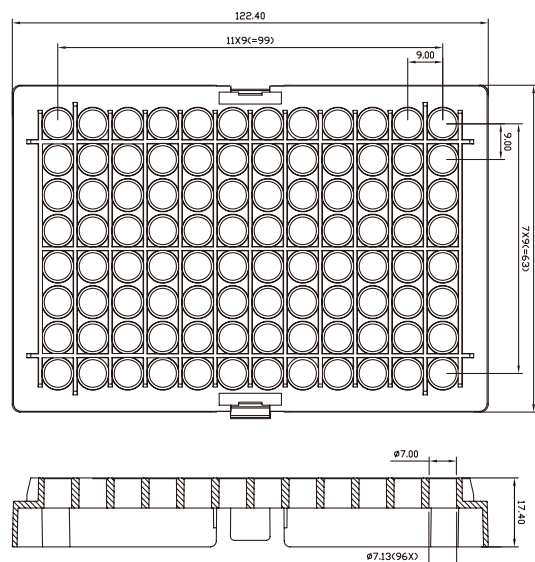

300µl

	GEB Cat#	Max Volume	Type	Packaging Specification	Carton Size L*W*H(mm)	Weight KGs
	AT300H-H-X	300µl	Black	96 tips/rack, 24 racks/case	405*285*235	4.0
	AT300H-H-X-LB	300µl	Black Low Retention	96 tips/rack, 24 racks/case	405*285*235	4.0
	AT300H-H-XS	300µl	Black Pre-Sterilized	96 tips/rack, 24 racks/case	405*285*235	4.0
	AT300H-H-XS-LB	300µl	Black Low Retention, Pre-Sterilized	96 tips/rack, 24 racks/case	405*285*235	4.0
	AF300H-H-XS	300µl	Black Filtered, Pre-Sterilized	96 tips/rack, 24 racks/case	405*285*235	4.0
	AF300H-H-XS-LB	300µl	Black, Low Retention Filtered, Pre-Sterilized	96 tips/rack, 24 racks/case	405*285*235	4.0
	AT300H-H2-X	300µl	Black	2x96 tips/rack 5 racks / pack , 10 packs/case	465*295*455	11.6
	AT300H-H2-X-LB	300µl	Black Low Retention	2x96 tips/rack 5 racks / pack , 10 packs/case	465*295*455	11.6
	AF300H-H2-XS	300µl	Black Filtered, Pre-Sterilized	2x96 tips/rack 5 racks / pack , 10 packs/case	465*295*455	11.6
	AF300H-H2-XS-LB	300µl	Black, Low Retention Filtered, Pre-Sterilized	2x96 tips/rack 5 racks / pack , 10 packs/case	465*295*455	11.6
	AT300H-9N-X	300µl	Black	96 tips / rack 4 racks / stack, 30stacks / case	500*285*405	7.6
	AT300H-9N-X-LB	300µl	Black Low Retention	96 tips / rack 4 racks / stack, 30stacks / case	500*285*405	7.6
	AT300H-H5-X	300µl	Black	96tips / rack 5racks / stack, 12stacks/case	505*355*455	7.5
	AT300H-H5-X-LB	300µl	Black Low Retention	96tips / rack 5racks / stack, 12stacks/case	505*355*455	7.5
	AT300H-H5-XS	300µl	Black Pre-Sterilized	96tips / rack 5racks / stack, 12stacks/case	505*355*455	7.5
	AT300H-H5-XS-LB	300µl	Black Low Retention, Pre-Sterilized	96tips / rack 5racks / stack, 12stacks/case	505*355*455	7.5
	AF300H-H5-XS	300µl	Black Filtered, Pre-Sterilized	96tips / rack 5racks / stack, 12stacks/case	505*355*455	7.5
	AF300H-H5-XS-LB	300µl	Black, Low Retention Filtered, Pre-Sterilized	96tips / rack 5racks / stack, 12stacks/case	505*355*455	7.5

ROBOTIC TIPS

Compatible with

Hamilton Star , Starlet and Nimbus , Microlab Starplus



Format: 96-tip format
 Tip Volume range selection: 300µl
 Material: Conductive Polypropylene
 Alternatives:
 ● With/without aerosol-barrier filter
 ● Pre-Sterilized/Non-Sterilized
 ● Low Retention/Standard
 Certified:
 DNase-Free, RNase-Free, Endotoxin-Safe

Material: Polypropylene

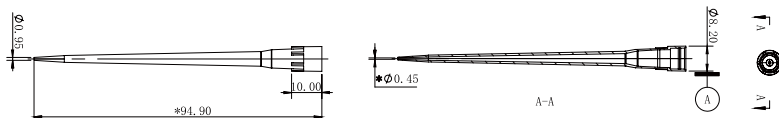
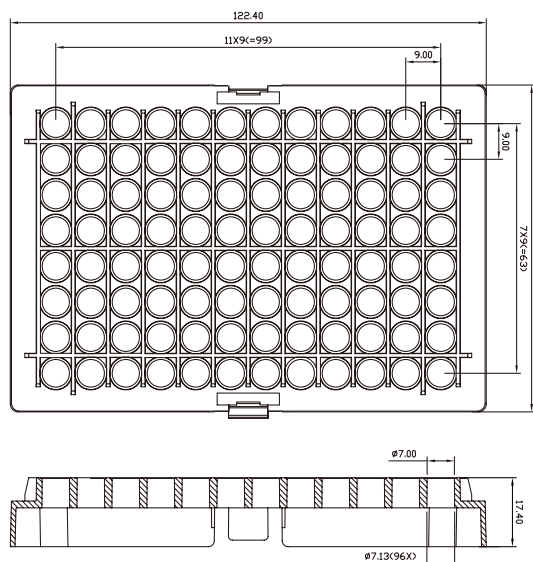

300µl long version

	GEB Cat#	Max Volume	Type	Packaging Specification	Carton Size L*W*H(mm)	Weight KGs
	AT300LH-H-X	300µl	Black	96 tips/rack, 16 racks/case	405*285*235	4.1
	 AT300LH-H-X-LB	300µl	Black Low Retention	96 tips/rack, 16 racks/case	405*285*235	4.1
	AT300LH-H-XS	300µl	Black Pre-Sterilized	96 tips/rack, 16 racks/case	405*285*235	4.1
	 AT300LH-H-XS-LB	300µl	Black Low Retention, Pre-Sterilized	96 tips/rack, 16 racks/case	405*285*235	4.1
	AF300LH-H-XS	300µl	Black Filtered, Pre-Sterilized	96 tips/rack, 16 racks/case	405*285*235	4.1
 AF300LH-H-XS-LB	300µl	Black , Low Retention Filtered, Pre-Sterilized	96 tips/rack, 16 racks/case	405*285*235	4.1	

ROBOTIC TIPS

Compatible with

Hamilton Star , Starlet and Nimbus , Microlab Starplus



Format: 96-tip format
 Tip Volume range selection: 1000µl
 Material: Virgin Polypropylene
 Alternatives:
 ● With/without aerosol-barrier filter
 ● Pre-Sterilized/Non-Sterilized
 ● Low Retention/Standard
 Certified:
 DNase-Free, RNase-Free, Endotoxin-Safe

Material: Polypropylene

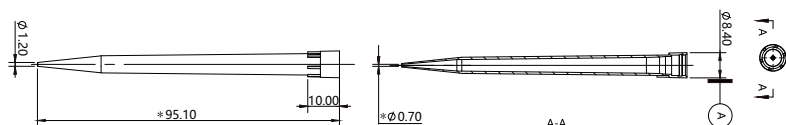
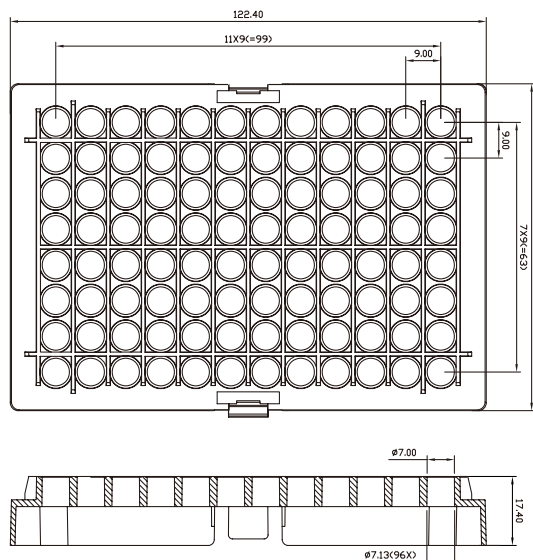

1000µl

	GEB Cat#	Max Volume	Type	Packaging Specification	Carton Size L*W*H(mm)	Weight KGS
	AT01MH-H-N	1000µl	Natural	96 tips/rack, 16 racks/case	405*285*235	4.0
	AT01MH-H-N-LB	1000µl	Natural Low Retention	96 tips/rack, 16 racks/case	405*285*235	4.0
	AT01MH-H-NS	1000µl	Natural Pre-Sterilized	96 tips/rack, 16 racks/case	405*285*235	4.0
	AT01MH-H-NS-LB	1000µl	Natural Low Retention, Pre-Sterilized	96 tips/rack, 16 racks/case	405*285*235	4.0
	AF01MH-H-NS	1000µl	Natural Filtered, Pre-Sterilized	96 tips/rack, 16 racks/case	405*285*235	4.0
	AF01MH-H-NS-LB	1000µl	Natural, Low Retention Filtered, Pre-Sterilized	96 tips/rack, 16 racks/case	405*285*235	4.0
	AT01MH-H2-N	1000µl	Natural	2*96 tips / rack 5 racks / pack, 10 packs/case	465*295*685	17.4
	AT01MH-H2-N-LB	1000µl	Natural Low Retention	2*96 tips / rack 5 racks / pack, 10 packs/case	465*295*685	17.4
	AF01MH-H2-NS	1000µl	Natural Filtered, Pre-Sterilized	2*96 tips / rack 5 racks / pack, 10 packs/case	465*295*685	17.4
	AF01MH-H2-NS-LB	1000µl	Natural, Low Retention Filtered, Pre-Sterilized	2*96 tips / rack 5 racks / pack, 10 packs/case	465*295*685	17.4
	AT01MH-H5-N	1000µl	Natural	96tips/rack 5racks / stack, 8stacks/case	505*355*455	8.5
	AT01MH-H5-N-LB	1000µl	Natural Low Retention	96tips/rack 5racks / stack, 8stacks/case	505*355*455	8.5
	AT01MH-H5-NS	1000µl	Natural Pre-Sterilized	96tips/rack 5racks / stack, 8stacks/case	505*355*455	8.5
	AT01MH-H5-NS-LB	1000µl	Natural Low Retention, Pre-Sterilized	96tips/rack 5racks / stack, 8stacks/case	505*355*455	8.5
	AF01MH-H5-NS	1000µl	Natural Filtered, Pre-Sterilized	96tips/rack 5racks / stack, 8stacks/case	505*355*455	8.5
	AF01MH-H5-NS-LB	1000µl	Natural, Low Retention Filtered, Pre-Sterilized	96tips/rack 5racks / stack, 8stacks/case	505*355*455	8.5

ROBOTIC TIPS

Compatible with

Hamilton Star , Starlet and Nimbus, Microlab Starplus



Format: 96-tip format
 Tip Volume range selection: 1000µl
 Material: Conductive Polypropylene
 Alternatives:
 ● With/without aerosol-barrier filter
 ● Pre-Sterilized/Non-Sterilized
 ● Low Retention/Standard
 Certified:
 DNase-Free, RNase-Free, Endotoxin-Safe

Material: Polypropylene

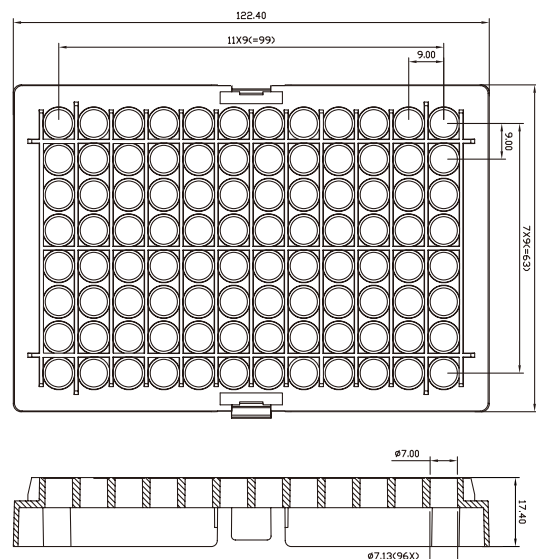
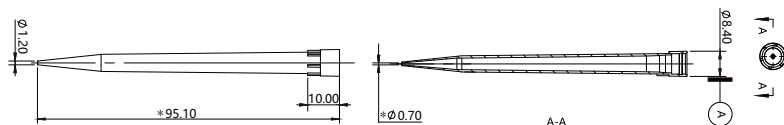

1000µl

	GEB Cat#	Max Volume	Type	Packaging Specification	Carton Size L*W*H(mm)	Weight KGs
	AT01MH-H-X	1000µl	Black	96 tips/rack, 16 racks/case	405*285*235	4.0
	AT01MH-H-X-LB	1000µl	Black Low Retention	96 tips/rack, 16 racks/case	405*285*235	4.0
	AT01MH-H-XS	1000µl	Black Pre-Sterilized	96 tips/rack, 16 racks/case	405*285*235	4.0
	AT01MH-H-XS-LB	1000µl	Black Low Retention, Pre-Sterilized	96 tips/rack, 16 racks/case	405*285*235	4.0
	AFO1MH-H-XS	1000µl	Black Filtered, Pre-Sterilized	96 tips/rack, 16 racks/case	405*285*235	4.0
	AFO1MH-H-XS-LB	1000µl	Black, Low Retention Filtered, Pre-Sterilized	96 tips/rack, 16 racks/case	405*285*235	4.0
	AT01MH-H2-X	1000µl	Black	2*96 tips/rack 5 racks /pack, 10 packs/case	465*295*685	17.4
	AT01MH-H2-X-LB	1000µl	Black Low Retention	2*96 tips/rack 5 racks /pack, 10 packs/case	465*295*685	17.4
	AFO1MH-H2-XS	1000µl	Black Filtered, Pre-Sterilized	2*96 tips/rack 5 racks /pack, 10 packs/case	465*295*685	17.4
	AFO1MH-H2-XS-LB	1000µl	Black , Low Retention Filtered, Pre-Sterilized	2*96 tips/rack 5 racks /pack, 10 packs/case	465*295*685	17.4
	AT01MH-H5-X	1000µl	Black	96 tips/rack 5racks /stack, 8stacks/case	505*355*455	8.5
	AT01MH-H5-X-LB	1000µl	Black Low Retention	96 tips/rack 5racks /stack, 8stacks/case	505*355*455	8.5
	AT01MH-H5-XS	1000µl	Black Pre-Sterilized	96 tips/rack 5racks /stack, 8stacks/case	505*355*455	8.5
	AT01MH-H5-XS-LB	1000µl	Black Low Retention, Pre-Sterilized	96 tips/rack 5racks /stack, 8stacks/case	505*355*455	8.5
	AFO1MH-H5-XS	1000µl	Black Filtered, Pre-Sterilized	96 tips/rack 5racks /stack, 8stacks/case	505*355*455	8.5
	AFO1MH-H5-XS-LB	1000µl	Black, Low Retention Filtered, Pre-Sterilized	96 tips/rack 5racks /stack, 8stacks/case	505*355*455	8.5

ROBOTIC TIPS

Compatible with

Tecan Genesis Freedom , Freedom Evo , Miniprep with LiHa







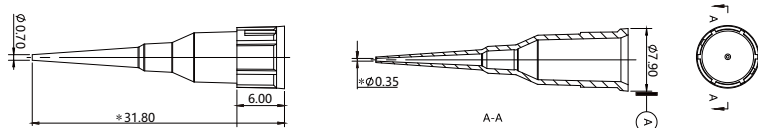
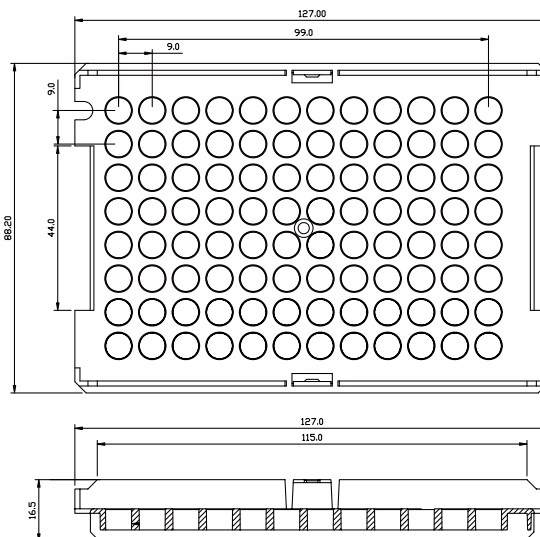







Format: 96-tip format
 Tip Volume range selection: 20µl
 Material: Virgin Polypropylene
 Alternatives:
 ● With/without aerosol-barrier filter
 ● Pre-Sterilized/Non-Sterilized
 ● Low Retention/Standard
 Certified:
 DNase-Free, RNase-Free, Endotoxin-Safe

Material: Polypropylene



20µl

	GEB Cat#	Max Volume	Type	Packaging Specification	Carton Size L*W*H(mm)	Weight KGs
	AT020T-H-N	20µl	Natural	96 tips/rack, 24 racks/case	405*285*235	3.8
	 AT020T-H-N-LB	20µl	Natural Low Retention	96 tips/rack, 24 racks/case	405*285*235	3.8
	AT020T-H-NS	20µl	Natural Pre-Sterilized	96 tips/rack, 24 racks/case	405*285*235	3.8
	 AT020T-H-NS-LB	20µl	Natural Low Retention, Pre-Sterilized	96 tips/rack, 24 racks/case	405*285*235	3.8
	AF020T-H-NS	10µl	Natural Filtered, Pre-Sterilized	96 tips/rack, 24 racks/case	405*285*235	3.8
	 AF020T-H-NS-LB	10µl	Natural, Low Retention Filtered, Pre-Sterilized	96 tips/rack, 24 racks/case	405*285*235	3.8
	AT020T-H2-N	20µl	Natural	2x96 tips/rack 5 racks / pack , 10 packs/case	465*295*345	10.6
	 AT020T-H2-N-LB	20µl	Natural Low Retention	2x96 tips/rack 5 racks / pack , 10 packs/case	465*295*345	10.6
	AF020T-H2-NS	10µl	Natural Filtered, Pre-Sterilized	2x96 tips/rack 5 racks / pack , 10 packs/case	465*295*345	10.6
	 AF020T-H2-NS-LB	10µl	Natural, Low Retention Filtered, Pre-Sterilized	2x96 tips/rack 5 racks / pack , 10 packs/case	465*295*345	10.6
	AT020T-H5-N	20µl	Natural	96 tips / rack 5racks /stack, 12stacks/case	505*355*455	6.3
	 AT020T-H5-N-LB	20µl	Natural Low Retention	96tips /rack 5racks /stack, 12stacks/case	505*355*455	6.3
	AT020T-H5-NS	20µl	Natural Pre-Sterilized	96tips /rack 5racks /stack, 12stacks/case	505*355*455	6.3
	 AT020T-H5-NS-LB	20µl	Natural Low Retention, Pre-Sterilized	96tips /rack 5racks /stack, 12stacks/case	505*355*455	6.3
	AF020T-H5-NS	10µl	Natural Filtered, Pre-Sterilized	96tips /rack 5racks /stack, 12stacks/case	505*355*455	6.3
	 AF020T-H5-NS-LB	10µl	Natural, Low Retention Filtered, Pre-Sterilized	96tips /rack 5racks /stack, 12stacks/case	505*355*455	6.3

ROBOTIC TIPS

Compatible with

Tecan Genesis Freedom , Freedom Evo , Miniprep with LiHa

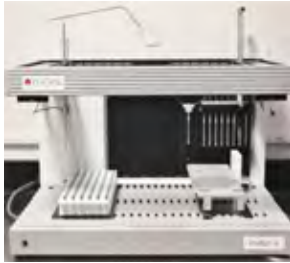

Format: 96-tip format
 Tip Volume range selection: 20µl
 Material: Conductive Polypropylene
 Alternatives:
 ● With/without aerosol-barrier filter
 ● Pre-Sterilized/Non-Sterilized
 ● Low Retention/Standard
 Certified:
 DNase-Free, RNase-Free, Endotoxin-Safe

Material: Polypropylene

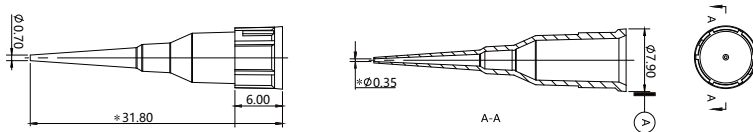
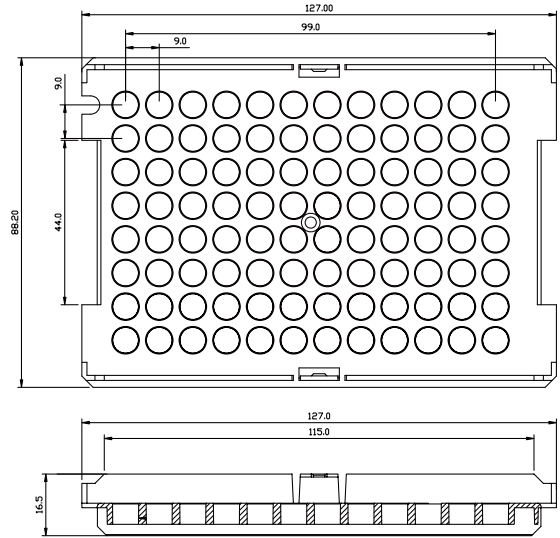

20µl

	GEB Cat#	Max Volume	Type	Packaging Specification	Carton Size L*W*H(mm)	Weight KGs
	AT020T-H-X	20µl	Black	96 tips/rack, 24 racks/case	405*285*235	3.8
	AT020T-H-X-LB	20µl	Black Low Retention	96 tips/rack, 24 racks/case	405*285*235	3.8
	AT020T-H-XS	20µl	Black Pre-Sterilized	96 tips/rack, 24 racks/case	405*285*235	3.8
	AT020T-H-XS-LB	20µl	Black Low Retention, Pre-Sterilized	96 tips/rack, 24 racks/case	405*285*235	3.8
	AF020T-H-XS	10µl	Black Filtered, Pre-Sterilized	96 tips/rack, 24 racks/case	405*285*235	3.8
	AF020T-H-XS-LB	10µl	Black, Low Retention Filtered, Pre-Sterilized	96 tips/rack, 24 racks/case	405*285*235	3.8
	AT020T-H2-X	20µl	Black	2*96 tips/rack 5 racks / pack , 10 packs/case	465*295*345	10.6
	AT020T-H2-X-LB	20µl	Black Low Retention	2*96 tips/rack 5 racks / pack , 10 packs/case	465*295*345	10.6
	AF020T-H2-XS	10µl	Black Filtered, Pre-Sterilized	2*96 tips/rack 5 racks / pack , 10 packs/case	465*295*345	10.6
	AF020T-H2-XS-LB	10µl	Black , Low Retention Filtered, Pre-Sterilized	2*96 tips/rack 5 racks / pack , 10 packs/case	465*295*345	10.6
	AT020T-H5-X	20µl	Black	96 tips / rack 5racks /stack, 12stacks/case	505*355*455	6.3
	AT020T-H5-X-LB	20µl	Black Low Retention	96tips /rack 5racks /stack, 12stacks/case	505*355*455	6.3
	AT020T-H5-XS	20µl	Black Pre-Sterilized	96tips /rack 5racks /stack, 12stacks/case	505*355*455	6.3
	AT020T-H5-XS-LB	20µl	Black Low Retention, Pre-Sterilized	96tips /rack 5racks /stack, 12stacks/case	505*355*455	6.3
	AF020T-H5-XS	10µl	Black Filtered, Pre-Sterilized	96tips /rack 5racks /stack, 12stacks/case	505*355*455	6.3
	AF020T-H5-XS-LB	10µl	Black , Low Retention Filtered, Pre-Sterilized	96tips /rack 5racks /stack, 12stacks/case	505*355*455	6.3

ROBOTIC TIPS

Compatible with

**Tecan Genesis Freedom , Freedom Evo , Miniprep with LiHa
Aquarius ,Te-Mo**



Format: 96-tip format
 Tip Volume range selection: 50µl
 Material: Virgin Polypropylene
 Alternatives:
 ● With/without aerosol-barrier filter
 ● Pre-Sterilized/Non-Sterilized
 ● Low Retention/Standard
 Certified:
 DNase-Free, RNase-Free, Endotoxin-Safe

Material: Polypropylene

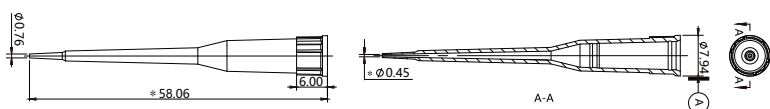
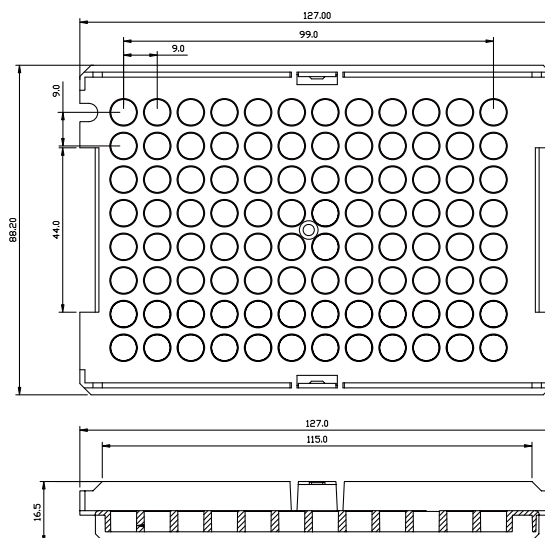

50µl

GEB Cat#	Max Volume	Type	Packaging Specification	Carton Size L*W*H(mm)	Weight KGs
AT050T-H-N	50µl	Natural	96 tips/rack, 24 racks/case	405*285*235	3.8
 AT050T-H-N-LB	50µl	Natural Low Retention	96 tips/rack, 24 racks/case	405*285*235	3.8
AT050T-H-NS	50µl	Natural Pre-Sterilized	96 tips/rack, 24 racks/case	405*285*235	3.8
 AT050T-H-NS-LB	50µl	Natural Low Retention, Pre-Sterilized	96 tips/rack, 24 racks/case	405*285*235	3.8
AF050T-H-NS	50µl	Filtered, Pre-Sterilized Natural, Low Retention	96 tips/rack, 24 racks/case	405*285*235	3.8
 AF050T-H-NS-LB	50µl	Filtered, Pre-Sterilized Natural, Low Retention	96 tips/rack, 24 racks/case	405*285*235	3.8
AT050T-H2-N	50µl	Natural	5 racks / pack, 10 packs / case 2x96 tips/rack	465*295*455	10.6
 AT050T-H2-N-LB	50µl	Natural Low Retention	5 racks / pack, 10 packs / case 2x96 tips/rack	465*295*455	10.6
AF050T-H2-NS	50µl	Filtered, Pre-Sterilized Natural, Low Retention	5 racks / pack, 10 packs / case 96tips/rack	465*295*455	10.6
 AF050T-H2-NS-LB	50µl	Filtered, Pre-Sterilized Natural, Low Retention	5 racks / stack, 12stacks / case 96tips/rack	465*295*455	10.6
AT050T-H5-N	50µl	Natural	5racks / stack, 12stacks / case 96tips/rack	505*355*455	6.8
 AT050T-H5-N-LB	50µl	Natural Low Retention	5racks / stack, 12stacks / case 96tips/rack	505*355*455	6.8
AT050T-H5-NS	50µl	Natural Pre-Sterilized	5racks / stack, 12stacks / case 96tips/rack	505*355*455	6.8
 AT050T-H5-NS-LB	50µl	Natural Low Retention, Pre-Sterilized	5racks / stack, 12stacks / case 96tips/rack	505*355*455	6.8
AF050T-H5-NS	50µl	Filtered, Pre-Sterilized Natural, Low Retention	5racks / stack, 12stacks / case 96tips/rack	505*355*455	6.8
 AF050T-H5-NS-LB	50µl	Filtered, Pre-Sterilized Natural, Low Retention	5racks / stack, 12stacks / case 96tips/rack	505*355*455	6.8
AT050T-9-N	50µl	Natural	96 tips/rack, 10 racks/pack, 4 packs/case	470*280*325	7.75
 AT050T-9-N-LB	50µl	Natural Low Retention	96 tips/rack, 10 racks/pack, 4 packs/case	470*280*325	7.75
AT050T-9-NS	50µl	Natural Pre-Sterilized	96 tips/rack, 10 racks/pack, 4 packs/case	470*280*325	7.75
 AT050T-9-NS-LB	50µl	Natural Low Retention, Pre-Sterilized	96 tips/rack, 10 racks/pack, 4 packs/case	470*280*325	7.75
AF050T-9-NS	50µl	Filtered, Pre-Sterilized Natural, Low Retention	96 tips/rack, 10 racks/pack, 4 packs/case	470*280*325	7.75
 AF050T-9-NS-LB	50µl	Filtered, Pre-Sterilized Natural, Low Retention	96 tips/rack, 10 racks/pack, 4 packs/case	470*280*325	7.75

ROBOTIC TIPS

Compatible with

Tecan Genesis Freedom , Freedom Evo , Miniprep with LiHa Aquarius ,Te-Mo



Format: 96-tip format
 Tip Volume range selection: 50µl
 Material: Conductive Polypropylene
 Alternatives:
 ● With/without aerosol-barrier filter
 ● Pre-Sterilized/Non-Sterilized
 ● Low Retention/Standard
 Certified:
 DNase-Free, RNase-Free, Endotoxin-Safe

Material: Polypropylene

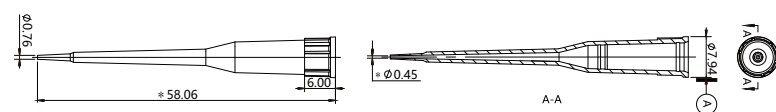
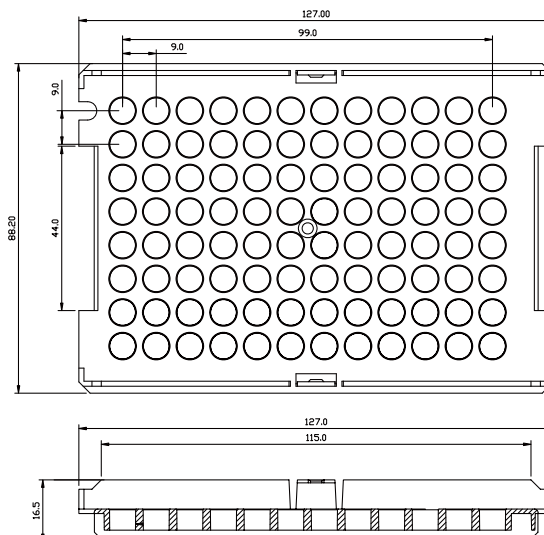

50µl

	GEB Cat#	Max Volume	Type	Packaging Specification	Carton Size L*W*H(mm)	Weight KGs
	AT050T-H-X	50µl	Black	96 tips/rack, 24 racks/case	405*285*235	3.8
	AT050T-H-X-LB	50µl	Black Low Retention	96 tips/rack, 24 racks/case	405*285*235	3.8
	AT050T-H-XS	50µl	Black Pre-Sterilized	96 tips/rack, 24 racks/case	405*285*235	3.8
	AT050T-H-XS-LB	50µl	Black Low Retention, Pre-Sterilized	96 tips/rack, 24 racks/case	405*285*235	3.8
	AF050T-H-XS	50µl	Black Filtered, Pre-Sterilized	96 tips/rack, 24 racks/case	405*285*235	3.8
	AF050T-H-XS-LB	50µl	Black, Low Retention Filtered, Pre-Sterilized	96 tips/rack, 24 racks/case	405*285*235	3.8
	AT050T-H2-X	50µl	Black	2x96 tips/rack 5 racks / pack ,10 packs/case	465*295*455	10.6
	AT050T-H2-X-LB	50µl	Black Low Retention	2x96 tips/rack 5 racks / pack ,10 packs/case	465*295*455	10.6
	AF050T-H2-XS	50µl	Black Filtered, Pre-Sterilized	2x96 tips/rack 5 racks / pack ,10 packs/case	465*295*455	10.6
	AF050T-H2-XS-LB	50µl	Black, Low Retention Filtered, Pre-Sterilized	96tips/rack 5racks /stack,12stacks /case	465*295*455	10.6
	AT050T-H5-X	50µl	Black	96tips/rack 5racks /stack,12stacks /case	505*355*455	6.8
	AT050T-H5-X-LB	50µl	Black Low Retention	96tips/rack 5racks /stack,12stacks /case	505*355*455	6.8
	AT050T-H5-XS	50µl	Pre-Sterilized	96tips/rack 5racks /stack,12stacks /case	505*355*455	6.8
	AT050T-H5-XS-LB	50µl	Black Low Retention, Pre-Sterilized	96tips/rack 5racks /stack,12stacks /case	505*355*455	6.8
	AF050T-H5-XS	50µl	Black Filtered, Pre-Sterilized	96tips/rack 5racks /stack,12stacks /case	505*355*455	6.8
	AF050T-H5-XS-LB	50µl	Black, Low Retention Filtered, Pre-Sterilized	96tips/rack 5racks /stack,12stacks /case	505*355*455	6.8
	AT050T-9-X	50µl	Black	96 tips/rack, 10 racks/pack, 4 packs/case	470*280*325	7.75
	AT050T-9-X-LB	50µl	Black Low Retention	96 tips/rack, 10 racks/pack, 4 packs/case	470*280*325	7.75
	AT050T-9-XS	50µl	Black Pre-Sterilized	96 tips/rack, 10 racks/pack, 4 packs/case	470*280*325	7.75
	AT050T-9-XS-LB	50µl	Black Low Retention, Pre-Sterilized	96 tips/rack, 10 racks/pack, 4 packs/case	470*280*325	7.75
	AF050T-9-XS	50µl	Black Filtered, Pre-Sterilized	96 tips/rack, 10 racks/pack, 4 packs/case	470*280*325	7.75
	AF050T-9-XS-LB	50µl	Black, Low Retention Filtered, Pre-Sterilized	96 tips/rack, 10 racks/pack, 4 packs/case	470*280*325	7.75

ROBOTIC TIPS

Compatible with

**Tecan Genesis Freedom , Freedom Evo , Miniprep with LiHa
Aquarius ,Te-Mo**



Format: 96-tip format
 Tip Volume range selection: 200µl
 Material: Virgin Polypropylene
 Alternatives:
 ● With/without aerosol-barrier filter
 ● Pre-Sterilized/Non-Sterilized
 ● Low Retention/Standard
 Certified:
 DNase-Free, RNase-Free, Endotoxin-Safe

Material: Polypropylene

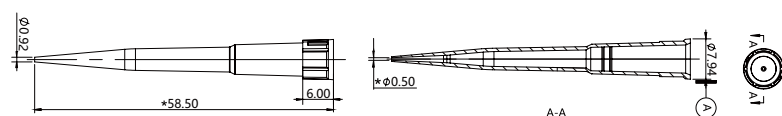
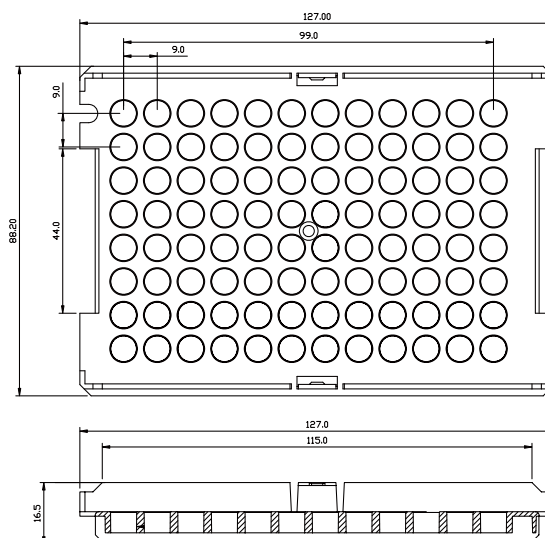

200µl

	GEB Cat#	Max Volume	Type	Packaging Specification	Carton Size L*W*H(mm)	Weight KGs
	AT200T-H-N	200µl	Natural	96 tips/rack, 24 racks/case	405*285*235	4.5
	AT200T-H-N-LB	200µl	Natural Low Retention	96 tips/rack, 24 racks/case	405*285*235	4.5
	AT200T-H-NS	200µl	Natural Pre-Sterilized	96 tips/rack, 24 racks/case	405*285*235	4.5
	AT200T-H-NS-LB	200µl	Natural Low Retention, Pre-Sterilized	96 tips/rack, 24 racks/case	405*285*235	4.5
	AF200T-H-NS	200µl	Natural Filtered, Pre-Sterilized	96 tips/rack, 24 racks/case	405*285*235	4.5
	AF200T-H-NS-LB	200µl	Natural, Low Retention Filtered, Pre-Sterilized	96 tips/rack, 24 racks/case	405*285*235	4.5
	AT200T-H2-N	200µl	Natural	5 racks / pack , 10 packs / case 2x96 tips/rack	465*295*455	11.6
	AT200T-H2-N-LB	200µl	Natural Low Retention	5 racks / pack , 10 packs / case 2x96 tips/rack	465*295*455	11.6
	AF200T-H2-NS	200µl	Natural Filtered, Pre-Sterilized	5 racks / pack , 10 packs / case 96tips/rack	465*295*455	11.6
	AF200T-H2-NS-LB	200µl	Natural, Low Retention Filtered, Pre-Sterilized	5racks /stack,12stacks /case 96tips/rack	465*295*455	11.6
	AT200T-H5-N	200µl	Natural	5racks /stack,12stacks /case 96tips/rack	505*355*455	7.5
	AT200T-H5-N-LB	200µl	Natural Low Retention	5racks /stack,12stacks /case 96tips/rack	505*355*455	7.5
	AT200T-H5-NS	200µl	Natural Pre-Sterilized	5racks /stack,12stacks /case 96tips/rack	505*355*455	7.5
	AT200T-H5-NS-LB	200µl	Natural Low Retention, Pre-Sterilized	5racks /stack,12stacks /case 96tips/rack	505*355*455	7.5
	AF200T-H5-NS	200µl	Natural Filtered, Pre-Sterilized	5racks /stack,12stacks /case 96tips/rack	505*355*455	7.5
	AF200T-H5-NS-LB	200µl	Natural, Low Retention Filtered, Pre-Sterilized	5racks /stack,12stacks /case 96tips/rack	505*355*455	7.5
	AT200T-9-N	200µl	Natural	96 tips/rack, 10 racks/pack, 4 packs/case	470*280*325	7.9
	AT200T-9-N-LB	200µl	Natural Low Retention	96 tips/rack, 10 racks/pack, 4 packs/case	470*280*325	7.9
	AT200T-9-NS	200µl	Natural Pre-Sterilized	96 tips/rack, 10 racks/pack, 4 packs/case	470*280*325	7.9
	AT200T-9-NS-LB	200µl	Natural Low Retention, Pre-Sterilized	96 tips/rack, 10 racks/pack, 4 packs/case	470*280*325	7.9
	AF200T-9-NS	200µl	Natural Filtered, Pre-Sterilized	96 tips/rack, 10 racks/pack, 4 packs/case	470*280*325	7.9
	AF200T-9-NS-LB	200µl	Natural, Low Retention Filtered, Pre-Sterilized	96 tips/rack, 10 racks/pack, 4 packs/case	470*280*325	7.9

ROBOTIC TIPS

Compatible with

Tecan Genesis Freedom , Freedom Evo , Miniprep with LiHa
Aquarius ,Te-Mo



Format: 96-tip format
 Tip Volume range selection: 200µl
 Material: Conductive Polypropylene
 Alternatives:
 ● With/without aerosol-barrier filter
 ● Pre-Sterilized/Non-Sterilized
 ● Low Retention/Standard
 Certified:
 DNase-Free, RNase-Free, Endotoxin-Safe

Material: Polypropylene

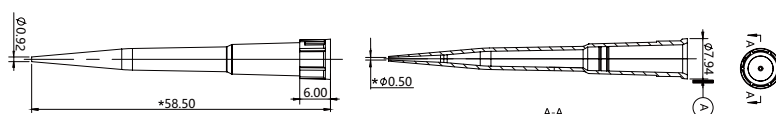
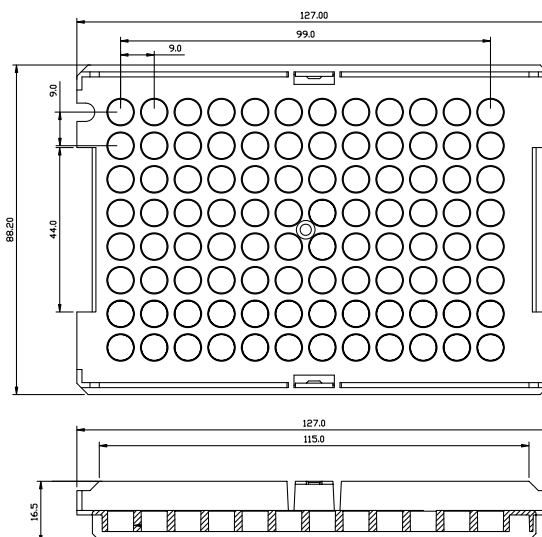

200µl

	GEB Cat#	Max Volume	Type	Packaging Specification	Carton Size L*W*H(mm)	Weight KGs
	AT200T-H-X	200µl	Black	96 tips/rack, 24 racks per case	405*285*235	4.5
	AT200T-H-X-LB	200µl	Black Low Retention	96 tips/rack, 24 racks per case	405*285*235	4.5
	AT200T-H-XS	200µl	Black Pre-Sterilized	96 tips/rack, 24 racks per case	405*285*235	4.5
	AT200T-H-XS-LB	200µl	Black Low Retention, Pre-Sterilized	96 tips/rack, 24 racks per case	405*285*235	4.5
	AF200T-H-XS	200µl	Black Filtered, Pre-Sterilized	96 tips/rack, 24 racks per case	405*285*235	4.5
	AF200T-H-XS-LB	200µl	Black, Low Retention Filtered, Pre-Sterilized	96 tips/rack, 24 racks per case	405*285*235	4.5
	AT200T-H2-X	200µl	Black	5 racks per pack, 10 packs per case 2*96 tips per rack	465*295*455	11.6
	AT200T-H2-X-LB	200µl	Black Low Retention	5 racks per pack, 10 packs per case 2*96 tips per rack	465*295*455	11.6
	AF200T-H2-XS	200µl	Black Filtered, Pre-Sterilized	5 racks per pack, 10 packs per case 2*96 tips per rack	465*295*455	11.6
	AF200T-H2-XS-LB	200µl	Black, Low Retention Filtered, Pre-Sterilized	5 racks per pack, 10 packs per case 2*96 tips per rack	465*295*455	11.6
	AT200T-H5-X	200µl	Black	96tips per rack 5racks per stack, 12stacks per case	505*355*455	7.5
	AT200T-H5-X-LB	200µl	Black Low Retention	96tips per rack 5racks per stack, 12stacks per case	505*355*455	7.5
	AT200T-H5-XS	200µl	Pre-Sterilized	96tips per rack 5racks per stack, 12stacks per case	505*355*455	7.5
	AT200T-H5-XS-LB	200µl	Black Low Retention, Pre-Sterilized	96tips per rack 5racks per stack, 12stacks per case	505*355*455	7.5
	AF200T-H5-XS	200µl	Black Filtered, Pre-Sterilized	96tips per rack 5racks per stack, 12stacks per case	505*355*455	7.5
	AF200T-H5-XS-LB	200µl	Black, Low Retention Filtered, Pre-Sterilized	96tips per rack 5racks per stack, 12stacks per case	505*355*455	7.5
	AT200T-9-X	200µl	Black	96 tips/rack, 10 racks/pack, 4 packs/case	470*280*325	7.9
	AT200T-9-X-LB	200µl	Black Low Retention	96 tips/rack, 10 racks/pack, 4 packs/case	470*280*325	7.9
	AT200T-9-XS	200µl	Black Pre-Sterilized	96 tips/rack, 10 racks/pack, 4 packs/case	470*280*325	7.9
	AT200T-9-XS-LB	200µl	Black Low Retention, Pre-Sterilized	96 tips/rack, 10 racks/pack, 4 packs/case	470*280*325	7.9
AF200T-9-XS	200µl	Black Filtered, Pre-Sterilized	96 tips/rack, 10 racks/pack, 4 packs/case	470*280*325	7.9	
AF200T-9-XS-LB	200µl	Black, Low Retention Filtered, Pre-Sterilized	96 tips/rack, 10 racks/pack, 4 packs/case	470*280*325	7.9	

ROBOTIC TIPS

Compatible with

Tecan Genesis Freedom , Freedom Evo , Miniprep with LiHa



Format: 96-tip format
 Tip Volume range selection: 1000µl
 Material: Virgin Polypropylene
 Alternatives:
 ● With/without aerosol-barrier filter
 ● Pre-Sterilized/Non-Sterilized
 ● Low Retention/Standard
 Certified:
 DNase-Free, RNase-Free, Endotoxin-Safe

Material: Polypropylene

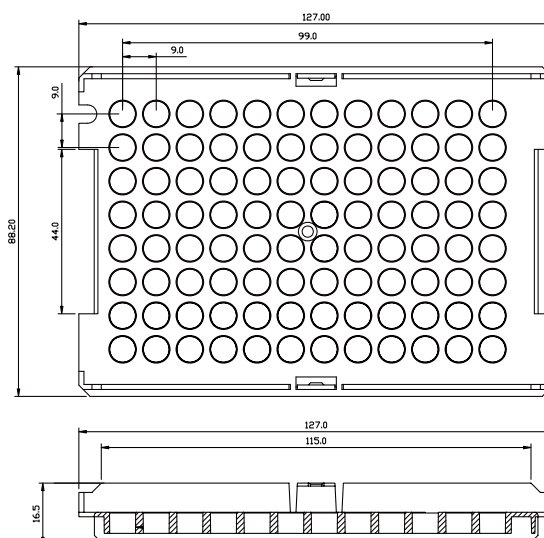

1000µl

GEB Cat#	Max Volume	Type	Packaging Specification	Carton Size L*W*H(mm)	Weight KGS
ATO1MT2-H-N	1000µl	Natural	96 tips/rack, 16 racks/case	405*285*235	4.2
 ATO1MT2-H-N-LB	1000µl	Natural Low Retention	96 tips/rack, 16 racks/case	405*285*235	4.2
ATO1MT2-H-NS	1000µl	Natural Pre-Sterilized	96 tips/rack, 16 racks/case	405*285*235	4.2
 ATO1MT2-H-NS-LB	1000µl	Natural Low Retention, Pre-Sterilized	96 tips/rack, 16 racks/case	405*285*235	4.2
AFO1MT2-H-NS	1000µl	Filtered, Pre-Sterilized	96 tips/rack, 16 racks/case	405*285*235	4.2
 AFO1MT2-H-NS-LB	1000µl	Natural, Low Retention Filtered, Pre-Sterilized	96 tips/rack, 16 racks/case	405*285*235	4.2
ATO1MT2-H2-N	1000µl	Natural	2x96 tips per rack 5 racks per pack, 10 packs per case	685*295*465	17.4
 ATO1MT2-H2-N-LB	1000µl	Natural Low Retention	2x96 tips per rack 5 racks per pack, 10 packs per case	685*295*465	17.4
AFO1MT2-H2-NS	1000µl	Filtered, Pre-Sterilized	5 racks per pack, 10 packs per case	685*295*465	17.4
 AFO1MT2-H2-NS-LB	1000µl	Natural, Low Retention Filtered, Pre-Sterilized	2x96 tips per rack 5 racks per pack, 10 packs per case	685*295*465	17.4
ATO1MT2-H5-N	1000µl	Natural	96tips / rack 5racks / stack, 8stacks / case	505*355*455	8.5
 ATO1MT2-H5-N-LB	1000µl	Natural Low Retention	96tips / rack 5racks / stack, 8stacks / case	505*355*455	8.5
ATO1MT2-H5-NS	1000µl	Natural Pre-Sterilized	96tips / rack 5racks / stack, 8stacks / case	505*355*455	8.5
 ATO1MT2-H5-NS-LB	1000µl	Natural Low Retention, Pre-Sterilized	96tips / rack 5racks / stack, 8stacks / case	505*355*455	8.5
AFO1MT2-H5-NS	1000µl	Filtered, Pre-Sterilized	96tips / rack 5racks / stack, 8stacks / case	505*355*455	8.5
 AFO1MT2-H5-NS-LB	1000µl	Natural, Low Retention Filtered, Pre-Sterilized	96tips / rack 5racks / stack, 8stacks / case	505*355*455	8.5
ATO1MT2-9-N	1000µl	Natural	96 tips/rack, 10 racks/pack, 4 packs/case	470*280*325	10.6
 ATO1MT2-9-N-LB	1000µl	Natural Low Retention	96 tips/rack, 10 racks/pack, 4 packs/case	470*280*325	10.6
ATO1MT2-9-NS	1000µl	Natural Pre-Sterilized	96 tips/rack, 10 racks/pack, 4 packs/case	470*280*325	10.6
 ATO1MT2-9-NS-LB	1000µl	Natural Low Retention, Pre-Sterilized	96 tips/rack, 10 racks/pack, 4 packs/case	470*280*325	10.6
AFO1MT2-9-NS	1000µl	Filtered, Pre-Sterilized	96 tips/rack, 10 racks/pack, 4 packs/case	470*280*325	10.6
 AFO1MT2-9-NS-LB	1000µl	Natural, Low Retention Filtered, Pre-Sterilized	96 tips/rack, 10 racks/pack, 4 packs/case	470*280*325	10.6

ROBOTIC TIPS

Compatible with

Tecan Genesis Freedom , Freedom Evo , Miniprep with LiHa



Format: 96-tip format
 Tip Volume range selection: 1000µl
 Material: Conductive Polypropylene
 Alternatives:
 ● With/without aerosol-barrier filter
 ● Pre-Sterilized/Non-Sterilized
 ● Low Retention/Standard
 Certified:
 DNase-Free, RNase-Free, Endotoxin-Safe

Material: Polypropylene

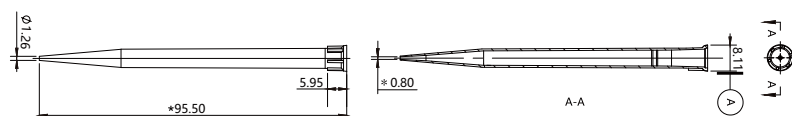
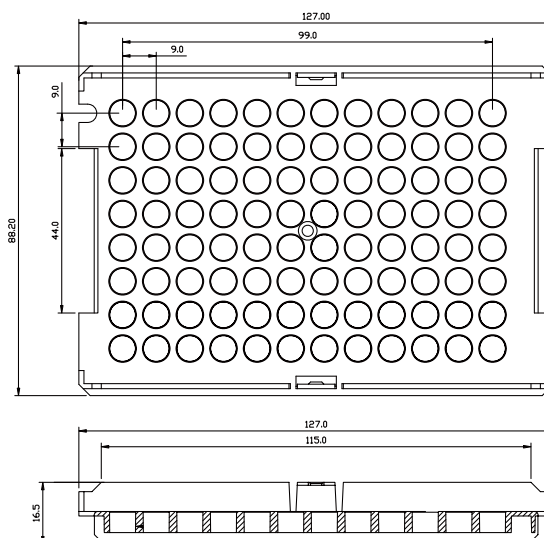

1000µl

	GEB Cat#	Max Volume	Type	Packaging Specification	Carton Size L*W*H(mm)	Weight KGS
	ATO1MT2-H-X	1000µl	Black	96 tips/rack, 16 racks/case	405*285*235	4.2
	ATO1MT2-H-X-LB	1000µl	Black Low Retention	96 tips/rack, 16 racks/case	405*285*235	4.2
	ATO1MT2-H-XS	1000µl	Black Pre-Sterilized	96 tips/rack, 16 racks/case	405*285*235	4.2
	ATO1MT2-H-XS-LB	1000µl	Black Low Retention, Pre-Sterilized	96 tips/rack, 16 racks/case	405*285*235	4.2
	AFO1MT2-H-XS	1000µl	Black Filtered, Pre-Sterilized	96 tips/rack, 16 racks/case	405*285*235	4.2
	AFO1MT2-H-XS-LB	1000µl	Black Filtered, Pre-Sterilized Low Retention	96 tips/rack, 16 racks/case	405*285*235	4.2
	ATO1MT2-H2-X	1000µl	Black	2x96 tips per rack 5 racks per pack, 10 packs per case	685*295*465	17.4
	ATO1MT2-H2-X-LB	1000µl	Black Low Retention	2x96 tips per rack 5 racks per pack, 10 packs per case	685*295*465	17.4
	AFO1MT2-H2-XS	1000µl	Black Filtered, Pre-Sterilized	2x96 tips per rack 5 racks per pack, 10 packs per case	685*295*465	17.4
	AFO1MT2-H2-XS-LB	1000µl	Black Filtered, Pre-Sterilized Low Retention	2x96 tips per rack 5 racks per pack, 10 packs per case	685*295*465	17.4
	ATO1MT2-H5-X	1000µl	Black	96tips / rack 5racks / stack, 8stacks / case	505*355*455	8.5
	ATO1MT2-H5-X-LB	1000µl	Black Low Retention	96tips / rack 5racks / stack, 8stacks / case	505*355*455	8.5
	ATO1MT2-H5-XS	1000µl	Pre-Sterilized	96tips / rack 5racks / stack, 8stacks / case	505*355*455	8.5
	ATO1MT2-H5-XS-LB	1000µl	Black Low Retention, Pre-Sterilized	96tips / rack 5racks / stack, 8stacks / case	505*355*455	8.5
	AFO1MT2-H5-XS	1000µl	Black Filtered, Pre-Sterilized	96tips / rack 5racks / stack, 8stacks / case	505*355*455	8.5
	AFO1MT2-H5-XS-LB	1000µl	Black Filtered, Pre-Sterilized Low Retention	96tips / rack 5racks / stack, 8stacks / case	505*355*455	8.5
	ATO1MT2-9-X	1000µl	Black	96 tips/rack, 10 racks/pack, 4 packs/case	470*280*325	10.6
	ATO1MT2-9-X-LB	1000µl	Black Low Retention	96 tips/rack, 10 racks/pack, 4 packs/case	470*280*325	10.6
	ATO1MT2-9-XS	1000µl	Black Pre-Sterilized	96 tips/rack, 10 racks/pack, 4 packs/case	470*280*325	10.6
	ATO1MT2-9-XS-LB	1000µl	Black Low Retention, Pre-Sterilized	96 tips/rack, 10 racks/pack, 4 packs/case	470*280*325	10.6
AFO1MT2-9-XS	1000µl	Black Filtered, Pre-Sterilized	96 tips/rack, 10 racks/pack, 4 packs/case	470*280*325	10.6	
AFO1MT2-9-XS-LB	1000µl	Black Filtered, Pre-Sterilized Low Retention	96 tips/rack, 10 racks/pack, 4 packs/case	470*280*325	10.6	

ROBOTIC TIPS

Compatible with
Tecan MCA



Format: 96-tip format
 Tip Volume range selection: 50µl
 Material: Virgin Polypropylene
 Alternatives:
 ● With/without aerosol-barrier filter
 ● Pre-Sterilized/Non-Sterilized
 ● Low Retention/Standard
 Certified:
 DNase-Free, RNase-Free, Endotoxin-Safe

Material: Polypropylene

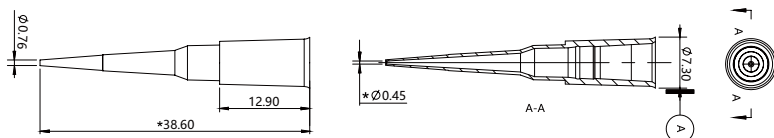
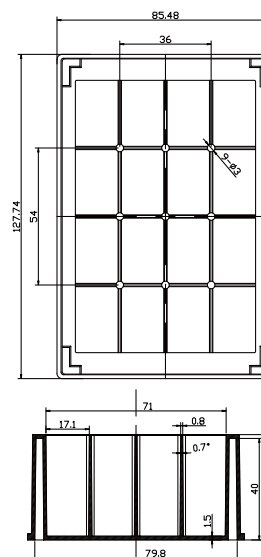

50µl

	GEB Cat#	Max Volume	Type	Packaging Specification	Carton Size L*W*H(mm)	Weight KGs
	AT050M-9-N	50µl	Natural	96 tips/rack, 10 racks/pack, 5 packs/case	480*345*280	10.5
	AT050M-9-N-LB	50µl	Natural Low Retention	96 tips/rack, 10 racks/pack, 5 packs/case	480*345*280	10.5
	AT050M-9-NS	50µl	Natural Pre-Sterilized	96 tips/rack, 10 racks/pack, 5 packs/case	480*345*280	10.5
	AT050M-9-NS-LB	50µl	Natural Low Retention Pre-Sterilized	96 tips/rack, 10 racks/pack, 5 packs/case	480*345*280	10.5
	AF050M-9-NS	50µl	Natural Filtered, Pre-Sterilized	96 tips/rack, 10 racks/pack, 5 packs/case	480*345*280	10.5
	AF050M-9-NS-LB	50µl	Natural Low Retention Filtered, Pre-Sterilized	96 tips/rack, 10 racks/pack, 5 packs/case	480*345*280	10.5
	AT050M-9N-N	50µl	Natural	96 tips/rack, 8 racks /stack, 10 stacks/case	515*310*215	7.2
	AT050M-9N-N-LB	50µl	Natural Low Retention	96 tips/rack, 8 racks /stack, 10 stacks/case	515*310*215	7.2

ROBOTIC TIPS

Compatible with
Tecan MCA



Format: 96-tip format
 Tip Volume range selection: 200µl
 Material: Virgin Polypropylene
 Alternatives:
 ● With/without aerosol-barrier filter
 ● Pre-Sterilized/Non-Sterilized
 ● Low Retention/Standard
 Certified:
 DNase-Free, RNase-Free, Endotoxin-Safe

Material: Polypropylene

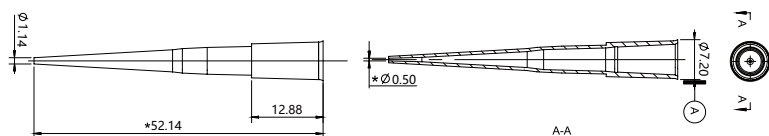
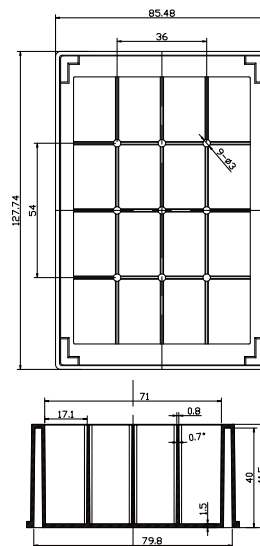

200µl

	GEB Cat#	Max Volume	Type	Packaging Specification	Carton Size L*W*H(mm)	Weight KGs
	AT200M-9-N	200µl	Natural	96 tips/rack, 10 racks/pack, 5 packs/case	480*345*280	10.5
	AT200M-9-N-LB	200µl	Natural Low Retention	96 tips/rack, 10 racks/pack, 5 packs/case	480*345*280	10.5
	AT200M-9-NS	200µl	Natural Pre-Sterilized	96 tips/rack, 10 racks/pack, 5 packs/case	480*345*280	10.5
	AT200M-9-NS-LB	200µl	Natural Low Retention Pre-Sterilized	96 tips/rack, 10 racks/pack, 5 packs/case	480*345*280	10.5
	AF200M-9-NS	180µl	Natural Filtered, Pre-Sterilized	96 tips/rack, 10 racks/pack, 5 packs/case	480*345*280	10.5
	AF200M-9-NS-LB	180µl	Natural Low Retention Filtered, Pre-Sterilized	96 tips/rack, 10 racks/pack, 5 packs/case	480*345*280	10.5
	AT200M-9N-N	200µl	Natural	96 tips/rack, 8 racks /stack, 10 stacks/case	515*310*215	7.2
	AT200M-9N-N-LB	200µl	Natural Low Retention	96 tips/rack, 8 racks /stack, 10 stacks/case	515*310*215	7.2

ROBOTIC TIPS

Compatible with

PerkinElmer Janus , MultiProbe
Evolution P3 ,MiniTrak ,Multiprobe II HT/ET

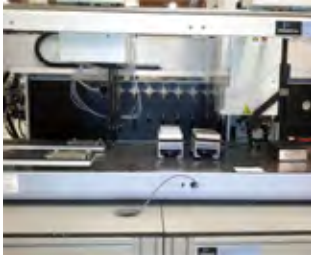

Format: 96-tip format
 Tip Volume range selection: 20µl
 Material: Virgin Polypropylene
 Alternatives:
 ● With/without aerosol-barrier filter
 ● Pre-Sterilized/Non-Sterilized
 ● Low Retention/Standard
 Certified:
 DNase-Free, RNase-Free, Endotoxin-Safe

Material: Polypropylene

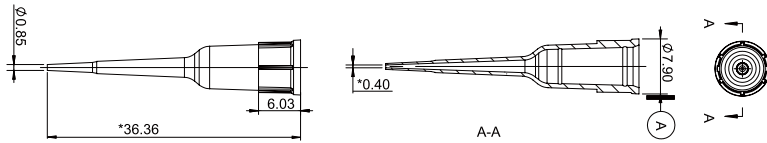
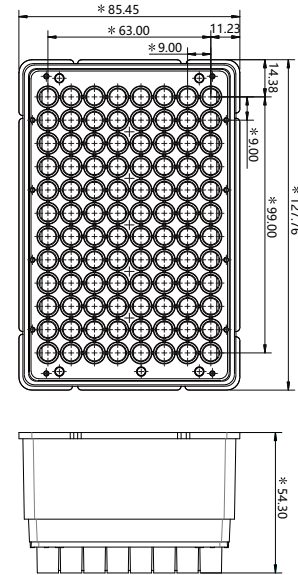

20µl

	GEB Cat#	Max Volume	Type	Packaging Specification	Carton Size L*W*H(mm)	Weight KGs
	AT020P-9-N	20µl	Natural	96 tips/rack, 10 racks/pack, 5 packs/case	500*285*405	10.0
	 AT020P-9-N-LB	20µl	Natural Low Retention	96 tips/rack, 10 racks/pack, 5 packs/case	500*285*405	10.0
	AT020P-9-NS	20µl	Natural Pre-Sterilized	96 tips/rack, 10 racks/pack, 5 packs/case	500*285*405	10.0
	 AT020P-9-NS-LB	20µl	Natural Low Retention Pre-Sterilized	96 tips/rack, 10 racks/pack, 5 packs/case	500*285*405	10.0
	AF020P-9-NS	10µl	Natural Filtered, Pre-Sterilized	96 tips/rack, 10 racks/pack, 5 packs/case	500*285*405	10.0
	 AF020P-9-NS-LB	10µl	Natural Low Retention Filtered, Pre-Sterilized	96 tips/rack, 10 racks/pack, 5 packs/case	500*285*405	10.0

ROBOTIC TIPS

Compatible with

PerkinElmer Janus , MultiProbe
Evolution P3 ,MiniTrak ,Multiprobe II HT/ET

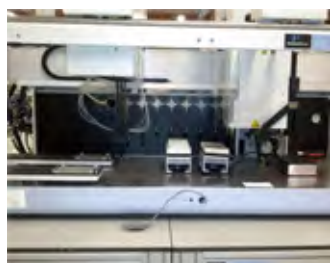

Format: 96-tip format
Tip Volume range selection: 20µl
Material: Conductive Polypropylene
Alternatives:

- With/without aerosol-barrier filter
- Pre-Sterilized/Non-Sterilized
- Low Retention/Standard

 Certified:
DNase-Free, RNase-Free, Endotoxin-Safe

Material: Polypropylene

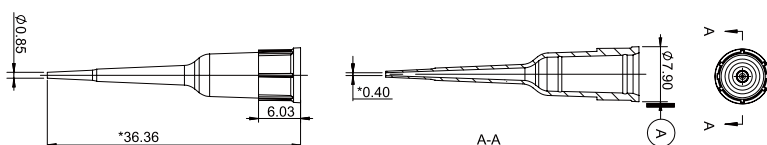
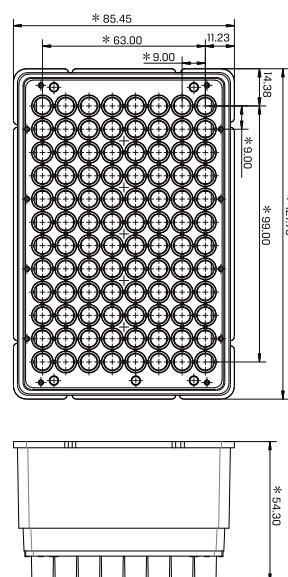

20µl

	GEB Cat#	Max Volume	Type	Packaging Specification	Carton Size L*W*H(mm)	Weight KGs
	AT020P-9-X	20µl	Black	96 tips/rack, 10 racks/pack, 5 packs/case	500*285*405	10.0
	 AT020P-9-X-LB	20µl	Black Low Retention	96 tips/rack, 10 racks/pack, 5 packs/case	500*285*405	10.0
	AT020P-9-XS	20µl	Black Pre-Sterilized	96 tips/rack, 10 racks/pack, 5 packs/case	500*285*405	10.0
	 AT020P-9-XS-LB	20µl	Black Low Retention Pre-Sterilized	96 tips/rack, 10 racks/pack, 5 packs/case	500*285*405	10.0
	AF020P-9-XS	10µl	Black Filtered, Pre-Sterilized	96 tips/rack, 10 racks/pack, 5 packs/case	500*285*405	10.0
	 AF020P-9-XS-LB	10µl	Black Low Retention Filtered, Pre-Sterilized	96 tips/rack, 10 racks/pack, 5 packs/case	500*285*405	10.0

ROBOTIC TIPS

Compatible with

PerkinElmer Janus , MultiProbe

Evolution P3 ,MiniTrak ,Multiprobe II HT/ET ,Sciclone ,Zephyr ,RapidPlate

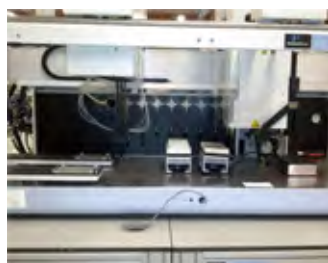

Format: 96-tip format
 Tip Volume range selection: 50µl
 Material: Virgin Polypropylene
 Alternatives:
 ○ With/without aerosol-barrier filter
 ○ Pre-Sterilized/Non-Sterilized
 ○ Low Retention/Standard
 Certified:
 DNase-Free, RNase-Free, Endotoxin-Safe

Material: Polypropylene

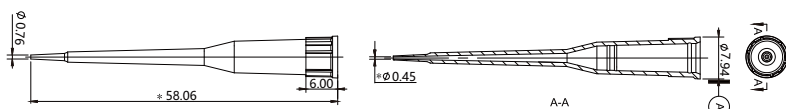
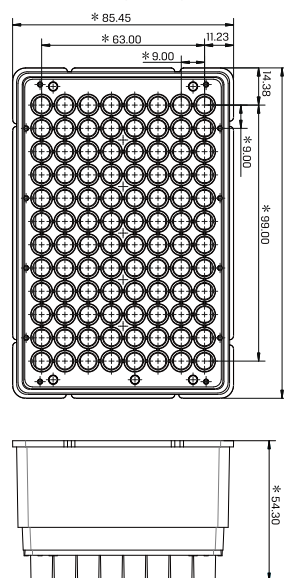

50µl

	GEB Cat#	Max Volume	Type	Packaging Specification	Carton Size L*W*H(mm)	Weight KGs
	AT050P-9-N	50µl	Natural	96 tips/rack, 10 racks/pack, 5 packs/case	500*285*405	10.0
	AT050P-9-N-LB	50µl	Natural Low Retention	96 tips/rack, 10 racks/pack, 5 packs/case	500*285*405	10.0
	AT050P-9-NS	50µl	Natural Pre-Sterilized	96 tips/rack, 10 racks/pack, 5 packs/case	500*285*405	10.0
	AT050P-9-NS-LB	50µl	Natural Low Retention Pre-Sterilized	96 tips/rack, 10 racks/pack, 5 packs/case	500*285*405	10.0
	AF050P-9-NS	30µl	Natural Filtered, Pre-Sterilized	96 tips/rack, 10 racks/pack, 5 packs/case	500*285*405	10.0
	AF050P-9-NS-LB	30µl	Natural Low Retention Filtered, Pre-Sterilized	96 tips/rack, 10 racks/pack, 5 packs/case	500*285*405	10.0

ROBOTIC TIPS

Compatible with

PerkinElmer Janus , MultiProbe

Evolution P3 ,MiniTrak ,Multiprobe II HT/ET ,Sciclone ,Zephyr ,RapidPlate



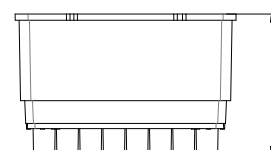
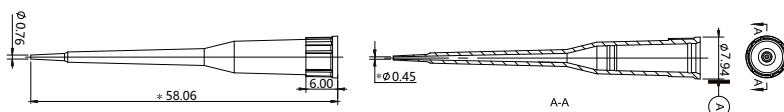
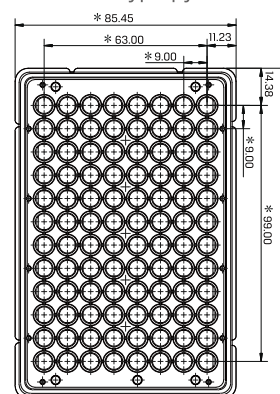

Format: 96-tip format
 Tip Volume range selection: 50µl
 Material: Conductive Polypropylene
 Alternatives:
 ○ With/without aerosol-barrier filter
 ○ Pre-Sterilized/Non-Sterilized
 ○ Low Retention/Standard
 Certified:
 DNase-Free, RNase-Free, Endotoxin-Safe

Material: Polypropylene



50µl

GEB Cat#	Max Volume	Type	Packaging Specification	Carton Size L*W*H(mm)	Weight KGs
AT050P-9-X	50µl	Black	96 tips/rack, 10 racks/pack, 5 packs/case	500*285*405	10.0
 AT050P-9-X-LB	50µl	Black Low Retention	96 tips/rack, 10 racks/pack, 5 packs/case	500*285*405	10.0
AT050P-9-XS	50µl	Black Pre-Sterilized	96 tips/rack, 10 racks/pack, 5 packs/case	500*285*405	10.0
 AT050P-9-XS-LB	50µl	Black Low Retention Pre-Sterilized	96 tips/rack, 10 racks/pack, 5 packs/case	500*285*405	10.0
AF050P-9-XS	30µl	Black Filtered, Pre-Sterilized	96 tips/rack, 10 racks/pack, 5 packs/case	500*285*405	10.0
 AF050P-9-XS-LB	30µl	Black Low Retention Filtered, Pre-Sterilized	96 tips/rack, 10 racks/pack, 5 packs/case	500*285*405	10.0



ROBOTIC TIPS

Compatible with

PerkinElmer Janus , MultiProbe
 Multiprobe II HT/ET ,Sciclone ,Zephyr ,RapidPlate

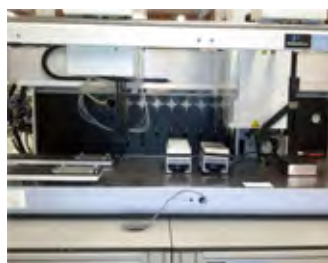

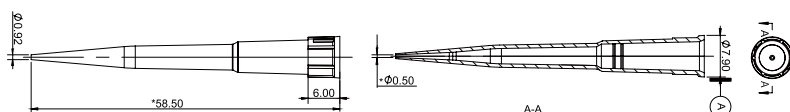
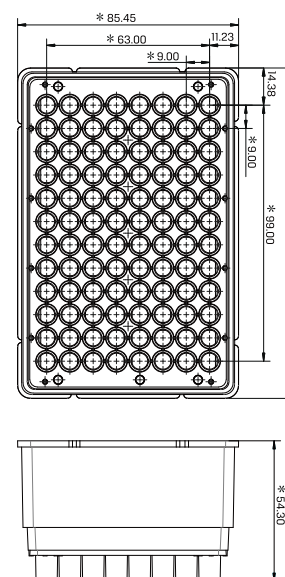

Format: 96-tip format
 Tip Volume range selection: 200µl
 Material: Virgin Polypropylene
 Alternatives:
 ○ With/without aerosol-barrier filter
 ○ Pre-Sterilized/Non-Sterilized
 ○ Low Retention/Standard
 Certified:
 DNase-Free, RNase-Free, Endotoxin-Safe

Material: Polypropylene



200µl

GEB Cat#	Max Volume	Type	Packaging Specification	Carton Size L*W*H(mm)	Weight KGs
AT200P-9-N	200µl	Natural	96 tips/rack, 10 racks/pack, 5 packs/case	500*285*405	10.0
 AT200P-9-N-LB	200µl	Natural Low Retention	96 tips/rack, 10 racks/pack, 5 packs/case	500*285*405	10.0
AT200P-9-NS	200µl	Natural Pre-Sterilized	96 tips/rack, 10 racks/pack, 5 packs/case	500*285*405	10.0
 AT200P-9-NS-LB	200µl	Natural Low Retention Pre-Sterilized	96 tips/rack, 10 racks/pack, 5 packs/case	500*285*405	10.0
AF200P-9-NS	175µl	Natural Filtered, Pre-Sterilized	96 tips/rack, 10 racks/pack, 5 packs/case	500*285*405	10.0
 AF200P-9-NS-LB	175µl	Natural Low Retention Filtered, Pre-Sterilized	96 tips/rack, 10 racks/pack, 5 packs/case	500*285*405	10.0



ROBOTIC TIPS

Compatible with

PerkinElmer Janus , MultiProbe
 Multiprobe II HT/ET ,Sciclone ,Zephyr ,RapidPlate

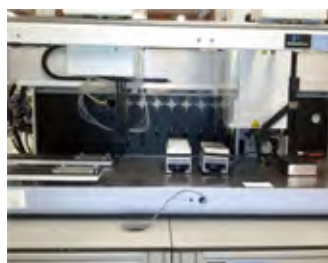

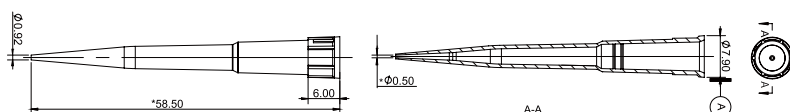
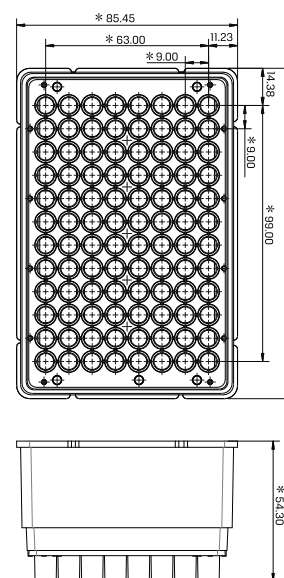

Format: 96-tip format
 Tip Volume range selection: 200µl
 Material: Conductive Polypropylene
 Alternatives:
 ○ With/without aerosol-barrier filter
 ○ Pre-Sterilized/Non-Sterilized
 ○ Low Retention/Standard
 Certified:
 DNase-Free, RNase-Free, Endotoxin-Safe

Material: Polypropylene



200µl

GEB Cat#	Max Volume	Type	Color	Packaging Specification	Carton Size L*W*H(mm)	Weight KGs
AT200P-9-X	200µl	Black	Black	96 tips/rack, 10 racks/pack, 5 packs/case	500*285*405	10.0
 AT200P-9-X-LB	200µl	Black Low Retention	Black	96 tips/rack, 10 racks/pack, 5 packs/case	500*285*405	10.0
AT200P-9-XS	200µl	Black Pre-Sterilized	Black	96 tips/rack, 10 racks/pack, 5 packs/case	500*285*405	10.0
 AT200P-9-XS-LB	200µl	Black Low Retention Pre-Sterilized	Black	96 tips/rack, 10 racks/pack, 5 packs/case	500*285*405	10.0
AF200P-9-XS	175µl	Black Filtered, Pre-Sterilized	Black	96 tips/rack, 10 racks/pack, 5 packs/case	500*285*405	10.0
 AF200P-9-XS-LB	175µl	Black Low Retention Filtered, Pre-Sterilized	Black	96 tips/rack, 10 racks/pack, 5 packs/case	500*285*405	10.0



ROBOTIC TIPS

Compatible with

PerkinElmer Janus , MultiProbe , Multiprobe II HT/ET

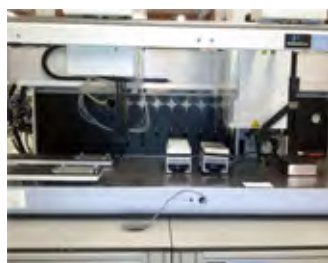

Format: 96-tip format
 Tip Volume range selection: 1000µl
 Material: Virgin Polypropylene
 Alternatives:
 ● With/without aerosol-barrier filter
 ● Pre-Sterilized/Non-Sterilized
 ● Low Retention/Standard
 Certified:
 DNase-Free, RNase-Free, Endotoxin-Safe

Material: Polypropylene

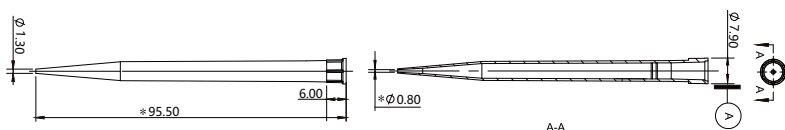
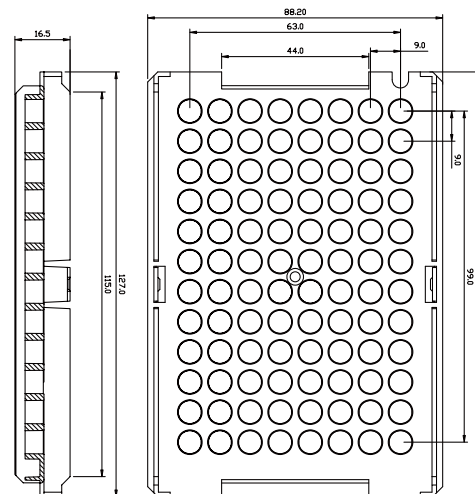

1000µl

	GEB Cat#	Max Volume	Type	Packaging Specification	Carton Size L*W*H(mm)	Weight KGs
	AT01MP-9-N	1000µl	Natural	96 tips/rack, 16 racks /case	405*285*235	3.65
	 AT01MP-9-N-LB	1000µl	Natural Low Retention	96 tips/rack, 16 racks /case	405*285*235	3.65
	AT01MP-9-NS	1000µl	Natural Pre-Sterilized	96 tips/rack, 16 racks /case	405*285*235	3.65
	 AT01MP-9-NS-LB	1000µl	Natural Low Retention Pre-Sterilized	96 tips/rack, 16 racks /case	405*285*235	3.65
	AF01MP-9-NS	1000µl	Natural Filtered, Pre-Sterilized	96 tips/rack, 16 racks /case	405*285*235	3.65
	 AF01MP-9-NS-LB	1000µl	Natural Low Retention Filtered, Pre-Sterilized	96 tips/rack, 16 racks /case	405*285*235	3.65

ROBOTIC TIPS

Compatible with

PerkinElmer Janus , MultiProbe , Multiprobe II HT/ET



Material: Polypropylene



Format: 96-tip format
 Tip Volume range selection: 1000µl
 Material: Conductive Polypropylene
 Alternatives:
 ● With/without aerosol-barrier filter
 ● Pre-Sterilized/Non-Sterilized
 ● Low Retention/Standard
 Certified:
 DNase-Free, RNase-Free, Endotoxin-Safe

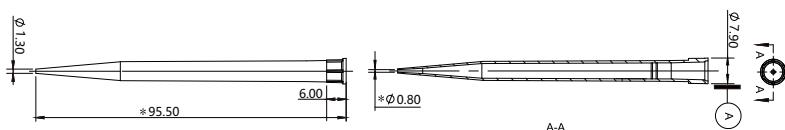
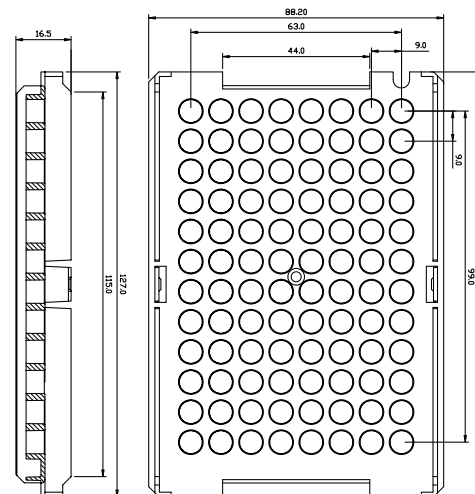

1000µl

	GEB Cat#	Max Volume	Type	Packaging Specification	Carton Size L*W*H(mm)	Weight KGs
	AT01MP-9-X	1000µl	Black	96 tips/rack, 16 racks /case	405*285*235	3.65
	 AT01MP-9-X-LB	1000µl	Black Low Retention	96 tips/rack, 16 racks /case	405*285*235	3.65
	AT01MP-9-XS	1000µl	Black Pre-Sterilized	96 tips/rack, 16 racks /case	405*285*235	3.65
	 AT01MP-9-XS-LB	1000µl	Black Low Retention Pre-Sterilized	96 tips/rack, 16 racks /case	405*285*235	3.65
	AF01MP-9-XS	1000µl	Black Filtered, Pre-Sterilized	96 tips/rack, 16 racks /case	405*285*235	3.65
	 AF01MP-9-XS-LB	1000µl	Black Low Retention Filtered, Pre-Sterilized	96 tips/rack, 16 racks /case	405*285*235	3.65

ROBOTIC TIPS

Compatible with
Olympus



Format: 140-tip format
 Tip Volume range selection: 1000µl
 Material: Virgin Polypropylene
 Alternatives:
 ○ With/without aerosol-barrier filter
 ○ Pre-Sterilized/Non-Sterilized
 ○ Low Retention/Standard
 Certified:
 DNase-Free, RNase-Free, Endotoxin-Safe

Material: Polypropylene

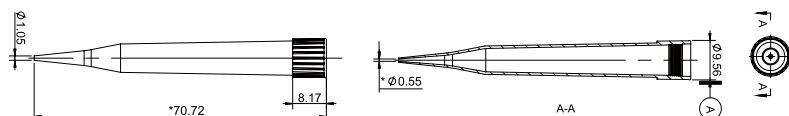
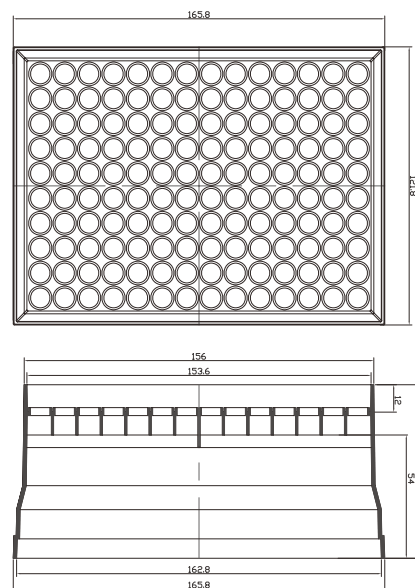

1000µl

	GEB Cat#	Max Volume	Type	Packaging Specification	Carton Size L*W*H(mm)	Weight KGs
	AT01M0-4-N	1000µl	Natural	140 tips/rack, 10 racks/pack, 4 packs/case	675*360*350	15.4
	 AT01M0-4-N-LB	1000µl	Natural Low Retention	140 tips/rack, 10 racks/pack, 4 packs/case	675*360*350	15.4
	AT01M0-4-NS	1000µl	Natural Pre-Sterilized	140 tips/rack, 10 racks/pack, 4 packs/case	675*360*350	15.4
	 AT01M0-4-NS-LB	1000µl	Natural Low Retention Pre-Sterilized	140 tips/rack, 10 racks/pack, 4 packs/case	675*360*350	15.4
	AF01M0-4-NS	1000µl	Natural Filtered, Pre-Sterilized	140 tips/rack, 10 racks/pack, 4 packs/case	675*360*350	15.4
	 AF01M0-4-NS-LB	1000µl	Natural Low Retention Filtered, Pre-Sterilized	140 tips/rack, 10 racks/pack, 4 packs/case	675*360*350	15.4

ROBOTIC TIPS

Compatible with
Olympus



Format: 140-tip format
 Tip Volume range selection: 1000µl
 Material: Conductive Polypropylene
 Alternatives:
 ○ With/without aerosol-barrier filter
 ○ Pre-Sterilized/Non-Sterilized
 ○ Low Retention/Standard
 Certified:
 DNase-Free, RNase-Free, Endotoxin-Safe

Material: Polypropylene

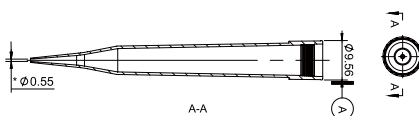
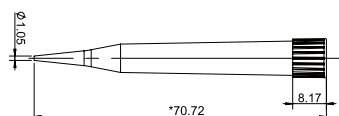
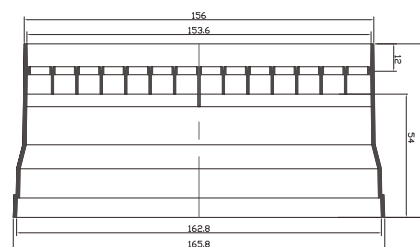
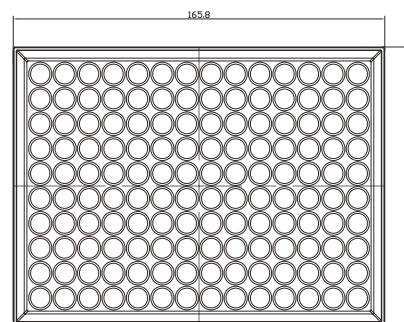

1000µl

	GEB Cat#	Max Volume	Type	Packaging Specification	Carton Size L*W*H(mm)	Weight KGs
	AT01M0-4-X	1000µl	Black	140 tips/rack, 10 racks/pack, 4 packs/case	675*360*350	15.4
	AT01M0-4-X-LB	1000µl	Black Low Retention	140 tips/rack, 10 racks/pack, 4 packs/case	675*360*350	15.4
	AT01M0-4-XS	1000µl	Black Pre-Sterilized	140 tips/rack, 10 racks/pack, 4 packs/case	675*360*350	15.4
	AT01M0-4-XS-LB	1000µl	Black Low Retention Pre-Sterilized	140 tips/rack, 10 racks/pack, 4 packs/case	675*360*350	15.4
	AF01M0-4-XS	1000µl	Black Filtered, Pre-Sterilized	140 tips/rack, 10 racks/pack, 4 packs/case	675*360*350	15.4
	AF01M0-4-XS-LB	1000µl	Black Low Retention Filtered, Pre-Sterilized	140 tips/rack, 10 racks/pack, 4 packs/case	675*360*350	15.4

ROBOTIC TIPS

Compatible with
Rainin



Format: 96-tip format
Tip Volume range selection: 800µl
Material: Conductive Polypropylene
Alternatives:

- With/without aerosol-barrier filter
- Pre-Sterilized/Non-Sterilized
- Low Retention/Standard

 Certified:
 DNase-Free, RNase-Free, Endotoxin-Safe

Material: Polypropylene

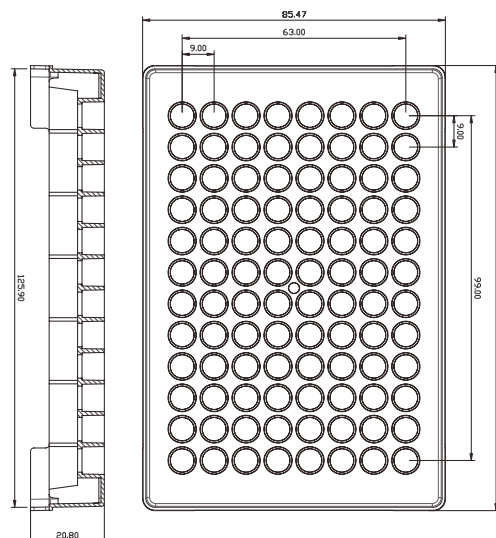
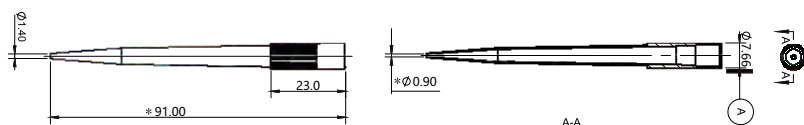

800µl

	GEB Cat#	Max Volume	Type	Packaging Specification	Carton Size L*W*H(mm)	Weight KGs
	AT800R-9-X	800µl	Black	96 tips/rack, 10 racks/pack, 5 packs/case	480*345*280	10.0
	 AT800R-9-X-LB	800µl	Black Low Retention	96 tips/rack, 10 racks/pack, 5 packs/case	480*345*280	10.0
	AT800R-9-XS	800µl	Black Pre-Sterilized	96 tips/rack, 10 racks/pack, 5 packs/case	480*345*280	10.0
 	AT800R-9-XS-LB	800µl	Black Low Retention Pre-Sterilized	96 tips/rack, 10 racks/pack, 5 packs/case	480*345*280	10.0
	 AF800R-9-XS	800µl	Black Filtered, Pre-Sterilized	96 tips/rack, 10 racks/pack, 5 packs/case	480*345*280	10.0
	 AF800R-9-XS-LB	800µl	Black Low Retention Filtered, Pre-Sterilized	96 tips/rack, 10 racks/pack, 5 packs/case	480*345*280	10.0

ROBOTIC TIPS

Compatible with

Zymark , Zymark Rapidplate , Sciclone
Fit Caliper , Tecan TEMO, Aquarius , GenMate



Format: 96-tip format
 Tip Volume range selection: 50µl
 Material: Virgin Polypropylene
 Alternatives:
 ● With/without aerosol-barrier filter
 ● Pre-Sterilized/Non-Sterilized
 ● Low Retention/Standard
 Certified:
 DNase-Free, RNase-Free, Endotoxin-Safe

Material: Polypropylene

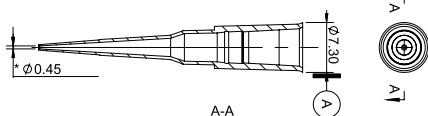
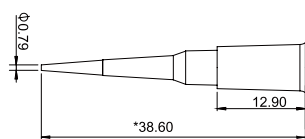
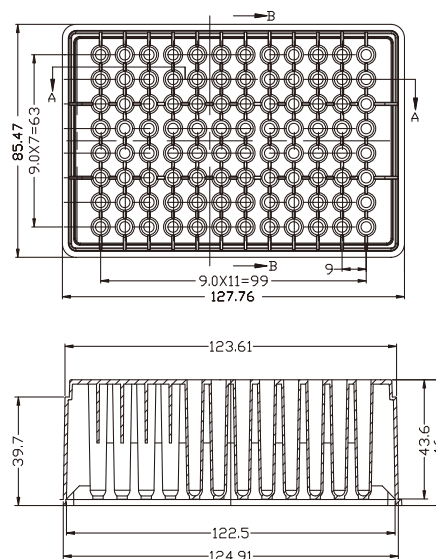

50µl

	GEB Cat#	Max Volume	Type	Packaging Specification	Carton Size L*W*H(mm)	Weight KGs
	AT050Z-9-N	50µl	Natural	96 tips/rack, 10 racks/pack, 5 packs/case	480*345*280	10.0
	AT050Z-9-N-LB	50µl	Natural Low Retention	96 tips/rack, 10 racks/pack, 5 packs/case	480*345*280	10.0
	AT050Z-9-NS	50µl	Natural Pre-Sterilized	96 tips/rack, 10 racks/pack, 5 packs/case	480*345*280	10.0
	AT050Z-9-NS-LB	50µl	Natural Pre-Sterilized, Low Retention	96 tips/rack, 10 racks/pack, 5 packs/case	480*345*280	10.0
	AF050Z-9-NS	50µl	Natural Filtered, Pre-Sterilized	96 tips/rack, 10 racks/pack, 5 packs/case	480*345*280	10.0
	AF050Z-9-NS-LB	50µl	Natural Low Retention Filtered, Pre-Sterilized	96 tips/rack, 10 racks/pack, 5 packs/case	480*345*280	10.0
	AT050Z-9N-NS	50µl	Natural Pre-Sterilized	96 tips/rack 8 racks/stack, 10 stacks/case	515*310*215	7.6
	AT050Z-9N-NS-LB	50µl	Natural Low Retention Filtered, Pre-Sterilized	96 tips/rack 8 racks/stack, 10 stacks/case	515*310*215	7.6

ROBOTIC TIPS

Compatible with

Zymark , Zymark Rapidplate , Sciclone
Fit Caliper , Tecan TEMO, Aquarius , GenMate



Format: 96-tip format
 Tip Volume range selection: 200µl
 Material: Virgin Polypropylene
 Alternatives:
 ● With/without aerosol-barrier filter
 ● Pre-Sterilized/Non-Sterilized
 ● Low Retention/Standard
 Certified:
 DNase-Free, RNase-Free, Endotoxin-Safe

Material: Polypropylene

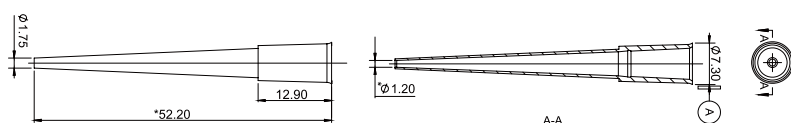
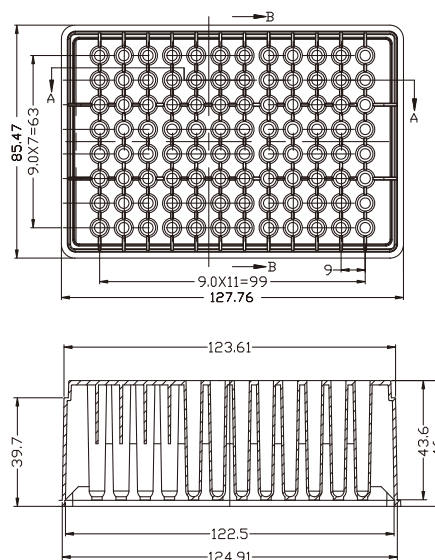

200µl

	GEB Cat#	Max Volume	Type	Packaging Specification	Carton Size L*W*H(mm)	Weight KGs
	AT200Z-9-N	200µl	Natural	96 tips/rack, 10 racks/pack, 5 packs/case	480*345*280	10.0
	AT200Z-9-N-LB	200µl	Natural Low Retention	96 tips/rack, 10 racks/pack, 5 packs/case	480*345*280	10.0
	AT200Z-9-NS	200µl	Natural Pre-Sterilized	96 tips/rack, 10 racks/pack, 5 packs/case	480*345*280	10.0
	AT200Z-9-NS-LB	200µl	Natural Pre-Sterilized, Low Retention	96 tips/rack, 10 racks/pack, 5 packs/case	480*345*280	10.0
	AF2000Z-9-NS	180µl	Natural Filtered, Pre-Sterilized	96 tips/rack, 10 racks/pack, 5 packs/case	480*345*280	10.0
	AF200Z-9-NS-LB	180µl	Natural Low Retention Filtered, Pre-Sterilized	96 tips/rack, 10 racks/pack, 5 packs/case	480*345*280	10.0
	AT200Z-9N-NS	200µl	Natural Pre-Sterilized	96 tips/rack 8 racks/stack, 10 stacks/case	515*310*215	7.6
	AT200Z-9N-NS-LB	200µl	Natural Low Retention Filtered, Pre-Sterilized	96 tips/rack 8 racks/stack, 10 stacks/case	515*310*215	7.6

ROBOTIC TIPS

Compatible with

Cybi , CyBi -Well Family, Cybi -Well, Cybi -Well Vario, Cybi -WellFlex, Cybi -WellFlex Vario



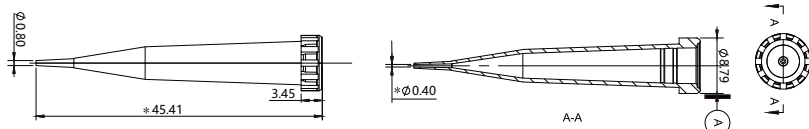
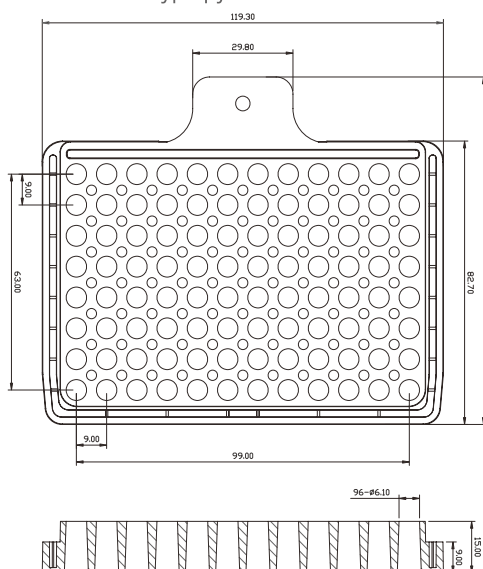

Format: 96-tip format
 Tip Volume range selection: 50µl
 Material: Virgin Polypropylene
 Alternatives:
 ○ With/without aerosol-barrier filter
 ○ Pre-Sterilized/Non-Sterilized
 ○ Low Retention/Standard
 Certified:
 DNase-Free, RNase-Free, Endotoxin-Safe

Material: Polypropylene



50µl

GEB Cat#	Max Volume	Type	Packaging Specification	Carton Size L*W*H(mm)	Weight KGs
AT050CY-9-N	50µl	Natural	96 tips/rack, 8 racks/pack, 5 packs/case	500*285*405	10.0
 AT050CY-9-N-LB	50µl	Natural Low Retention	96 tips/rack, 8 racks/pack, 5 packs/case	500*285*405	10.0
AT050CY-9-NS	50µl	Natural Pre-Sterilized	96 tips/rack, 8 racks/pack, 5 packs/case	500*285*405	10.0
 AT050CY-9-NS-LB	50µl	Natural Low Retention Pre-Sterilized	96 tips/rack, 8 racks/pack, 5 packs/case	500*285*405	10.0
AF050CY-9-NS	50µl	Natural Filtered, Pre-Sterilized	96 tips/rack, 8 racks/pack, 5 packs/case	500*285*405	10.0
 AF050CY-9-NS-LB	50µl	Natural Low Retention Filtered, Pre-Sterilized	96 tips/rack, 8 racks/pack, 5 packs/case	500*285*405	10.0



ROBOTIC TIPS

Compatible with

Cybi , CyBi -Well Family, Cybi -Well, Cybi -Well Vario, Cybi -WellFlex, Cybi -WellFlex Vario



Format: 96-tip format
 Tip Volume range selection: 250µl
 Material: Virgin Polypropylene
 Alternatives:
 ● With/without aerosol-barrier filter
 ● Pre-Sterilized/Non-Sterilized
 ● Low Retention/Standard
 Certified:
 DNase-Free, RNase-Free, Endotoxin-Safe

Material: Polypropylene

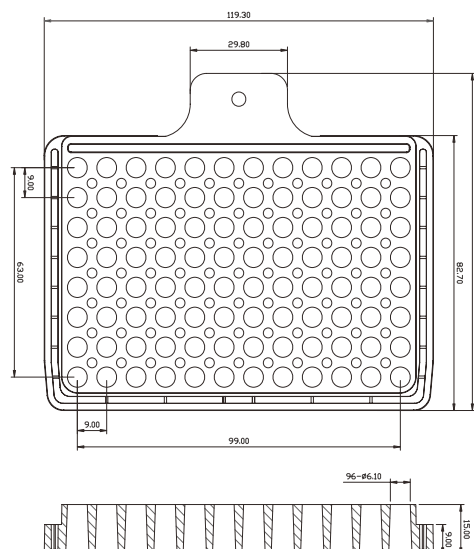
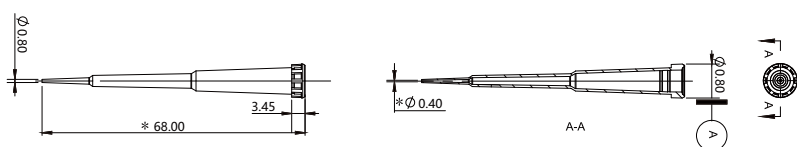

250µl

	GEB Cat#	Max Volume	Type	Packaging Specification	Carton Size L*W*H(mm)	Weight KGs
	AT250CY-9-N	250µl	Natural	96 tips/rack, 8 racks/pack, 5 packs/case	500*285*405	10.0
	 AT250CY-9-N-LB	250µl	Natural Low Retention	96 tips/rack, 8 racks/pack, 5 packs/case	500*285*405	10.0
	AT250CY-9-NS	250µl	Natural Pre-Sterilized	96 tips/rack, 8 racks/pack, 5 packs/case	500*285*405	10.0
	 AT250CY-9-NS-LB	250µl	Natural Low Retention Pre-Sterilized	96 tips/rack, 8 racks/pack, 5 packs/case	500*285*405	10.0
	 AF250CY-9-NS	250µl	Natural Filtered, Pre-Sterilized	96 tips/rack, 8 racks/pack, 5 packs/case	500*285*405	10.0
	 AF250CY-9-NS-LB	250µl	Natural Low Retention Filtered, Pre-Sterilized	96 tips/rack, 8 racks/pack, 5 packs/case	500*285*405	10.0

ROBOTIC TIPS

Compatible with
Dynex ,DSX/DS2



Format:108-tip format
 Tip Volume range selection:350µl
 Material: Virgin Polypropylene
 Alternatives: Pre-Sterilized/Non-Sterilized
 Certified:
 DNase-Free, RNase-Free, Endotoxin-Safe

Material: Polypropylene

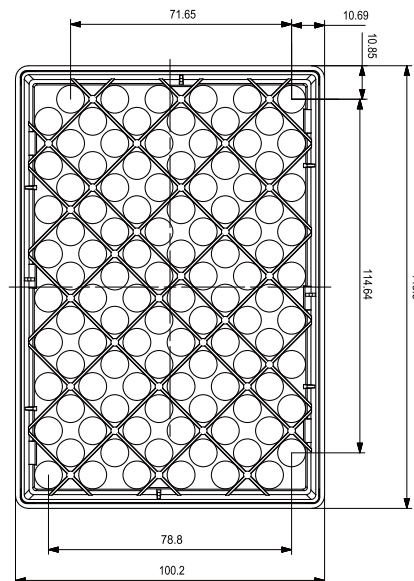
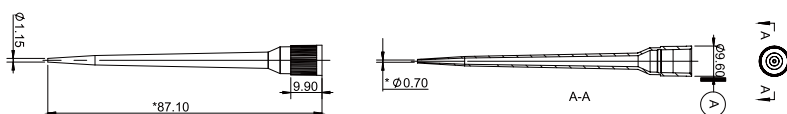

350µl

	GEB Cat#	Max Volume	Type	Packaging Specification
	AT350D-108-B	350µl	Blue	108 tips/rack, 10 racks/pack, 5 packs/case
	AT350D-108-BS	350µl	Blue Pre-Sterilized	108 tips/rack, 10 racks/pack, 5 packs/case

ROBOTIC TIPS

Compatible with
HITACHI

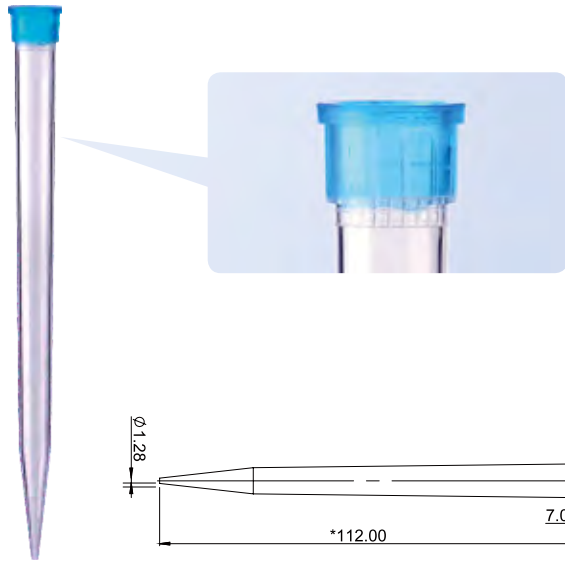

Innovative Robotic Tips

- ⊙ Virgin PP/TPU Dual Resin Molding
- ⊙ Super elasticity , Optimum Leakproofness
- ⊙ Reduce Robotic Head operating force
- ⊙ Prolong Robotic Head life cycle

2500µl

GEB Cat#	Max Volume	Tip Color	Packaging Specification	Carton Size L*W*H(mm)	Weight KGs
AT02MHT-B-B	2500µl	Natural	500 tips/bag, 10 bags/case	595*325*310	10.6

ROBOTIC TIPS

Compatible with
FuJi



Tip Volume range selection: 100µl
 Material: Virgin Polypropylene
 Alternatives: ⊙ with/without aerosol-barrier filter
 ⊙ Pre-Sterilized/Non-Sterilized
 ⊙ Low Retention/Standard
 Certified: DNase-Free, RNase-free, Endotoxin-Safe

100µl

GEB Cat#	Max Volume	Tip Color	Packaging Specification
 AT100F-B-N-LB	100µl	Natural	1000 tips/bag, 10 bags/case

ROBOTIC TIPS
Compatible with
Biotix



Material: Polypropylene

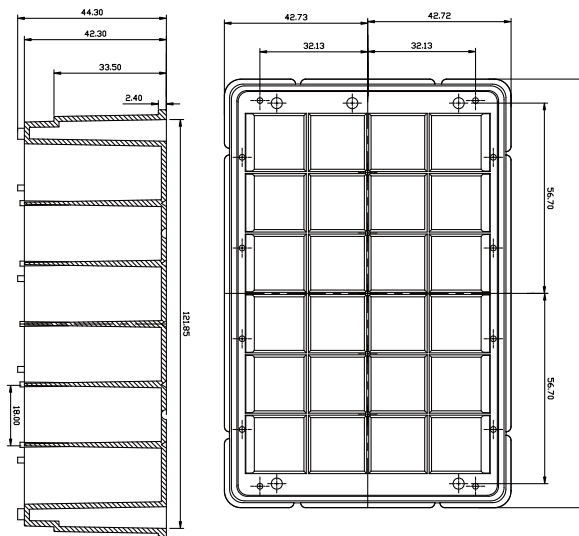

Format: 96-tip format
Tip Volume range selection: 300µl
Material: Virgin Polypropylene
Alternatives:

- With/without aerosol-barrier filter
- Pre-Sterilized/Non-Sterilized
- Low Retention/Standard

 Certified:
DNase-Free, RNase-Free, Endotoxin-Safe

Biotix 300µl



GEB Cat#	Max Volume	Type	Packaging Specification
AT300BT-B-N-LB	300µl	Natural Low Retention	1000 tips/bag,20 bags/case
AT300BT-9-N	300µl	Natural	96 tips/rack10 racks/pack,5 packs/case
 AT300BT-9-N-LB	300µl	Natural Low Retention	96 tips/rack10 racks/pack,5 packs/case

PCR Series

Optimum Accuracy and Reliability

Solution for Accuracy and Reliability of PCR Results

Gene Diagnosis • Drug Discovery • Genomic Research

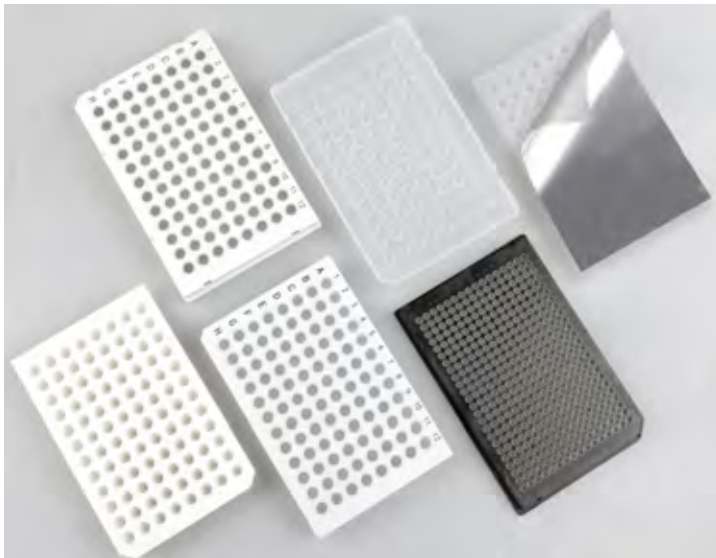

GEB Exclusive DRM Dual Resin PCR series

DUAL RESIN PCR products provide greater ease of closure and increased seal integrity; "ZERO" evaporation and reduced "edge-effect" prevent aerosol contaminants and subsequent false positive PCR results.



GEB R&R Low Retention PCR series

GEB's **R&R** Low Retention PCR Tubes/Plate provide you a super uniformity and consistent retentionless surface to create a **RETENTIONLESS RECOVERY** effect during your samples and reagents handling.

GEB keeps researching and developing technique for less sample retention and less electrostatic violence and better leakproofness so as to guarantee the PCR result accurate.



Minimize sample and reagent retention
Guarantee reaction system accuracy and precision



Provide a better seal effect
Be more flexible to fit robotic pipetting head or manual pipettors

PCR SERIES

Single PCR tube, 8 Strip tubes and PCR Plate

Caps and Closures

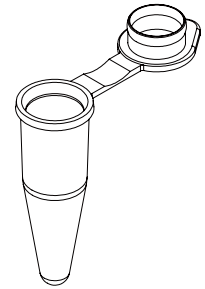
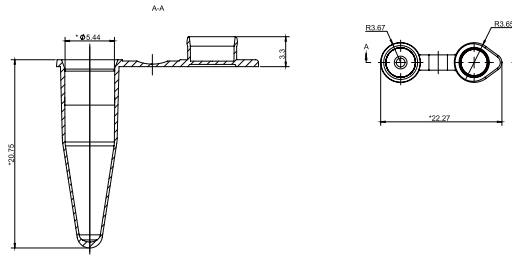

0.2ml-flat cap



GEB Cat#	Volume	Color	Type	Packaging Specification	Carton Size L*W*H(mm)	Weight KGs
PC0201-B-N	0.2ml	Natural	Thin Wall, Flat Cap	500 tubes per bag, 2bags per pack,10packs per case	515*310*215	3.04
PC0201-B-N-RT	0.2ml	Natural	Real Time, Thin Wall, Flat Cap	500 tubes per bag, 2bags per pack,10packs per case	515*310*215	3.04

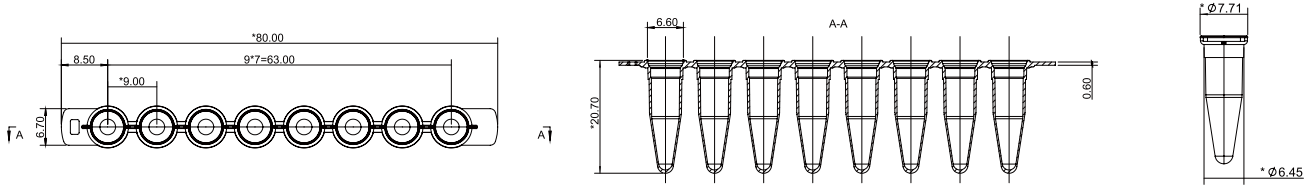

0.2ml 8-strip PCR tubes, without caps



GEB Cat#	Volume	Color	Tip Color	Packaging Specification	Carton Size L*W*H(mm)	Weight KGs
PCA0208-B-N	0.2ml	Natural	Thin Wall, 8 strip without Cap	8 tubes per strip, 125 strips per bag,10 bags per case	515*310*215	2.66



PC0208-B-N	0.2ml	Natural	Thin Wall, 8 strip without Cap	8 tubes per strip, 125 strips per bag,10 bags per case	515*310*215	2.66
------------	-------	---------	--------------------------------	---	-------------	------

0.2ml 8-Strip Flat Caps



GEB Cat#	Compatibility	Packaging Specification
PC0028-B-N	fit 0.2ml 8-Strip PCR tubes(GEB Cat# PC0208-B-N, PC10FS-9-N, PC10HS-9-W-LC)	8 caps per strip, 125 strips per bag, 10 bags per case

0.2ml 8-strip PCR tubes bracket



GEB Cat#	Color	Tip Color	Packaging Specification	Carton Size L*W*H(mm)	Weight KGs
PCS08-B-N	Natural	8-strip bracket	8 tubes per strip, 125 strips per bag,10 bags per case	515*310*215	1.93

0.2ml 8-strip PCR tubes stack box

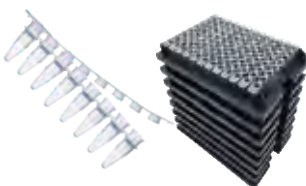

GEB Cat#	Volume	Color	Packaging Specification	Pack Size L*W*H(mm)
PC0208-E-N	0.2ml	Natural	12 tubes per rack, 6 racks per pack,10 packs per case	140*90*120

PCR SERIES

Single PCR tube, 8 Strip tubes and PCR Plate

Caps and Closures



Dual Resin 4-strip PCR tubes, without caps



GEB Cat#	Volume	Color	Packaging Specification
PC0504-B-TS	50ul	Natural	4 tubes per strip, 500 strips per bag,10packs per case

Dual Resin 4-strip PCR tubes, with caps



GEB Cat#	Volume	Color	Type	Packaging Specification
PC004-B-TS	50ul	Natural	Dual Resin	4 tubes per strip, 500 strips per bag,10packs per case

Dual Resin 4-strip PCR tubes, with caps

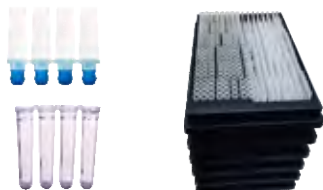

GEB Cat#	Volume	Color	Packaging Specification	Carton Size L*W*H(mm)
PC0504-E-TS	50µl	Natural	48 strips per plate, 6 plates per bag,10 packs per case	140*90*120

0.1ml Dual Resin 8-strip PCR tubes, without caps



GEB Cat#	Volume	Color	Type	Packaging Specification
PC0108-B-TS	0.1ml	Natural	Dual Resin	8 tubes per strip, 125 strips per bag,10 bags per case

0.1ml Dual Resin 8-strip PCR tubes, without caps

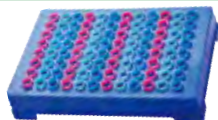

GEB Cat#	Volume	Color	Type	Packaging Specification
PC0108-9-TS	0.1ml	Natural	Dual Resin	12 strips per plate, 10plates per pack,10 packs per case

0.2ml Dual Resin 8-strip PCR tubes, without caps

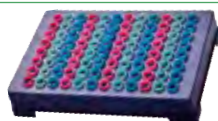

GEB Cat#	Volume	Color	Type	Packaging Specification
PC0208-9-TS	0.2ml	Natural	Dual Resin	12 strips per plate, 10plates per pack,10 packs per case

PCR SERIES PCR Plate



0.2ml 96-well PCR Plate PP

GEB Cat#	Max Volume	Color	Type	Packaging Specification	Carton Size L*W*H(mm)	Weight KGs
PC20HS-9-N	0.2ml	Natural	Half Skirt	10 plates per bag , 5 bags per case	465*155*140	5.0

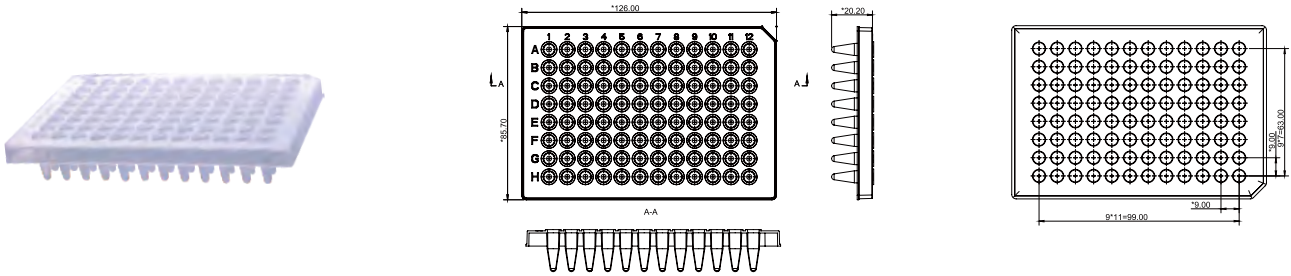

PC20NS-9-N	0.2ml	Natural	No Skirt	10 plates per bag , 5 bags per case	465*155*140	5.0
------------	-------	---------	----------	-------------------------------------	-------------	-----

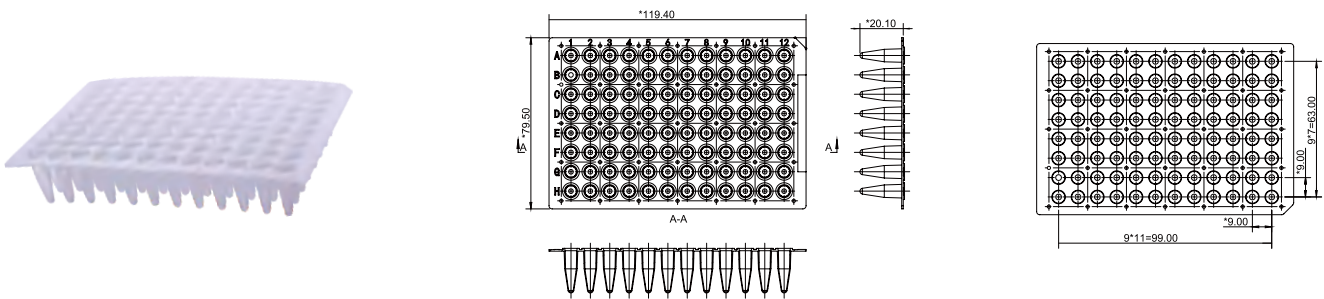

PCR SERIES PCR Plate



0.1ml 96-Well PCR Plate, PP

GEB Cat#	Max Volume	Color	Type	Packaging Specification	Carton Size L*W*H(mm)	Weight KGs
PC10FS-9-N	0.1ml	Natural	Full Skirt	10 plates per bag , 5 bags per case	465*155*140	5.0

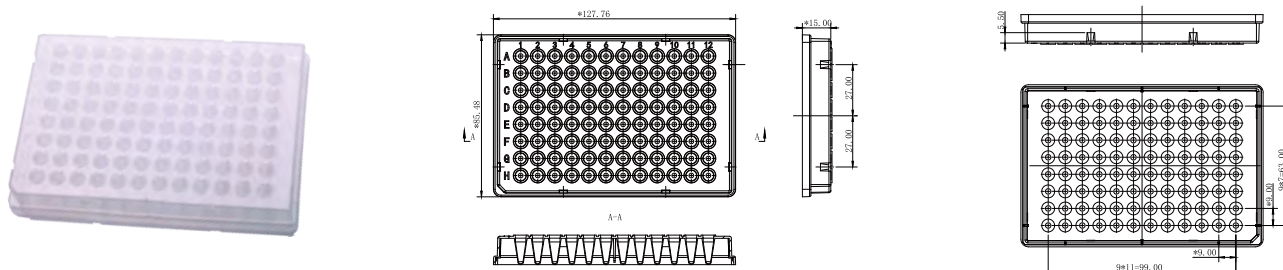

PC10HS-9-W-LC	0.1ml	White	Half Skirt Fit Roche Light Cycler	10 plates per bag , 5 bags per case	465*155*140	5.0
---------------	-------	-------	--------------------------------------	-------------------------------------	-------------	-----

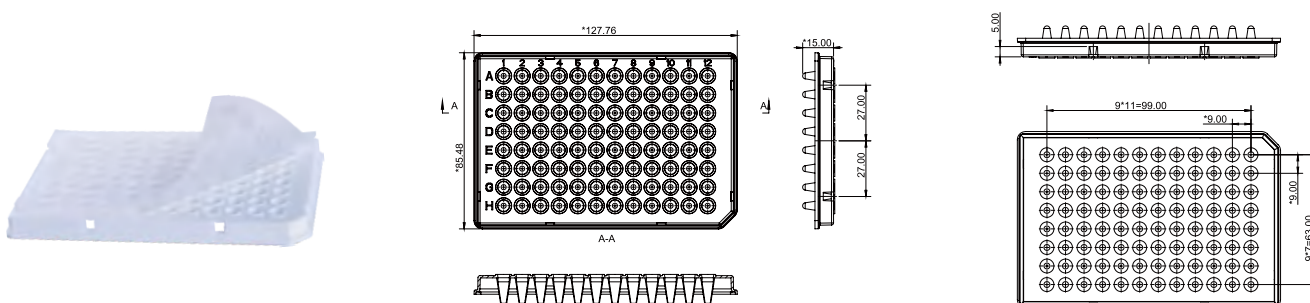

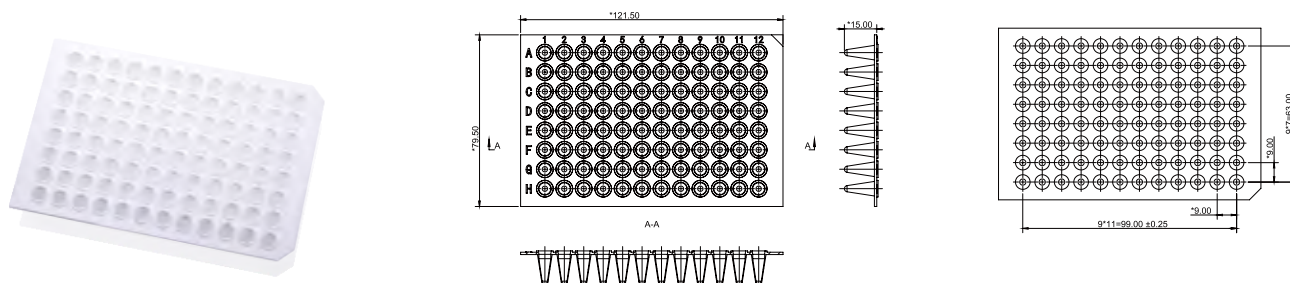

PC10NS-9-W	0.1ml	White	No Skirt	10 plates per bag , 5 bags per case	465*155*140	5.0
------------	-------	-------	----------	-------------------------------------	-------------	-----



PCR SERIES PCR Plate



40µl 384-Well PCR Plate, PP

	GEB Cat#	Max Volume	Color	Type	Packaging Specification	Carton Size L*W*H(mm)	Weight KGs
	PC04FS-3-N	40µl	Natural	Full Skirt	10 plates per bag , 5 bags per case Fit Roche Light Cycler	465*155*140	3.5
	PC04FS-3-X-RC	40µl	Black	Full Skirt	10 plates per bag , 5 bags per case Fit Roche Light Cycler	465*155*140	3.5

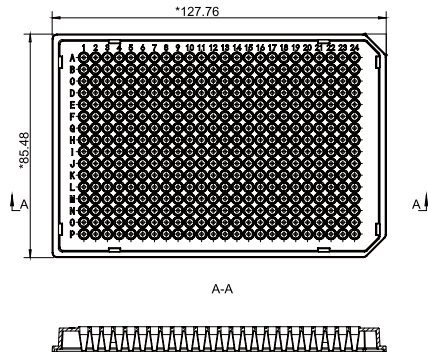

PC04FS-3-N

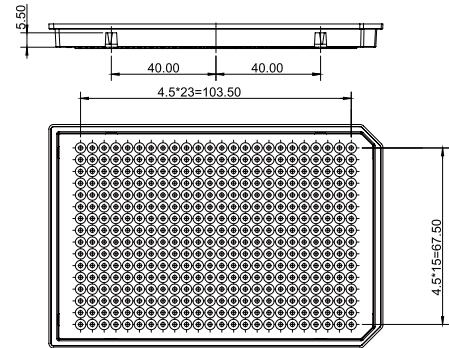

PCR SERIES PCR Plate



0.1ml 96-Well PCR Plate, fit ABI

GEB Cat#	Max Volume	Color	Type	Packaging Specification	Carton Size L*W*H(mm)	Weight KGs
PC10HS-9-LP-N-AB	0.1ml	Natural	Low Profile	10 plates per bag , 5 bags per case	465*155*140	5.0

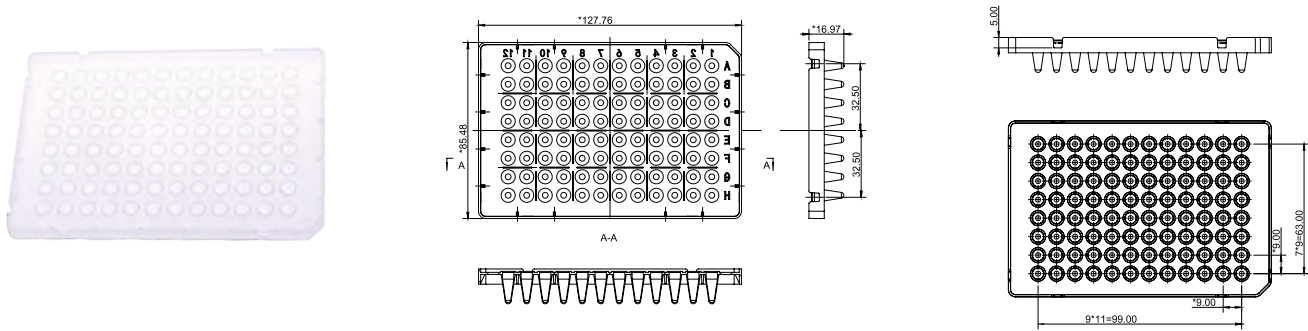

0.2ml 96-Well PCR Plate, fit ABI

GEB Cat#	Max Volume	Color	Type	Packaging Specification	Carton Size L*W*H(mm)	Weight KGs
PC20ES-9-N-AB	0.2ml	Natural	Elevated Skirt	10 plates per bag , 5 bags per case	465*155*140	5.0

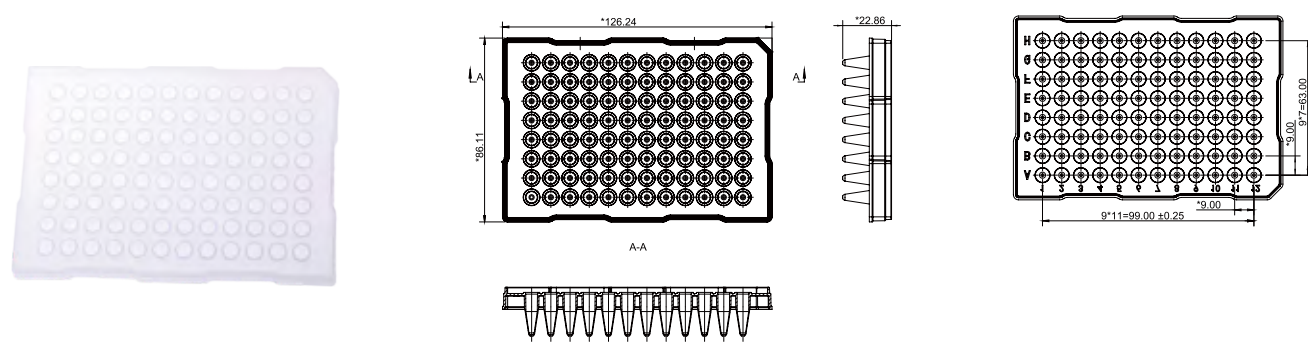

PCR SERIES

Dual color PCR Plate



0.1ml 96-Well PCR Plate

GEB Cat#	Max Volume	Type	Packaging Specification
PC10FS-9-TS-W	100 μ l	Full skirt, dual-color, white	10 plates per bag , 5 bags per case

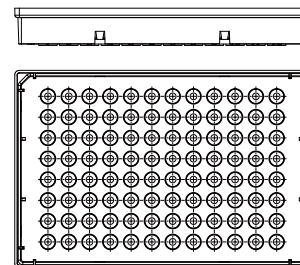
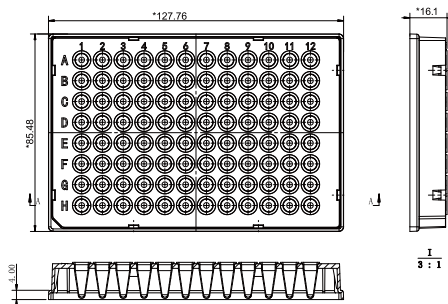

0.1ml 96-Well PCR Plate





GEB Cat#	Max Volume	Type	Packaging Specification
PC10NS-9Z-TS-W	100 μ l	No skirt, dual-color Breakable	10 plates per bag , 5 bags per case



PCR SERIES Sealing film

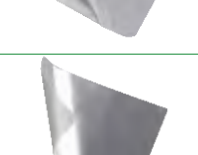

Film for PCR Plate

	GEB Cat#	Compatibility	Packaging Specification	Carton Size L*W*H(mm)	Weight KGs
	PCOMAT-9-N	Fit 96/384-well plate	10 pcs per bag , 5 bags per case	140*40*160	1.32
	RT-PCOMAT-N3	Fit 96/384-well plate	10 pcs per bag , 5 bags per case	140*40*160	1.32
	RT-PCOMAT-N4	Puncturable heat sealing film	10 pcs per bag , 5 bags per case	140*40*160	1.32
	ALF-9-S-EP	Puncturable heat sealing film Fit 96/384-well plate	10 pcs per bag , 5 bags per case	140*40*160	1.32
	ALF-9-S-EP2	Puncturable heat sealing film Fit 96/384-well plate	10 pcs per bag , 5 bags per case	140*40*160	1.32
	ALF-9-GS	Aluminum foil heat sealing film Fit 96-well plate	10 pcs per bag , 5 bags per case	140*40*160	1.32

GEB, Your Better Choice

PCR Plate Compatibility

BRAND	MODEL	PCR20NS-9-N	PC20HS-9-X/W-RID	PC04FS-3-W/X-RID	PC20HS-9-N	PC10FS-9-N	PC10HS-9-W-LC	PC10NS-9-W
PCR Instrument								
Applied Biosystems	Veriti	✓	✓		✓			
	9600	✓	✓		✓			
	9700	✓	✓		✓			
	2702	✓	✓	✓	✓			
	9800 FAST	✓	✓		✓			
Biometra	Uno	✓	✓		✓	✓		✓
	Uno II	✓	✓	✓	✓			✓
	T1 Thermal Cycler	✓	✓	✓	✓	✓		✓
	Tgradient	✓	✓		✓	✓		✓
	Trobot	✓	✓	✓	✓	✓		✓
BioRad	iCycler	✓	✓		✓			
	MyCycler	✓	✓		✓			
Corbett Research	PalmCycler 96		✓		✓	✓		✓
	PalmXycler 384			✓				
Eppendorf	MasterCycler	✓	✓		✓	✓		✓
	MasterCycler ep	✓	✓		✓	✓		✓
	MasterCycler 384			✓				
Flexi	Gene	✓	✓	✓	✓	✓		
	Genius	✓	✓		✓	✓		
Ericom	Single Block	✓	✓		✓			✓
	Twin Block	✓	✓		✓			✓
	Deltacycler 1	✓	✓		✓			✓

PCR Plate Compatibility

BRAND	MODEL	PCR20NS-9-N	PC20HS-9-X/W-RID	PC04FS-3-W/X-RID	PC20HS-9-N	PC10FS-9-N	PC10HS-9-W-LC	PC10NS-9-W
PCR Instrument								
ThermoHybaid	PCR Spirit		✓		✓	✓		
	PCR Express	✓	✓	✓	✓	✓		✓
	Multiblock System	✓	✓	✓	✓	✓		✓
	Touchdown	✓	✓	✓	✓	✓		✓
	Omnigene	✓	✓	✓	✓	✓		✓
	Omn-E	✓	✓		✓	✓		✓
	pxe	✓	✓	✓	✓	✓		✓
	pe2	✓	✓	✓	✓	✓		✓
MJ Research	PTC-100	✓	✓	✓	✓	✓		✓
	PTC-200	✓	✓	✓	✓	✓		✓
	PTC-225 Tetrad	✓	✓	✓	✓	✓		✓
	Dyad/Disciple	✓	✓	✓	✓	✓		✓
MWG	Primus 96	✓	✓		✓	✓		✓
	Primus 384			✓				
Stratagene	Robocycler	✓				✓		
TakaRa	TP240					✓		
	Tp3000	✓	✓		✓	✓		✓
Tachne	Touchgene Gradient (Tc512)	✓	✓	✓	✓	✓		✓
	Genius(TC412)	✓		✓	✓	✓		✓
	TouchgeneX	✓	✓	✓	✓	✓		✓

GEB, Your Better Choice

PCR Plate Compatibility

BRAND	MODEL	PCR20NS-9-N	PC20HS-9-X/W-RID	PC04FS-3-W/X-RID	PC20HS-9-N	PC10FS-9-N	PC10HS-9-W-LC	PC10NS-9-W
PCR Instrument								
Applied Biosystems	7000	✓	✓		✓			
	7300	✓	✓		✓			
	7500	✓	✓		✓			
	7700	✓	✓		✓			
	7900HT		✓	✓	✓			
	StepOne							
BioRad	iCycler	✓	✓		✓			
	MyiQ	✓	✓		✓	✓		
	iQ5	✓						
Stratagene	MX-3000	✓						
	MX-4000							
Eppendorf	MasterCycler ep						✓	✓
	Realplex							
MJ Research	Opticon					✓	✓	✓
	Opticon2					✓	✓	✓
	Opromo4					✓	✓	✓
Techne	Quantica					✓	✓	✓
Roche	lightCycler 4800						✓	
Sequencer								
Applied Biosystems	3100	✓	✓	✓	✓			
	3130	✓	✓	✓	✓			
	3700	✓	✓	✓	✓			
	3730/3730x	✓	✓	✓	✓			
Amershams	MegaBACE500					✓		
	MegaBACE1000							
	MegaBACE4000			✓				
Beckman	CEQ							
MJ Research	BaseStation					✓		
Transgenomic	WAVE System					✓		

GEB, Your Better Choice

Universal Fit Pipette Tips

Better Tips for Improved Flexibility

Our innovation guarantees your pipetting with improved accuracy and flexibility



GEB TWC THIN WALL CROWN

Pipette tips provide you a better seal effect for pipettors, and are more flexible and require less insertion force.

GEB produces pipette tips with exclusive techniques of TWC Thin Wall Crown and R&R Low Retention so that the cooperation between pipettor and tip is optimized.

The liquid handling will be more accurate and flexible with GEB pipette tips.



Minimize sample and reagent retention
Guarantee reaction system accuracy and precision





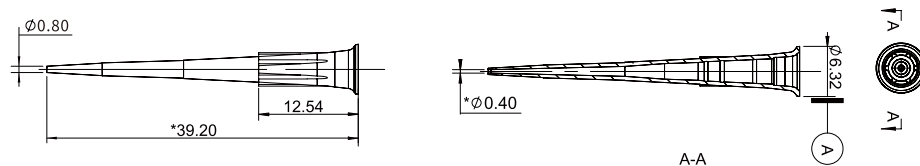

®-Holder Low Retention Technique

Pipette Tips without Aerosol Barrier

Tips Compatible for a wide range of pipettors
Universal Fit







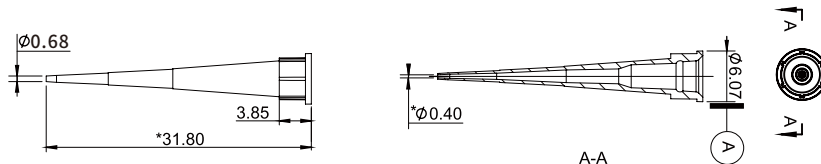

10µl with graduation marks at 2µl and 10µl (Extended length tip allows easy access to narrow, deep wells)

GEB Cat#	Volume	Type	Packaging Specification	Carton Size L*W*H(mm)	Weight KGs
 PTS0010-B-N	0.5-10 µl	Natural	1000 tips / bag , 20 bags / case	455*265*255	7.6
 PTS0010-B-N-LB	0.5-10 µl	Natural Low Retention	1000 tips / bag , 20 bags / case	455*265*255	7.6
PTS0010-9-N	0.5-10 µl	Natural	96 tips / rack 10racks / pack, 5 packs / case	480*345*280	8.2
 PTS0010-9-N-LB	0.5-10 µl	Natural Low Retention	96 tips / rack 10racks / pack, 5 packs / case	480*345*280	8.2
PTS0010-9-NS	0.5-10 µl	Natural Pre-Sterilized	96 tips / rack 10racks / pack, 5 packs / case	480*345*280	8.2
 PTS0010-9-NS-LB	0.5-10 µl	Natural Low Retention , Pre-Sterilized	96 tips / rack 10racks / pack, 5 packs / case	480*345*280	8.2
 PTS0010-E-N	0.5-10 µl	Natural	96 tips / rack 10racks / pack, 10 packs / case	455*265*255	7.1
 PTS0010-E-N-LB	0.5-10 µl	Natural Low Retention	96 tips / rack 10racks / pack, 10 packs / case	455*265*255	7.1



10µl with graduation marks at 2µl and 10µl







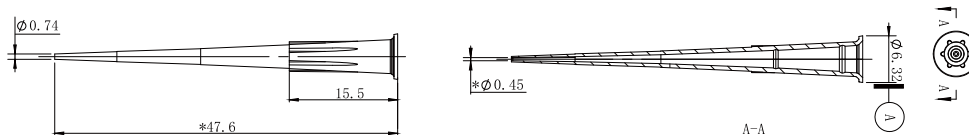

GEB Cat#	Volume	Type	Packaging Specification	Carton Size L*W*H(mm)	Weight KGs
 PTS0010-B-N	0.5-10 µl	Natural	1000 tips / bag , 20 bags / case	455*265*255	7.6
 PTS0010-B-N-LB	0.5-10 µl	Natural Low Retention	1000 tips / bag , 20 bags / case	455*265*255	7.6
PTS0010-9-N	0.5-10 µl	Natural	96 tips / rack 10racks / pack, 5 packs / case	480*345*280	7.6
 PTS0010-9-N-LB	0.5-10 µl	Natural Low Retention	96 tips / rack 10racks / pack, 5 packs / case	480*345*280	7.6
PTS0010-9-NS	0.5-10 µl	Natural Pre-Sterilized	96 tips / rack 10racks / pack, 5 packs / case	480*345*280	7.6
 PTS0010-9-NS-LB	0.5-10 µl	Natural Low Retention , Pre-Sterilized	96 tips / rack 10racks / pack, 5 packs / case	480*345*280	7.6
 PTS0010-E-N	0.5-10 µl	Natural	96 tips / rack 10racks / pack, 10 packs / case	455*265*255	7.1
 PTS0010-E-N-LB	0.5-10 µl	Natural Low Retention	96 tips / rack 10racks / pack, 10 packs / case	455*265*255	7.1

Pipette Tips without Aerosol Barrier

Tips Compatible for a wide range of pipettors
Universal Fit



10µl long Version with graduation marks at 2µl and 10µl

GEB Cat#	Volume	Type	Packaging Specification	Carton Size L*W*H(mm)	Weight KGs
 PTL0010-B-N	0.5-10 µl	Natural	1000 tips / bag , 20 bags / case	455*265*255	8.5
 PTL0010-B-N-LB	0.5-10 µl	Natural Low Retention	1000 tips / bag , 20 bags / case	455*265*255	8.5
 PTL0010-9-N	0.5-10 µl	Natural	96 tips / rack 10racks / pack, 5 packs / case	480*345*280	7.5
 PTL0010-9-N-LB	0.5-10 µl	Natural Low Retention	96 tips / rack 10racks / pack, 5 packs / case	480*345*280	7.5
 PTL0010-9-NS	0.5-10 µl	Natural Pre-Sterilized	96 tips / rack 10racks / pack, 5 packs / case	480*345*280	7.5
 PTL0010-9-NS-LB	0.5-10 µl	Natural Low Retention, Pre-Sterilized	96 tips / rack 10racks / pack, 5 packs / case	480*345*280	7.5
 PTL0010-E2-N	0.5-10 µl	Natural	96 tips / rack 10racks / pack, 10 packs / case	455*265*255	8.5
 PTL0010-E2-N-LB	0.5-10 µl	Natural Low Retention	96 tips / rack 10racks / pack, 10 packs / case	455*265*255	8.5

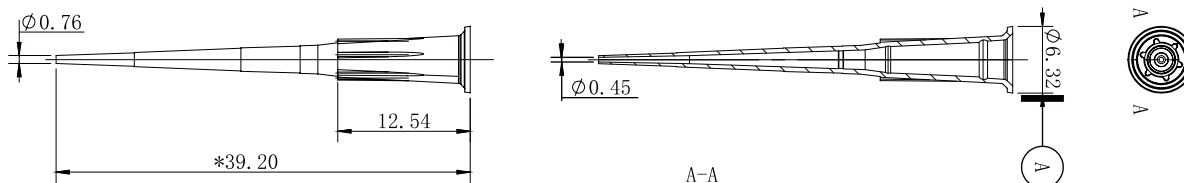

10µl fine with graduation marks at 2µl and 10µl



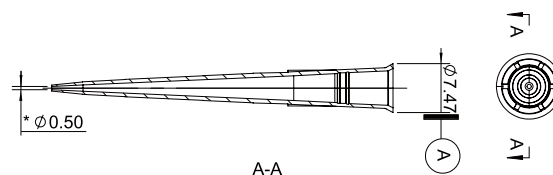
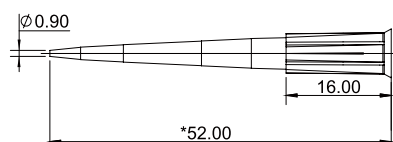

GEB Cat#	Volume	Type	Packaging Specification	Carton Size L*W*H(mm)	Weight KGs
 PTF0010-B-N	0.5-10 µl	Natural	1000 tips / bag , 20 bags / case	455*265*255	7.6
 PTF0010-B-N-LB	0.5-10 µl	Natural Low Retention	1000 tips / bag , 20 bags / case	455*265*255	7.6
 PTF0010-9-N	0.5-10 µl	Natural	96 tips / rack 10racks / pack, 5 packs / case	480*345*280	7.6
 PTS0010-9-N-LB	0.5-10 µl	Natural Low Retention	96 tips / rack 10racks / pack, 5 packs / case	480*345*280	7.6
 PTF0010-9-NS	0.5-10 µl	Natural Pre-Sterilized	96 tips / rack 10racks / pack, 5 packs / case	480*345*280	7.6
 PTF0010-9-NS-LB	0.5-10 µl	Natural Low Retention, Pre-Sterilized	96 tips / rack 10racks / pack, 5 packs / case	480*345*280	7.6
 PTF0010-E2-N	0.5-10 µl	Natural	96 tips / rack 10racks / pack, 10 packs / case	455*265*255	7.1
 PTF0010-E2-N-LB	0.5-10 µl	Natural Low Retention	96 tips / rack 10racks / pack, 10 packs / case	455*265*255	7.1

Pipette Tips without Aerosol Barrier

Tips Compatible for a wide range of pipettors
Universal Fit



200µl with graduation marks at 10µl, 50µl and 100µl

GEB Cat#	Volume	Type	Packaging Specification	Carton Size L*W*H(mm)	Weight KGs
PT0200-B-Y	10-200µl	Yellow	1000 tips / bag , 20 bags / case	595*325*310	6.9
 PT0200-B-Y-LB	10-200µl	Yellow Low Retention	1000 tips / bag , 20 bags / case	595*325*310	6.9
PT0200-9-Y	10-200µl	Yellow	96 tips / rack 10 racks / pack, 5 packs / case	500*450*265	8.8
 PT0200-9-Y-LB	10-200µl	Yellow Low Retention	96 tips / rack 10 racks / pack, 5 packs / case	500*450*265	8.8
PT0200-9-YS	10-200µl	Yellow Pre-Sterilized	96 tips / rack 10 racks / pack, 5 packs / case	500*450*265	8.8
 PT0200-9-YS-LB	10-200µl	Yellow Low Retention, Pre-Sterilized	96 tips / rack 10 racks / pack, 5 packs / case	500*450*265	8.8
PT0200-E2-Y	10-200µl	Yellow	96 tips / rack 10 racks / pack, 10 packs / case	455*270*265	7.5
 PT0200-E2-Y-LB	10-200µl	Yellow Low Retention	96 tips / rack 10 racks / pack, 10 packs / case	455*270*265	7.5

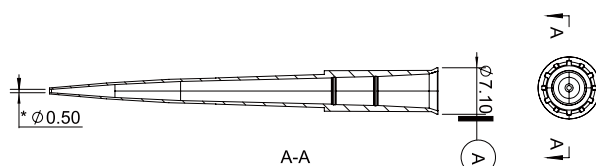
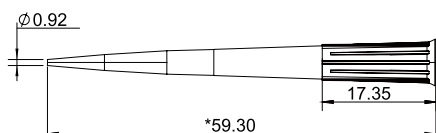

300µl with graduation marks at 10µl, 50µl and 100µl

GEB Cat#	Volume	Type	Packaging Specification	Carton Size L*W*H(mm)	Weight KGs
PT0300-B-N	10-300µl	Natural	1000 tips / bag , 20 bags / case	595*325*310	8.82
 PT0300-B-N-LB	10-300µl	Natural Low Retention	1000 tips / bag , 20 bags / case	595*325*310	8.82
PT0300-9-N	10-300µl	Natural	96 tips / rack 10 racks / pack, 5 packs / case	500*450*310	9.00
 PT0300-9-N-LB	10-300µl	Natural Low Retention	96 tips / rack 10 racks / pack, 5 packs / case	500*450*310	9.00
PT0300-9-NS	10-300µl	Natural Pre-Sterilized	96 tips / rack 10 racks / pack, 5 packs / case	500*450*310	9.00
 PT0300-9-NS-LB	10-300µl	Natural Low Retention, Pre-Sterilized	96 tips / rack 10 racks / pack, 5 packs / case	500*450*310	9.00
PT0300-E2-N	10-300µl	Natural	96 tips / rack 10 racks / pack, 10 packs / case	455*270*265	9.00
 PT0300-E2-N-LB	10-300µl	Natural Low Retention	96 tips / rack 10 racks / pack, 10 packs / case	455*270*265	9.00



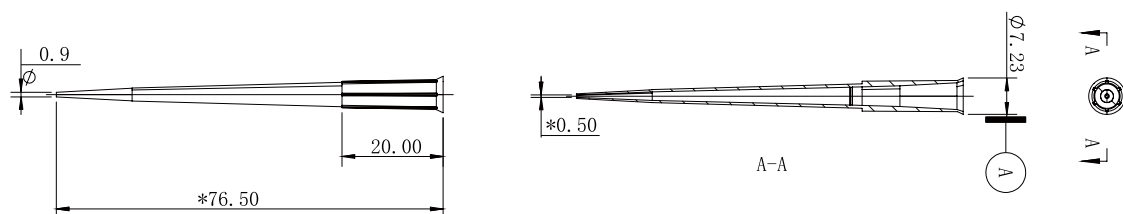

Pipette Tips without Aerosol Barrier

Tips Compatible for a wide range of pipettors
Universal Fit



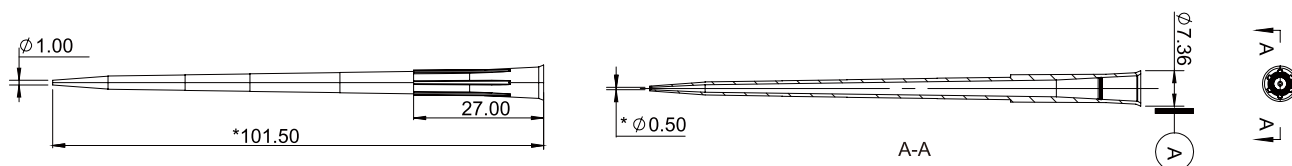

300µl Long Version with graduation marks at 10µl, 50µl, 100µl and 200µl

GEB Cat#	Volume	Type	Packaging Specification	Carton Size L*W*H(mm)	Weight KGs
PTL0300-B-N	10-300µl	Natural	1000 tips / bag , 20 bags / case	595*325*310	8.82
 PTL0300-B-N-LB	10-300µl	Natural Low Retention	1000 tips / bag , 20 bags / case	595*325*310	8.82
PTL0300-9-N	10-300µl	Natural	96 tips / rack 10 racks / pack, 5 packs / case	500*450*310	9.00
 PTL0300-9-N-LB	10-300µl	Natural Low Retention	96 tips / rack 10 racks / pack, 5 packs / case	500*450*310	9.00
PTL0300-9-NS	10-300µl	Natural Pre-Sterilized	96 tips / rack 10 racks / pack, 5 packs / case	500*450*310	9.00
 PTL0300-9-NS-LB	10-300µl	Natural Low Retention, Pre-Sterilized	96 tips / rack 10 racks / pack, 5 packs / case	500*450*310	9.00



300µl Long Version with graduation marks at 10µl, 50µl, 100µl, 200µl and 300µl

GEB Cat#	Volume	Type	Packaging Specification	Carton Size L*W*H(mm)	Weight KGs
PTXL0300-B-N	10-300µl	Natural	1000 tips / bag , 20 bags / case	595*325*310	8.82
 PTXL0300-B-N-LB	10-300µl	Natural Low Retention	1000 tips / bag , 20 bags / case	595*325*310	8.82
PTXL0300-9-N	10-300µl	Natural	96 tips / rack 10 racks / pack, 5 packs / case	495*285*650	13.5
 PTXL0300-9-N-LB	10-300µl	Natural Low Retention	96 tips / rack 10 racks / pack, 5 packs / case	495*285*650	13.5
PTXL0300-9-NS	10-300µl	Natural Pre-Sterilized	96 tips / rack 10 racks / pack, 5 packs / case	495*285*650	13.5
 PTXL0300-9-NS-LB	10-300µl	Natural Low Retention, Pre-Sterilized	96 tips / rack 10 racks / pack, 5 packs / case	495*285*650	13.5





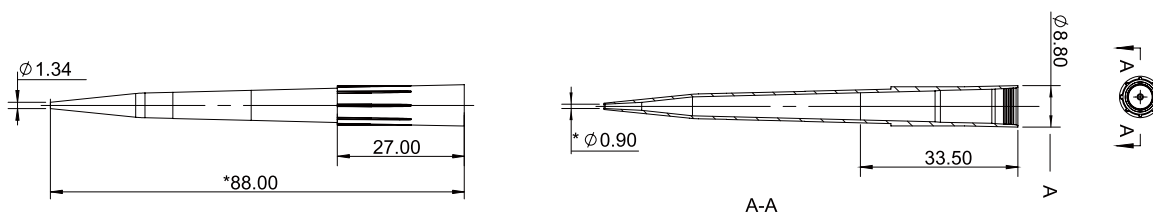

Pipette Tips without Aerosol Barrier

Tips Compatible for a wide range of pipettors
Universal Fit



1000µl with graduation marks at 100µl, 200µl and 500µl

GEB Cat#	Volume	Type	Packaging Specification	Carton Size L*W*H(mm)	Weight KGs
PT1000-B-B	100-1000µl	Blue	1000 tips / bag , 5 bags / case	690*235*330	5.8
 PT1000-B-B-LB	100-1000µl	Blue Low Retention	1000 tips / bag , 5 bags / case	690*235*330	5.8
PT1000-1-B	100-1000µl	Blue	96 tips / rack 10 racks / pack, 5 packs / case	595*285*475	15.0
 PT1000-1-B-LB	100-1000µl	Blue Low Retention	96 tips / rack 10 racks / pack, 5 packs / case	595*285*475	15.0
PT1000-1-BS	100-1000µl	Blue Pre-Sterilized	96 tips / rack 10 racks / pack, 5 packs / case	595*285*475	15.0
 PT1000-1-BS-LB	100-1000µl	Blue Low Retention , Pre-Sterilized	96 tips / rack 10 racks / pack, 5 packs / case	595*285*475	15.0
PT1000-E2-B	100-1000µl	Blue	96 tips / rack 5 racks / stack, 10 stacks / case	455*270*265	8.0
 PT1000-E2-B-LB	100-1000µl	Blue Low Retention	96 tips / rack 5 racks / stack, 10 stacks / case	455*270*265	8.0

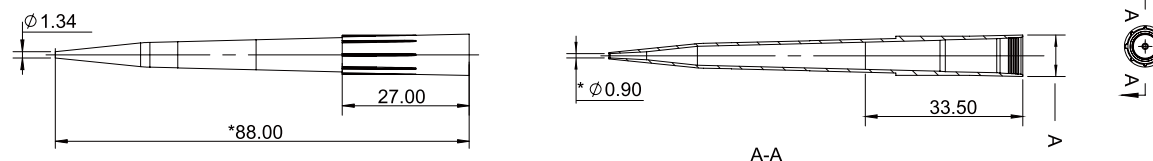

1250µl with graduation marks at 50µl, 100µl, 200µl and 500µl

GEB Cat#	Volume	Type	Packaging Specification	Carton Size L*W*H(mm)	Weight KGs
PT1250-B-N	100-1250µl	Natural	1000 tips / bag , 5 bags / case	690*235*330	5.8
 PT1250-B-N-LB	100-1250µl	Natural Low Retention	1000 tips / bag , 5 bags / case	690*235*330	5.8
PT1250-9-N	100-1250µl	Natural	96 tips / rack 10 racks / pack, 5 packs / case	595*285*475	15.0
 PT1250-9-N-LB	100-1250µl	Natural Low Retention	96 tips / rack 10 racks / pack, 5 packs / case	595*285*475	15.0
PT1250-9-NS	100-1250µl	Natural Pre-Sterilized	96 tips / rack 10 racks / pack, 5 packs / case	595*285*475	15.0
 PT1250-9-NS-LB	100-1250µl	Natural Low Retention , Pre-Sterilized	96 tips / rack 10 racks / pack, 5 packs / case	595*285*475	15.0
PT1250-E2-N	100-1250µl	Natural	96 tips / rack 5 racks / stack, 10 stacks / case	455*270*265	8.0
 PT1250-E2-N-LB	100-1250µl	Natural Low Retention	96 tips / rack 5 racks / stack, 10 stacks / case	455*270*265	8.0



Pipette Tips without Aerosol Barrier

Tips Compatible for a wide range of pipettors

Universal Fit

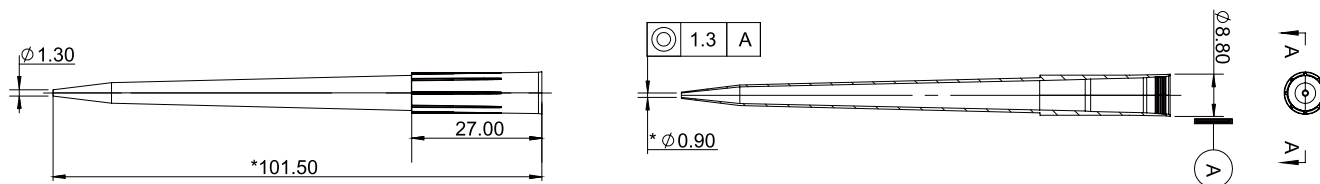

1250µl Long Version with graduation marks at 50µl, 100µl, 200µl and 500µl

GEB Cat#	Volume	Type	Packaging Specification	Carton Size L*W*H(mm)	Weight KGs	
	PTL1250-B-N	100-1250µl	Natural	1000 tips / bag , 5 bags /case	690*235*330	5.8
	PTL1250-B-N-LB	100-1250µl	Low Retention	1000 tips / bag , 5 bags /case	690*235*330	5.8
	PTL1250-9-N	100-1250µl	Natural	96 tips / rack 10racks / pack, 5 packs / case	595*285*475	13.0
	PTL1250-9-N-LB	100-1250µl	Low Retention	96 tips / rack 10racks / pack, 5 packs / case	595*285*475	13.0
	PTL1250-9-NS	100-1250µl	Natural Pre-Sterilized	96 tips / rack 10racks / pack, 5 packs / case	595*285*475	13.0
	PTL1250-9-NS-LB	100-1250µl	Natural Low Retention, Pre-Sterilized	96 tips / rack 10racks / pack, 5 packs / case	595*285*475	13.0
	PTL1250-E2-N	100-1250µl	Natural	96 tips / rack 5 racks / stack, 10stacks /case	455*270*265	8.2
	PT1250-E2-N-LB	100-1250µl	Natural Low Retention	96 tips / rack 5 racks / stack, 10stacks /case	455*270*265	8.2



Pipette Tips with Aerosol Barrier

Tips Compatible for a wide range of pipettors

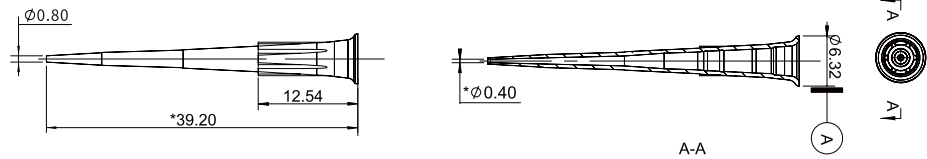
Universal Fit



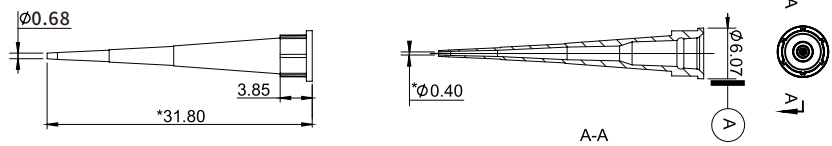

10µl, with graduation marks at 2µl and 10µl (Extended length tip allows easy access to narrow, deep wells)

GEB Cat#	Volume	Type	Packaging Specification	Carton Size L*W*H(mm)	Weight KGs
FT0010-B-N	0.5-10µl	Natural, Filtered	1000 tips / bag , 10 bags / case	450*270*190	4.5
 FT0010-B-N-LB	0.5-10µl	Natural Filtered, Low Retention	1000 tips / bag , 10 bags / case	450*270*190	4.5
FT0010-R-NS	0.5-10µl	Natural Filtered, Pre-Sterilized	96 tips / rack 10 racks / pack, 5 packs / case	480*345*280	8.2
 FT0010-R-NS-LB	0.5-10µl	Natural, Filtered Pre-Sterilized, Low Retention	96 tips / rack 10 racks / pack, 5 packs / case	480*345*280	8.2



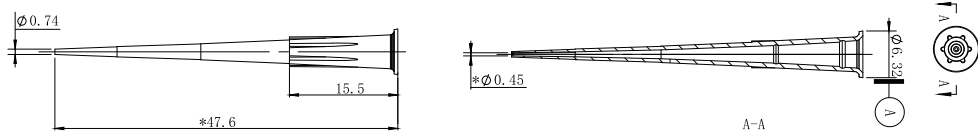

10µl, with graduation marks at 2µl and 10µl

GEB Cat#	Volume	Type	Packaging Specification	Carton Size L*W*H(mm)	Weight KGs
FTS0010-B-N	0.5-10µl	Natural, Filtered	1000 tips / bag , 10 bags / case	450*270*190	4.5
 FTS0010-B-N-LB	0.5-10µl	Natural Filtered, Low Retention	1000 tips / bag , 10 bags / case	450*270*190	4.5
FTS0010-R-NS	0.5-10µl	Natural Filtered, Pre-Sterilized	96 tips / rack 10 racks / pack, 5 packs / case	480*345*280	7.6
 FTS0010-R-NS-LB	0.5-10µl	Natural, Filtered Pre-Sterilized, Low Retention	96 tips / rack 10 racks / pack, 5 packs / case	480*345*280	7.6



10µl Long Version with graduation marks at 2µl and 10µl

GEB Cat#	Volume	Type	Packaging Specification	Carton Size L*W*H(mm)	Weight KGs
FTL0010-B-N	0.5-10µl	Natural, Filtered	1000 tips / bag , 10 bags / case	450*270*190	5.0
 FTL0010-B-N-LB	0.5-10µl	Natural Filtered, Low Retention	1000 tips / bag , 10 bags / case	450*270*190	5.0
FTL0010-R-NS	0.5-10µl	Natural Filtered, Pre-Sterilized	96 tips / rack 10 racks / pack, 5 packs / case	480*345*280	10.0
 FTL0010-R-NS-LB	0.5-10µl	Natural, Filtered Pre-Sterilized, Low Retention	96 tips / rack 10 racks / pack, 5 packs / case	480*345*280	10.0



Pipette Tips with Aerosol Barrier

Tips Compatible for a wide range of pipettors

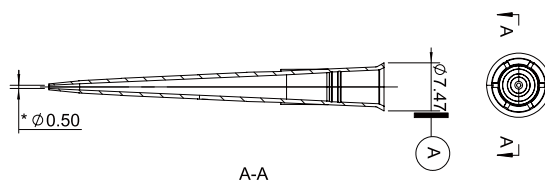
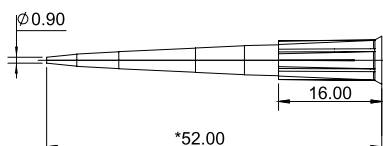
Universal Fit



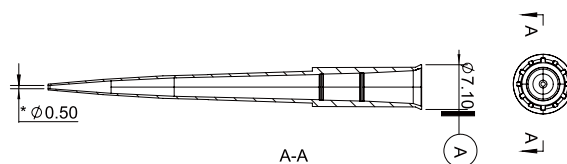
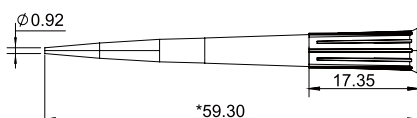

20µl, with graduation marks at 10µl

GEB Cat#	Volume	Type	Packaging Specification	Carton Size L*W*H(mm)	Weight KGs
FT0020-B-N	1.0-20µl	Natural, Filtered	1000 tips / bag , 10 bags / case	480*345*280	5.0
 FT0020-B-N-LB	1.0-20µl	Natural Filtered, Low Retention	1000 tips / bag , 10 bags / case	480*345*280	5.0
FT0020-R-NS	1.0-20µl	Natural Filtered, Pre-Sterilized	96 tips / rack 10 racks / pack, 5 packs / case	500*265*450	10.0
 FT0020-R-NS-LB	1.0-20µl	Natural, Filtered Pre-Sterilized, Low Retention	96 tips / rack 10 racks / pack, 5 packs / case	500*265*450	10.0



100µl, with graduation marks at 10µl, 50µl

GEB Cat#	Volume	Type	Packaging Specification	Carton Size L*W*H(mm)	Weight KGs
FT0100-B-N	10-100µl	Natural, Filtered	1000 tips / bag , 10 bags / case	480*345*280	4.5
 FT0100-B-N-LB	10-100µl	Natural Filtered, Low Retention	1000 tips / bag , 10 bags / case	480*345*280	4.5
FT0100-R-NS	10-100µl	Natural Filtered, Pre-Sterilized	96 tips / rack 10 racks / pack, 5 packs / case	500*265*450	9.5
 FT0100-R-NS-LB	10-100µl	Natural, Filtered Pre-Sterilized, Low Retention	96 tips / rack 10 racks / pack, 5 packs / case	500*265*450	9.5





Pipette Tips with Aerosol Barrier

Tips Compatible for a wide range of pipettors

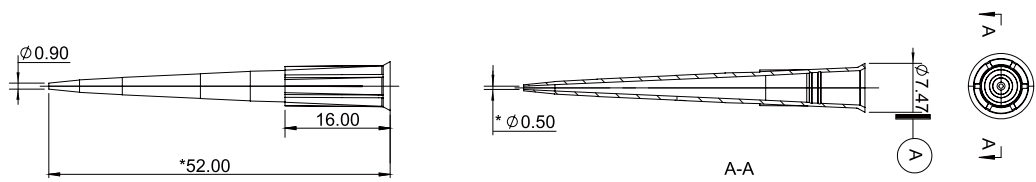
Universal Fit



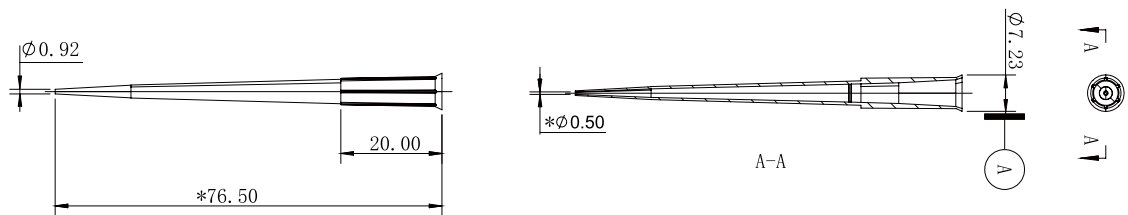

200µl, with graduation marks at 10µl, 50µl and 100µl

GEB Cat#	Volume	Type	Packaging Specification	Carton Size L*W*H(mm)	Weight KGs
FT0200-B-N	10-200µl	Natural, Filtered	1000 tips / bag , 10 bags/case	480*345*280	4.1
 FT0200-B-N-LB	10-200µl	Natural Filtered, Low Retention	1000 tips / bag , 10 bags/case	480*345*280	4.1
 FT0200-R-NS	10-200µl	Natural Filtered, Pre-Sterilized	96 tips / rack 10racks / pack, 5 packs / case	500*265*450	9.5
 FT0200-R-NS-LB	10-200µl	Natural, Filtered Pre-Sterilized, Low Retention	96 tips / rack 10racks / pack, 5 packs / case	500*265*450	9.5



200µl Long Version with graduation marks at 10µl, 50µl, 100µl and 200µl

GEB Cat#	Volume	Type	Packaging Specification	Carton Size L*W*H(mm)	Weight KGs
FTL0200-B-N	10-200µl	Natural, Filtered	1000 tips / bag , 10 bags/case	480*345*280	5.1
 FTL0200-B-N-LB	10-200µl	Natural Filtered, Low Retention	1000 tips / bag , 10 bags/case	480*345*280	5.1
 FTL0200-R-NS	10-200µl	Natural Filtered, Pre-Sterilized	96 tips / rack 10racks / pack, 5 packs / case	500*265*450	9.5
 FTL0200-R-NS-LB	10-200µl	Natural, Filtered Pre-Sterilized, Low Retention	96 tips / rack 10racks / pack, 5 packs / case	500*265*450	9.5



Pipette Tips with Aerosol Barrier

Tips Compatible for a wide range of pipettors

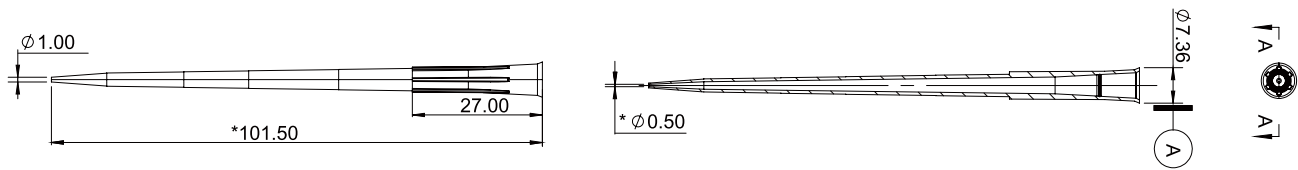
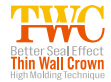
Universal Fit



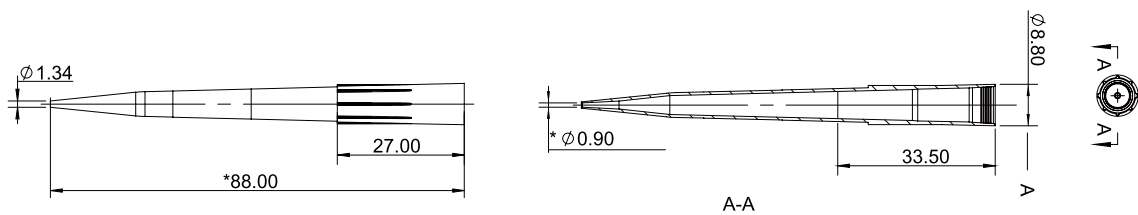

300µl Long Version with graduation marks at 10µl, 50µl, 100µl, 200µl and 300µl

GEB Cat#	Volume	Type	Packaging Specification	Carton Size L*W*H(mm)	Weight KGs
FTXL0300-B-N	10-300µl	Natural, Filtered	1000 tips / bag , 10 bags / case	595*325*310	8.82
 FTXL0300-B-N-LB	10-300µl	Natural Filtered, Low Retention	1000 tips / bag , 10 bags / case	595*325*310	8.82
FTXL0300-R-NS	10-300µl	Natural Filtered, Pre-Sterilized	96 tips / rack 10 racks / pack, 5 packs / case	495*285*650	13.5
 FTXL0300-R-NS-LB	10-300µl	Natural, Filtered Pre-Sterilized, Low Retention	96 tips / rack 10 racks / pack, 5 packs / case	495*285*650	13.5



500µl, with graduation marks at 100µl, 200µl and 500µl

GEB Cat#	Volume	Type	Packaging Specification	Carton Size L*W*H(mm)	Weight KGs
FT0500-B-N	100-500µl	Natural, Filtered	1000 tips / bag , 5 bags / case	690*235*330	5.9
 FT0500-B-N-LB	100-500µl	Natural Filtered, Low Retention	1000 tips / bag , 5 bags / case	690*235*330	5.9
FT0500-R-NS	100-500µl	Natural Filtered, Pre-Sterilized	96 tips / rack 10 racks / pack, 5 packs / case	595*285*475	13.5
 FT0500-R-NS-LB	100-500µl	Natural, Filtered Pre-Sterilized, Low Retention	96 tips / rack 10 racks / pack, 5 packs / case	595*285*475	13.5





Pipette Tips with Aerosol Barrier

Tips Compatible for a wide range of pipettors

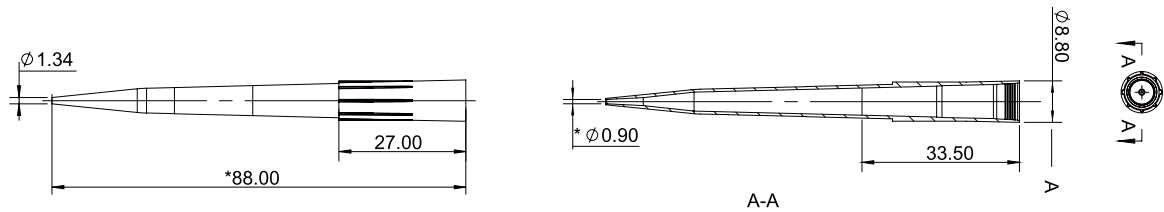
Universal Fit



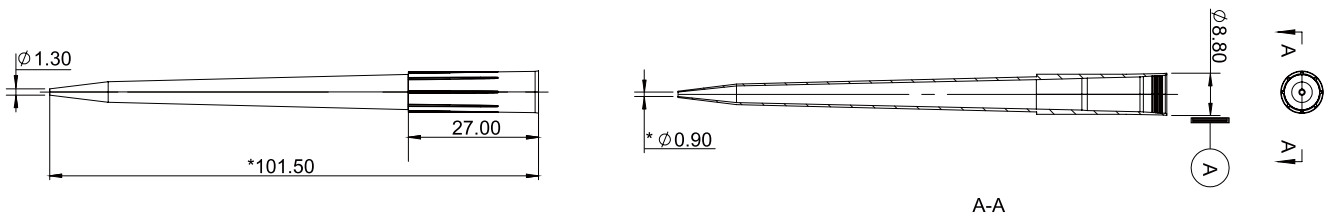

1000µl, with graduation marks at 50µl, 100µl, 200µl and 500µl

GEB Cat#	Volume	Type	Packaging Specification	Carton Size L*W*H(mm)	Weight KGs
FT1000-B-N	100-1000µl	Natural, Filtered	1000 tips / bag , 5 bags / case	690*235*330	5.8
 FT1000-B-N-LB	100-1000µl	Natural Filtered, Low Retention	1000 tips / bag , 5 bags / case	690*235*330	5.8
FT1000-R-NS	100-1000µl	Natural Filtered, Pre-Sterilized	96 tips / rack 10 racks / pack, 5 packs / case	595*285*475	15.0
 FT1000-R-NS-LB	100-1000µl	Natural, Filtered Pre-Sterilized, Low Retention	96 tips / rack 10 racks / pack, 5 packs / case	595*285*475	15.0



1250µl Long Version with graduation marks at 50µl, 100µl, 200µl and 500µl

GEB Cat#	Volume	Type	Packaging Specification	Carton Size L*W*H(mm)	Weight KGs
FTL1250-B-N	100-1250µl	Natural, Filtered	1000 tips / bag , 5 bags / case	690*235*330	5.8
 FTL1250-B-N-LB	100-1250µl	Natural Filtered, Low Retention	1000 tips / bag , 5 bags / case	690*235*330	5.8
FTL1250-R-NS	100-1250µl	Natural Filtered, Pre-Sterilized	96 tips / rack 10 racks / pack, 5 packs / case	650*285*495	13.5
 FTL1250-R-NS-LB	100-1250µl	Natural, Filtered Pre-Sterilized, Low Retention	96 tips / rack 10 racks / pack, 5 packs / case	650*285*495	13.5



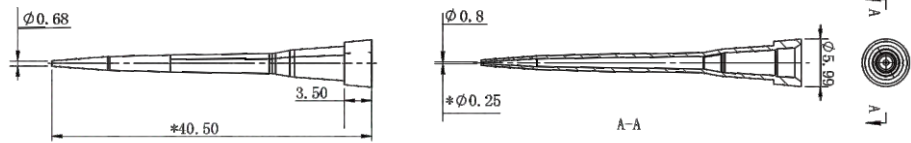

TIPS

Compatible with
Eppendorf



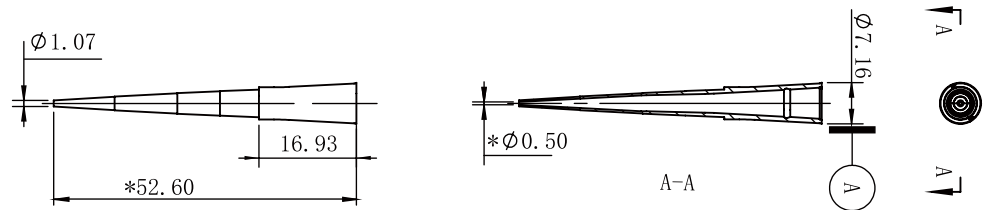

10µl

GEB Cat#	Volume	Type	Packaging Specification	Carton Size L*W*H(mm)	Weight KGs
PTE0010-B-N	0.5-10µl	Natural	1000 tips / bag , 20 bags / case	455*265*255	7.6
 PTE0010-B-N-LB	0.5-10µl	Natural Low Retention	1000 tips / bag , 20 bags / case	455*265*255	7.6
PTE0010-9-N	0.5-10µl	Natural	96 tips / rack 10racks / pack, 5 packs / case	480*345*280	7.6
 PTE0010-9-N-LB	0.5-10µl	Natural Low Retention	96 tips / rack 10racks / pack, 5 packs / case	480*345*280	7.6
PTE0010-9-NS	0.5-10µl	Natural Pre-Sterilized	96 tips / rack 10racks / pack, 5 packs / case	480*345*280	7.6
 PTE0010-9-NS-LB	0.5-10µl	Natural Low Retention, Pre-Sterilized	96 tips / rack 10racks / pack, 5 packs / case	480*345*280	7.6



200µl

GEB Cat#	Volume	Type	Packaging Specification	Carton Size L*W*H(mm)	Weight KGs
PTE0200-B-N	10-200µl	Natural	1000 tips / bag , 20 bags / case	595*325*310	6.9
 PTE0200-B-N-LB	10-200µl	Natural Low Retention	1000 tips / bag , 20 bags / case	595*325*310	6.9
PTE0200-9-N	10-200µl	Natural	96 tips / rack 10racks / pack, 5 packs / case	500*450*265	8.8
 PTE0200-9-N-LB	10-200µl	Natural Low Retention	96 tips / rack 10racks / pack, 5 packs / case	500*450*265	8.8
PTE0200-9-NS	10-200µl	Natural Pre-Sterilized	96 tips / rack 10racks / pack, 5 packs / case	500*450*265	8.8
 PTE0200-9-NS-LB	10-200µl	Natural Low Retention, Pre-Sterilized	96 tips / rack 10racks / pack, 5 packs / case	500*450*265	8.8



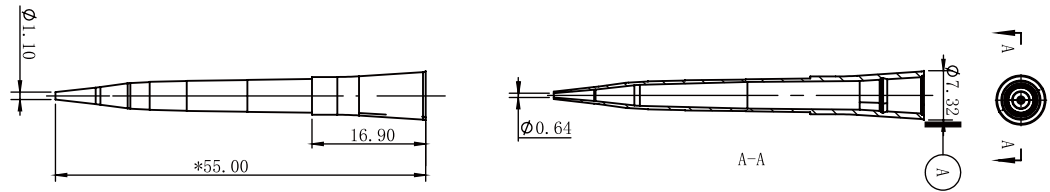

TIPS

Compatible with
Eppendorf



300µl



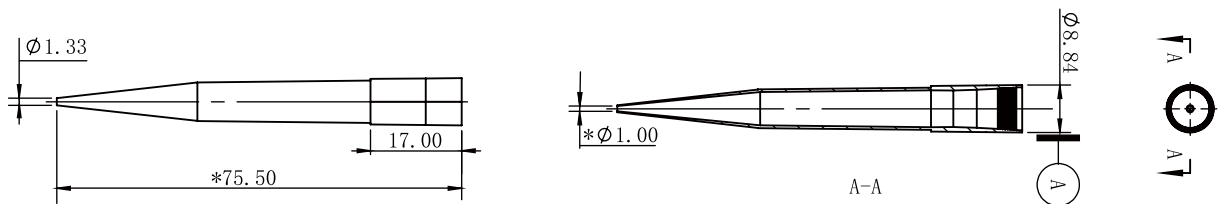

GEB Cat#	Volume	Type	Packaging Specification	Carton Size L*W*H(mm)	Weight KGs
PTE0300-B-N	10-300µl	Natural	1000 tips / bag , 20 bags / case	595*365*360	8.82
 PTE0300-B-N-LB	10-300µl	Natural Low Retention	1000 tips / bag , 20 bags / case	595*365*360	8.82
PTE0300-9-N	10-300µl	Natural	96 tips / rack 10racks / pack, 5 packs / case	500*450*265	9.00
 PTE0300-9-N-LB	10-300µl	Natural Low Retention	96 tips / rack 10racks / pack, 5 packs / case	500*450*265	9.00
PTE0300-9-NS	10-300µl	Natural Pre-Sterilized	96 tips / rack 10racks / pack, 5 packs / case	500*450*265	9.00
 PTE0300-9-NS-LB	10-300µl	Natural Low Retention , Pre-Sterilized	96 tips / rack 10racks / pack, 5 packs / case	500*450*265	9.00



1000µl



GEB Cat#	Volume	Type	Packaging Specification	Carton Size L*W*H(mm)	Weight KGs
PTE1000-B-N	100-1000µl	Natural	1000 tips / bag , 5 bags / case	690*235*330	5.8
 PTE1000-B-N-LB	100-1000µl	Natural Low Retention	1000 tips / bag , 5 bags / case	690*235*330	5.8
PTE1000-9-N	100-1000µl	Natural	96 tips / rack 10racks / pack, 5 packs / case	595*285*475	15.0
 PTE1000-9-N-LB	100-1000µl	Natural Low Retention	96 tips / rack 10racks / pack, 5 packs / case	595*285*475	15.0
PTE1000-9-NS	100-1000µl	Natural Pre-Sterilized	96 tips / rack 10racks / pack, 5 packs / case	595*285*475	15.0
 PTE1000-9-NS-LB	100-1000µl	Natural Low Retention , Pre-Sterilized	96 tips / rack 10racks / pack, 5 packs / case	595*285*475	15.0

Tip Series - Compatibility

BRAND OF PIPETTOR	VOLUME RANGE	PT0010	PT0200	PT0300	PT1000	PTL1250	FT0010	FT0020	FT0100	FT0200	FT0500	FT1000	FTL1250
BIOHIT													
PROLINE-Single channel	0.2-10µl	✓					✓	✓					
	5-100µl		✓						✓				
	10-250µl		✓	✓					✓	✓			
	10-500µl				✓						✓		
	50-1000µl				✓	✓					✓	✓	✓
PROLINE-Multi channel	0.2-10µl	✓						✓					
	5-100µl		✓						✓				
	25-250µl		✓	✓					✓	✓			
E-LINE-Single channel	0.2-10µl	✓					✓						
	5-120µl		✓						✓	✓			
	10-300µl		✓	✓				✓	✓	✓			
	50-1000µl		✓		✓	✓					✓	✓	✓
E-LINE-Multi channel	0.2-10µl	✓					✓						
	5-120µl		✓						✓				
	10-300µl		✓	✓					✓	✓			
M-LINE-Single channel	0.5-10µl	✓					✓						
	2-20µl		✓				✓						
	10-100µl		✓						✓				
	20-200µl		✓	✓					✓	✓			
	100-1000µl				✓	✓					✓	✓	✓
M-LINE-Multi channel	0.5-10µl	✓					✓						
	5-100µl		✓					✓	✓				
	30-300µl		✓	✓					✓	✓			
MATRIX													
Impact/Impact2-Single channel	2-125 µl		✓							✓			
	5-250µl									✓			
	15-1250µl												
Impact/Impact2-Multi channel	2-125 µl		✓				✓						
	5-250µl			✓						✓			
	15-1250µl												

GEB, Your Better Choice

Tip Series - Compatibility

BRAND OF PIPETTOR	VOLUME RANGE	PT0010	PT0200	PT0300	PT1000	PTL1250	FT0010	FT0020	FT0100	FT0200	FT0500	FT1000	FTL1250
BRANDTECH													
TRANSFERPETTE-Single channel	0.1-1µl	✓					✓	✓					
	0.5-10µl	✓					✓	✓					
	2-20µl		✓					✓					
	5-50µl		✓	✓				✓	✓				
	10-100µl		✓						✓				
	20-200µl		✓	✓					✓	✓			
	25-250µl		✓	✓					✓	✓			
	100-1000µl				✓	✓						✓	✓
TRANSFERPETTE-Multi channel	0.5-10µl	✓					✓	✓					
	2-20µl	✓	✓				✓	✓					
	2.5-25µl		✓					✓					
	5-50µl		✓					✓					
	10-100µl		✓					✓					
	20-200µl		✓	✓					✓	✓			
	30-300µl		✓	✓					✓	✓		✓	
CAPP AERO													
Pipettor-Single channel	0.2-10µl	✓					✓	✓					
	0.5-10µl	✓					✓	✓					
	2-20µl		✓					✓	✓				
	10-100µl		✓						✓				
	25-200µl		✓	✓						✓			
	50-300µl		✓	✓					✓	✓			
	100-1000µl				✓	✓						✓	✓
Pipettor-Multi channel	0.2-10µl	✓					✓	✓					
	0.5-10µl	✓					✓	✓					
	2-20µl		✓					✓	✓				
	10-100µl		✓	✓					✓	✓			
	25-200µl		✓	✓					✓	✓			
	50-300µl		✓	✓					✓	✓			
	100-1000µl				✓	✓					✓	✓	✓

Tip Series - Compatibility

BRAND OF PIPETTOR	VOLUME RANGE	PT0010	PT0200	PT0300	PT1000	PTL1250	FT0010	FT0020	FT0100	FT0200	FT0500	FT1000	FTL1250
EPPENDORF													
ELECTRONIC	0.5-10µl	✓					✓	✓					
	5-100µl		✓						✓	✓			
	20-200µl		✓	✓					✓	✓			
	50-1000µl				✓	✓					✓	✓	
REFERENCE	0.1-1µl	✓					✓						
	2-20 µl		✓										
	10-100µl		✓						✓	✓			
	20-200µl		✓	✓					✓	✓			
	100-1000µl				✓	✓					✓	✓	✓
RESEARCH-Single channel	0.1-2.5µl	✓					✓						
	0.5-10µl	✓					✓						
	2-20 µl		✓										
	10-100µl		✓				✓						
	20-200µl		✓	✓									
	100-1000µl				✓	✓						✓	✓
RESEARCH-Multi channel	0.5-10µl	✓					✓						
	5-100µl		✓						✓				
	50-100µl		✓						✓	✓			
	20-300µl		✓	✓						✓			
	30-300µl		✓	✓									
	50-1200µl				✓	✓							
THERMOLABSYSTEMS													
FINNPIPETTE-Single channel	0.2-10µl	✓					✓						
	0.5-10µl	✓					✓						
	5-40µl		✓						✓				
	40-200µl		✓	✓						✓			
	100-1000µl				✓	✓					✓	✓	✓
	200-1000µl				✓	✓					✓	✓	✓
FINNPIPETTE-Multi channel	5-50µl		✓						✓				
	50-300µl		✓	✓					✓	✓			

GEB, Your Better Choice

Tip Series - Compatibility

BRAND OF PIPETTOR	VOLUME RANGE	PT0010	PT0200	PT0300	PT1000	PTL1250	FT0010	FT0020	FT0100	FT0200	FT0500	FT1000	FTL1250
GILSON													
PIPETMAN-Single channel	0.1-2µl	✓					✓						
	0.2-10µl	✓					✓						
	2-20µl		✓										
	10-100µl		✓	✓				✓	✓	✓			
	20-200µl		✓	✓				✓	✓	✓			
	100-1000µl					✓	✓					✓	✓
PIPETMAN-Multi channel	20-200µl		✓	✓						✓	✓	✓	
NICHIRYO/OXFORD													
Benchmate	0.5-10µl	✓					✓						
	2-20µl		✓					✓					
	10-50µl		✓					✓	✓				
	10-100µl												
	20-200µl												
	100-1000µl												
RAININ													
EDP3-Single-channel	0.5-10µl	✓					✓						
	2.5-25µl		✓						✓				
	10-100µl		✓	✓					✓	✓			
	25-250µl		✓	✓					✓	✓			
	100-1000µl					✓	✓					✓	✓
EDP3-Multi-channel	0.5-10µl	✓					✓						
	10-250µl		✓	✓				✓	✓	✓			
LATCH MODE	0.1-2µl	✓					✓						
	0.2-10µl	✓											
	2-20µl		✓					✓					
	10-100µl		✓	✓				✓	✓	✓			
	20-200µl		✓	✓				✓	✓	✓			
	100-1000µl					✓	✓					✓	✓

Tip Series - Compatibility

BRAND OF PIPETTOR	VOLUME RANGE	PT0010	PT0200	PT0300	PT1000	PTL1250	FT0010	FT0020	FT0100	FT0200	FT0500	FT1000	FTL1250
SOCORE													
CALIBRA/ACURA-Single channel	0.1-1µl	✓					✓						
	0.5-10µl	✓					✓						
	2-20µl		✓					✓					
	5-50µl		✓						✓				
	10-100µl		✓					✓	✓				
	20-200µl		✓	✓				✓	✓	✓			
	25-250µl		✓	✓						✓			
	100-1000µl					✓	✓					✓	✓
CALIBRA/ACURA-Multi channel	2.5-25µl		✓						✓				
	5-50µl		✓					✓					
	10-100µl		✓	✓				✓	✓				
	20-200µl		✓	✓				✓	✓	✓			
	30-300µl		✓	✓					✓	✓			
VWR													
SIGNATURE-Single channel	0.1-2µl	✓					✓						
	0.5-10µl	✓					✓						
	2-20µl		✓					✓	✓				
	5-100µl		✓						✓				
	10-100µl		✓	✓				✓	✓	✓			
	20-200µl		✓	✓				✓	✓	✓			
	50-250µl		✓	✓					✓				
	100-1000µl					✓	✓					✓	✓
SIGNATURE-Multi channel	1-10µl	✓					✓						
	5-50µl		✓					✓	✓				
	20-200µl		✓	✓				✓	✓	✓			
	50-300µl		✓	✓					✓	✓			

TIPS

Compatible with

Rainin



Format: 96-tip format
 Tip Volume range selection: 10µl
 Material: Virgin Polypropylene
 Alternatives:
 ○ With/without aerosol-barrier filter
 ○ Pre-Sterilized/Non-Sterilized
 ○ Low Retention/Standard
 Certified:
 DNase-Free, RNase-Free, Endotoxin-Safe

Material: Polypropylene

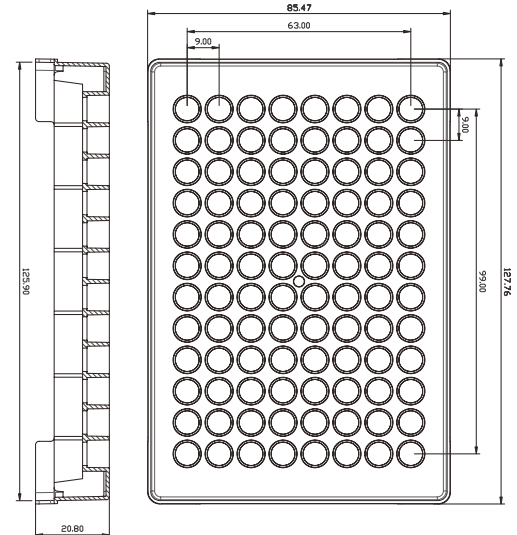
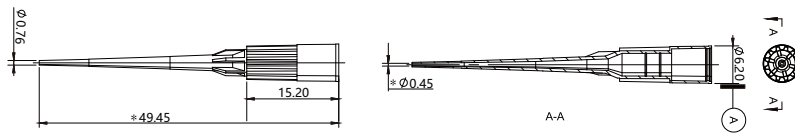







10µl

	GEB Cat#	Max Volume	Tip Color	Packaging Specification	Carton Size L*W*H(mm)	Weight KGs
	AT010R-B-N	10µl	Natural	1000 tips / bag, 20bags / case	455*270*265	3.2
	AT010R-B-N-LB	10µl	Natural Low Retention	1000 tips / bag, 20bags / case	455*270*265	3.2
	AT010R-9-N	10µl	Natural	96 tips/rack, 10 racks/pack, 5 packs/case	480*345*280	7.8
	AT010R-9-N-LB	10µl	Natural Low Retention	96 tips/rack, 10 racks/pack, 5 packs/case	480*345*280	7.8
	AT010R-9-NS	10µl	Natural Pre-Sterilized	96 tips/rack, 10 racks/pack, 5 packs/case	480*345*280	7.8
	AT010R-9-NS-LB	10µl	Natural Pre-Sterilized, Low Retention	96 tips/rack, 10 racks/pack, 5 packs/case	480*345*280	7.8
	AF010R-9-NS	10µl	Natural Filtered, Pre-Sterilized	96 tips/rack, 10 racks/pack, 5 packs/case	480*345*280	7.8
	AF010R-9-NS-LB	10µl	Natural, Low Retention Filtered, Pre-Sterilized	96 tips/rack, 10 racks/pack, 5 packs/case	480*345*280	7.8

AT/AF010R-9

10µl

GEB Cat#	Max Volume	Tip Color	Packaging Specification	Carton Size L*W*H(mm)	Weight KGs
AT010R-R-N	10µl	Natural	96 tips/rack, 10 racks/pack, 5 packs/case	500*265*450	7.35
 AT010R-R-N-LB	10µl	Natural, Low Retention	96 tips/rack, 10 racks/pack, 5 packs/case	500*265*450	7.35
 AT/AF010R-R	10µl	Natural, Pre-Sterilized	96 tips/rack, 10 racks/pack, 5 packs/case	500*265*450	7.35
 AT010R-R-NS-LB	10µl	Natural Pre-Sterilized, Low Retention	96 tips/rack, 10 racks/pack, 5 packs/case	500*265*450	7.35
AF010R-R-NS	10µl	Natural Filtered, Pre-Sterilized	96 tips/rack, 10 racks/pack, 5 packs/case	500*265*450	7.35
 AF010R-R-NS-LB	10µl	Natural, Low Retention Filtered, Pre-Sterilized	96 tips/rack, 10 racks/pack, 5 packs/case	500*265*450	7.35
 AT010R-E-N	10µl	Natural	96 tips/rack, 10 racks/stacks, 5 stacks/case	455*270*265	6.3
 AT010R-E-N-LB	10µl	Natural Low Retention	96 tips/rack, 10 racks/stacks, 5 stacks/case	455*270*265	6.3

TIPS

Compatible with
Rainin



Format: 96-tip format
 Tip Volume range selection: 20µl
 Material: Virgin Polypropylene
 Alternatives:
 ○ With/without aerosol-barrier filter
 ○ Pre-Sterilized/Non-Sterilized
 ○ Low Retention/Standard
 Certified:
 DNase-Free, RNase-Free, Endotoxin-Safe

Material: Polypropylene

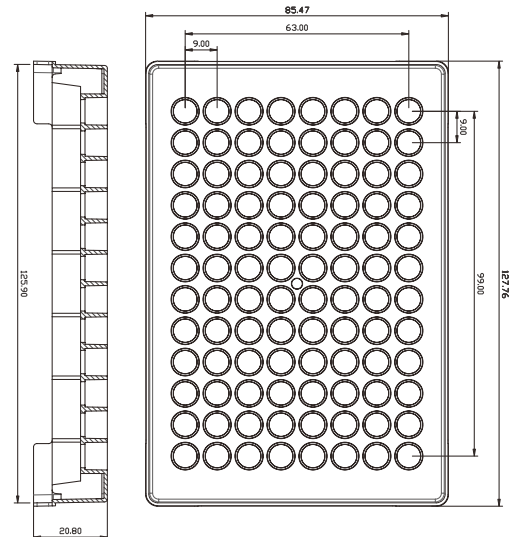
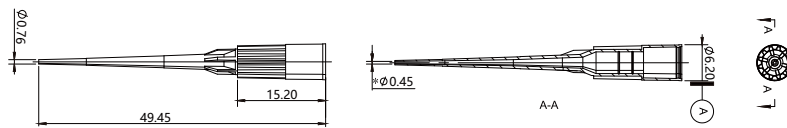





20µl

	GEB Cat#	Max Volume	Tip Color	Packaging Specification	Carton Size L*W*H(mm)	Weight KGs
	AT020R-B-N	20µl	Natural	1000 tips / bag, 20bags / case	455*270*265	3.2
	AT020R-B-N-LB	20µl	Natural Low Retention	1000 tips / bag, 20bags / case	455*270*265	3.2
	AT020R-9-N	20µl	Natural	96 tips/rack, 10 racks/pack, 5 packs/case	480*345*280	7.8
	AT020R-9-N-LB	20µl	Natural Low Retention	96 tips/rack, 10 racks/pack, 5 packs/case	480*345*280	7.8
	AT020R-9-NS	20µl	Natural Pre-Sterilized	96 tips/rack, 10 racks/pack, 5 packs/case	480*345*280	7.8
	AT020R-9-NS-LB	20µl	Natural Pre-Sterilized, Low Retention	96 tips/rack, 10 racks/pack, 5 packs/case	480*345*280	7.8
	AT020R-9-NS	20µl	Natural Filtered, Pre-Sterilized	96 tips/rack, 10 racks/pack, 5 packs/case	480*345*280	7.8
	AF020R-9-NS-LB	20µl	Natural, Low Retention Filtered, Pre-Sterilized	96 tips/rack, 10 racks/pack, 5 packs/case	480*345*280	7.8

AT/AF020R-9

20µl

GEB Cat#	Max Volume	Tip Color	Packaging Specification	Carton Size L*W*H(mm)	Weight KGs
AT020R-R-N	20µl	Natural	96 tips/rack, 10 racks/pack, 5 packs/case	500*265*450	7.35
 AT020R-R-N-LB	20µl	Natural, Low Retention	96 tips/rack, 10 racks/pack, 5 packs/case	500*265*450	7.35
AT020R-R-NS	20µl	Natural, Pre-Sterilized	96 tips/rack, 10 racks/pack, 5 packs/case	500*265*450	7.35
 AT020R-R-NS-LB	20µl	Natural Pre-Sterilized, Low Retention	96 tips/rack, 10 racks/pack, 5 packs/case	500*265*450	7.35
AF020R-R-NS	20µl	Natural Filtered, Pre-Sterilized	96 tips/rack, 10 racks/pack, 5 packs/case	500*265*450	7.35
 AF020R-R-NS-LB	20µl	Natural, Low Retention Filtered, Pre-Sterilized	96 tips/rack, 10 racks/pack, 5 packs/case	500*265*450	7.35
 AT020R-E-N	20µl	Natural	96 tips/rack, 10 racks/stacks, 5 stacks/case	455*270*265	6.3
 AT020R-E-N-LB	20µl	Natural Low Retention	96 tips/rack, 10 racks/stacks, 5 stacks/case	455*270*265	6.3



AT/AF020R-R



AT020R-E

TIPS

Compatible with
Rainin





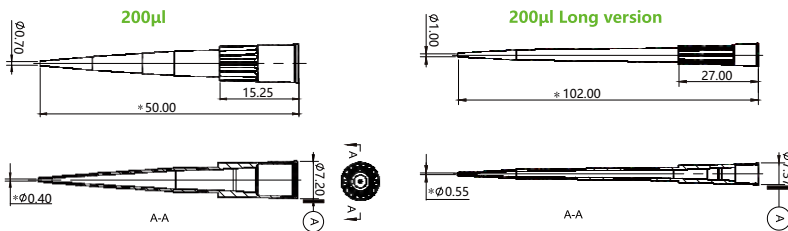
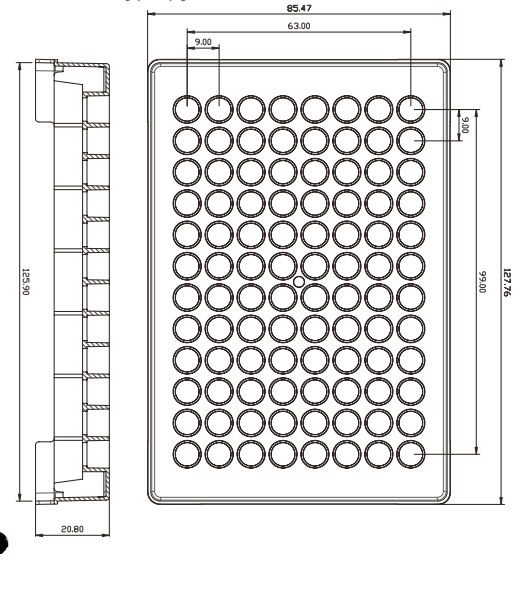

Format: 96-tip format
 Tip Volume range selection: 200µl
 Material: Virgin Polypropylene
 Alternatives:
 ○ With/without aerosol-barrier filter
 ○ Pre-Sterilized/Non-Sterilized
 ○ Low Retention/Standard
 Certified:
 DNase-Free, RNase-Free, Endotoxin-Safe

Material: Polypropylene















200µl

GEB Cat#	Max Volume	Tip Color	Packaging Specification	Carton Size L*W*H(mm)	Weight KGs
AT200R-B-N	200µl	Natural	1000 tips / bag, 20bags / case	595*325*310	3.2
 AT200R-B-N-LB	200µl	Natural Low Retention	1000 tips / bag, 20bags / case	595*325*310	3.2
AT200R-9-N	200µl	Natural	96 tips/rack, 10 racks/pack, 5 packs/case	480*345*280	7.8
 AT200R-9-N-LB	200µl	Natural Low Retention	96 tips/rack, 10 racks/pack, 5 packs/case	480*345*280	7.8
AT200R-9-NS	200µl	Natural Pre-Sterilized	96 tips/rack, 10 racks/pack, 5 packs/case	480*345*280	7.8
 AT200R-9-NS-LB	200µl	Natural Pre-Sterilized, Low Retention	96 tips/rack, 10 racks/pack, 5 packs/case	480*345*280	7.8
AF200R-9-NS	200µl	Natural Filtered, Pre-Sterilized	96 tips/rack, 10 racks/pack, 5 packs/case	480*345*280	7.8
 AF200R-9-NS-LB	200µl	Natural, Low Retention Filtered, Pre-Sterilized	96 tips/rack, 10 racks/pack, 5 packs/case	480*345*280	7.8

AT/AF200R-9

200µl

	GEB Cat#	Max Volume	Tip Color	Packaging Specification	Carton Size L*W*H(mm)	Weight KGs
 <p>AT/AF200R-R</p>	AT200R-R-N	200µl	Natural	96 tips/rack, 10 racks/pack, 5 packs/case	505*265*450	9.1
	 AT200R-R-N-LB	200µl	Natural Low Retention	96 tips/rack, 10 racks/pack, 5 packs/case	505*265*450	9.1
	AT200R-R-NS	200µl	Natural Pre-Sterilized	96 tips/rack, 10 racks/pack, 5 packs/case	505*265*450	9.1
	 AT200R-R-NS-LB	200µl	Natural Pre-Sterilized, Low Retention	96 tips/rack, 10 racks/pack, 5 packs/case	505*265*450	9.1
	AF200R-R-NS	200µl	Natural Filtered, Pre-Sterilized	96 tips/rack, 10 racks/pack, 5 packs/case	505*265*450	9.1
	 AF200R-R-NS-LB	200µl	Natural, Low Retention Filtered, Pre-Sterilized	96 tips/rack, 10 racks/pack, 5 packs/case	505*265*450	9.1
 <p>AT200R-E</p>	AF200R-B-N	200µl	Natural, Filtered	1000 tips / bag, 20bags / case	480*345*280	2.0
	 AF200R-B-N-LB	200µl	Natural Filtered, Low Retention	1000 tips / bag, 20bags / case	480*345*280	2.0
	AT200R-E-N	200µl	Natural	96 tips/rack, 10 racks/stacks, 5 stacks/case	455*270*265	6.3
 <p>AT/AF200RL-R</p>	 AT200R-E-N-LB	200µl	Natural Low Retention	96 tips/rack, 10 racks/stacks, 5 stacks/case	455*270*265	6.3
	AT200RL-B-N	200µl	Natural	1000 tips / bag, 20bags / case	690*235*330	5.3
	 AT200RL-B-N-LB	200µl	Natural Low Retention	1000 tips / bag, 20bags / case	690*235*330	5.3
	AT200RL-R-N	200µl	Natural	96 tips/rack, 10 racks/pack, 5 packs/case	495*285*650	13.5
	 AT200RL-R-N-LB	200µl	Natural Low Retention	96 tips/rack, 10 racks/pack, 5 packs/case	495*285*650	13.5
	AT200RL-R-NS	200µl	Natural Pre-Sterilized	96 tips/rack, 10 racks/pack, 5 packs/case	495*285*650	13.5
	 AT200RL-R-NS-LB	200µl	Natural Pre-Sterilized, Low Retention	96 tips/rack, 10 racks/pack, 5 packs/case	495*285*650	13.5
	AF200RL-R-NS	200µl	Natural Filtered, Pre-Sterilized	96 tips/rack, 10 racks/pack, 5 packs/case	495*285*650	13.5
	 AF200RL-R-NS-LB	200µl	Natural, Low Retention Filtered, Pre-Sterilized	96 tips/rack, 10 racks/pack, 5 packs/case	495*285*650	13.5
	AF200RL-B-N	200µl	Natural, Filtered	1000 tips / bag, 20bags / case	480*345*280	2.0
 AF200RL-B-N-LB	200µl	Natural Filtered, Low Retention	1000 tips / bag, 20bags / case	480*345*280	2.0	

TIPS

Compatible with
Rainin





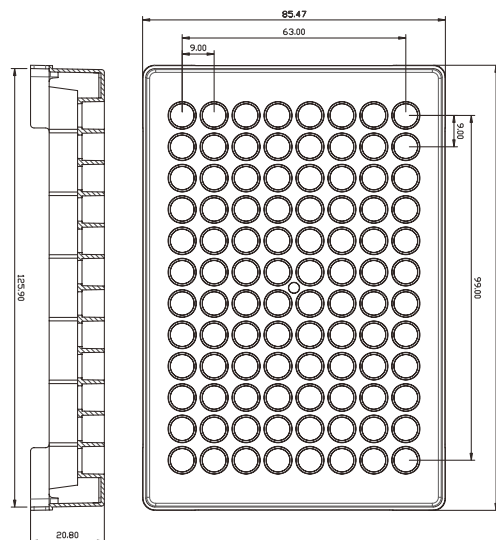
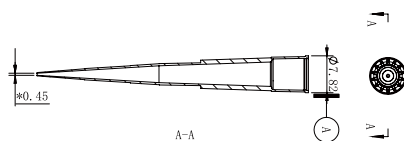
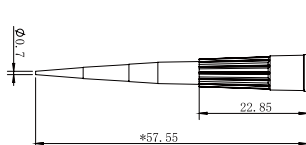

Format: 96-tip format
 Tip Volume range selection: 300µl
 Material: Virgin Polypropylene
 Alternatives:
 ● With/without aerosol-barrier filter
 ● Pre-Sterilized/Non-Sterilized
 ● Low Retention/Standard
 Certified:
 DNase-Free, RNase-Free, Endotoxin-Safe

Material: Polypropylene



300µl

GEB Cat#	Max Volume	Tip Color	Packaging Specification	Carton Size L*W*H(mm)	Weight KGs
AT300R-9-N	300µl	Natural	96 tips/rack, 10 racks/pack, 5 packs/case	480*345*280	8.0
 AT300R-9-N-LB	300µl	Natural Low Retention	96 tips/rack, 10 racks/pack, 5 packs/case	480*345*280	8.0
AT300R-9-NS	300µl	Natural Pre-Sterilized	96 tips/rack, 10 racks/pack, 5 packs/case	480*345*280	8.0
 AT300R-9-NS-LB	300µl	Natural Pre-Sterilized, Low Retention	96 tips/rack, 10 racks/pack, 5 packs/case	480*345*280	8.0
 AF300R-9-NS	300µl	Natural Filtered, Pre-Sterilized	96 tips/rack, 10 racks/pack, 5 packs/case	480*345*280	8.0
 AF300R-9-NS-LB	300µl	Natural, Low Retention Filtered, Pre-Sterilized	96 tips/rack, 10 racks/pack, 5 packs/case	480*345*280	8.0

TIPS

Compatible with
Rainin



Format: 96-tip format
 Tip Volume range selection: 1000µl
 Material: Virgin Polypropylene
 Alternatives:
 ● With/without aerosol-barrier filter
 ● Pre-Sterilized/Non-Sterilized
 ● Low Retention/Standard
 Certified:
 DNase-Free, RNase-Free, Endotoxin-Safe



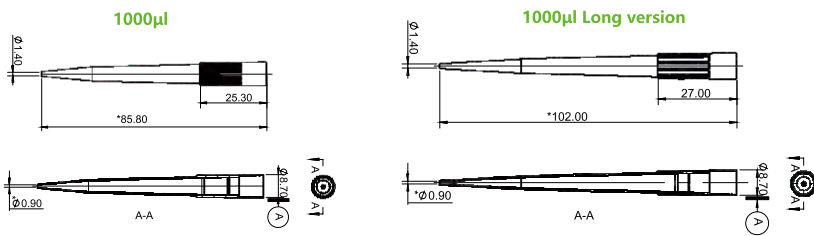
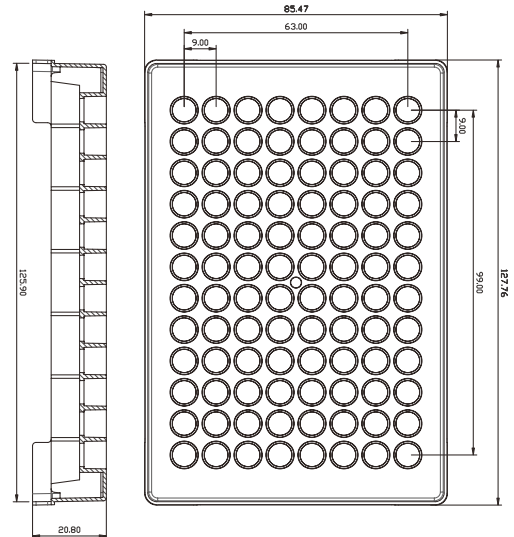











Material: Polypropylene



1000µl

	GEB Cat#	Max Volume	Tip Color	Packaging Specification	Carton Size L*W*H(mm)	Weight KGs	
	AT1000R-B-N	1000µl	Natural	1000 tips / bag, 5 bags / case	690*235*330	5.3	
	AT1000R-B-N-LB	1000µl	Natural Low Retention	1000 tips / bag, 5 bags / case	690*235*330	5.3	
	AT1000R-9-N	1000µl	Natural	96 tips/rack, 10 racks/pack, 5 packs/case	475*285*595	13.5	
	AT1000R-9-N-LB	1000µl	Natural Low Retention	96 tips/rack, 10 racks/pack, 5 packs/case	475*285*595	13.5	
	AT1000R-9-NS	1000µl	Natural Pre-Sterilized	96 tips/rack, 10 racks/pack, 5 packs/case	475*285*595	13.5	
	AT1000R-9-NS-LB	1000µl	Natural Pre-Sterilized, Low Retention	96 tips/rack, 10 racks/pack, 5 packs/case	475*285*595	13.5	
	AF1000R-9-NS	1000µl	Natural Filtered, Pre-Sterilized	96 tips/rack, 10 racks/pack, 5 packs/case	475*285*595	13.5	
	AT/AF1000R-9	AF1000R-9-NS-LB	1000µl	Natural, Low Retention Filtered, Pre-Sterilized	96 tips/rack, 10 racks/pack, 5 packs/case	475*285*595	13.5

1000µl

	GEB Cat#	Max Volume	Tip Color	Packaging Specification	Carton Size L*W*H(mm)	Weight KGs
 <p>AT/AF1000R-R</p>	AT1000R-R-N	1000µl	Natural	96 tips/rack, 10 racks/pack, 5 packs/case	475*285*595	13.5
	 AT1000R-R-N-LB	1000µl	Natural Low Retention	96 tips/rack, 10 racks/pack, 5 packs/case	475*285*595	13.5
	AT1000R-R-NS	1000µl	Natural Pre-Sterilized	96 tips/rack, 10 racks/pack, 5 packs/case	475*285*595	13.5
	 AT1000R-R-NS-LB	1000µl	Natural Pre-Sterilized, Low Retention	96 tips/rack, 10 racks/pack, 5 packs/case	475*285*595	13.5
	AF1000R-R-NS	1000µl	Natural Filtered, Pre-Sterilized	96 tips/rack, 10 racks/pack, 5 packs/case	475*285*595	13.5
	 AF1000R-R-NS-LB	1000µl	Natural, Low Retention Filtered, Pre-Sterilized	96 tips/rack, 10 racks/pack, 5 packs/case	475*285*595	13.5
 <p>AT1000R-E</p>	AF1000R-B-N	1000µl	Natural, Filtered	1000 tips per bag, 5bags per case	690*235*330	5.3
	 AF1000R-B-N-LB	1000µl	Natural Filtered, Low Retention	1000 tips per bag, 5bags per case	690*235*330	5.3
	AF1000R-B-NS	1000µl	Natural Filtered, Pre-Sterilized	1000 tips per bag, 5bags per case	690*235*330	5.3
	 AF1000R-B-NS-LB	1000µl	Natural, Low Retention Filtered, Pre-Sterilized	1000 tips per bag, 5bags per case	690*235*330	5.3
 <p>AT1000R-E</p>	AT1000R-E-N	1000µl	Natural	96 tips/rack, 5 racks/stacks, 10 stacks/case	455*270*265	7.2
	 AT1000R-E-N-LB	1000µl	Natural Low Retention	96 tips/rack, 5 racks/stacks, 10 stacks/case	455*270*265	7.2
 <p>AT/AF1000RL-R</p>	AT1000RL-B-N	1000µl	Natural	1000 tips / bag, 5 bags / case	690*235*330	5.3
	 AT1000RL-B-N-LB	1000µl	Natural Low Retention	1000 tips / bag, 5 bags / case	690*235*330	5.3
	AT1000RL-R-N	1000µl	Natural	96 tips/rack, 10 racks/pack, 5 packs/case	495*285*650	13.5
	 AT1000RL-R-N-LB	1000µl	Natural Low Retention	96 tips/rack, 10 racks/pack, 5 packs/case	495*285*650	13.5
	AT1000RL-R-NS	1000µl	Natural Pre-Sterilized	96 tips/rack, 10 racks/pack, 5 packs/case	495*285*650	13.5
	 AT1000RL-R-NS-LB	1000µl	Natural Pre-Sterilized, Low Retention	96 tips/rack, 10 racks/pack, 5 packs/case	495*285*650	13.5
	AF1000RL-R-NS	1000µl	Natural Filtered, Pre-Sterilized	96 tips/rack, 10 racks/pack, 5 packs/case	495*285*650	13.5
	 AF1000RL-R-NS-LB	1000µl	Natural, Low Retention Filtered, Pre-Sterilized	96 tips/rack, 10 racks/pack, 5 packs/case	495*285*650	13.5

GEB, Your Better Choice

Serological Pipette



Clear and bidirectional graduations on the pipette, negative graduation.
Allows additional working volume.
Our innovation guarantees your pipetting with improved accuracy and flexibility.



Color-coded packaging for sorting and selecting
Filter plug prevents overflow.
Certified: DNase-Free, RNase-Free, Endotoxin-Safe.

GEB produces pipette tips with exclusive techniques of TWC Thin Wall Crown and R&R Low Retention so that the cooperation between pipettor and tip is optimized.

The liquid handling will be more accurate and flexible with GEB pipette tips.



Serological Pipette



GEB Cat#	Type	Volume	Color code	Packaging	Packaging Specification
SEP01ML-B		1 ml	Yellow	Bulk	50pcs per bag, 10 bags per case
SEP01ML-B-S	Sterilized	1 ml	Yellow	Bulk	50pcs per bag, 10 bags per case
SEP02ML-B		2 ml	Green	Bulk	50pcs per bag, 10 bags per case
SEP02ML-B-S	Sterilized	2 ml	Green	Bulk	50pcs per bag, 10 bags per case
SEP05ML-B		5 ml	Blue	Bulk	50pcs per bag, 10 bags per case
SEP05ML-B-S	Sterilized	5 ml	Blue	Bulk	50pcs per bag, 10 bags per case
SEP10ML-B		10 ml	Orange	Bulk	50pcs per bag, 8 bags per case
SEP10ML-B-S	Sterilized	10 ml	Orange	Bulk	50pcs per bag, 8 bags per case
SEP25ML-B		25 ml	Red	Bulk	25pcs per bag, 8 bags per case
SEP25ML-B-S	Sterilized	25 ml	Red	Bulk	25pcs per bag, 8 bags per case
SEP50ML-B		50 ml	Purple	Bulk	25pcs per bag, 4 bags per case
SEP50ML-B-S	Sterilized	50 ml	Purple	Bulk	25pcs per bag, 4 bags per case

Tubes

Optimum Sample Handling

Optimum safelocker design, high quality virgin resin, R&R GEB retentionless recovery technique, etc., will help you to optimize your sample handling.

Proteomics.Drug R&D.Genomics.HTS



GEB **DUAL SNAPLOCK** system provides you double cap lock for micro centrifuge tubes with a safer leakproofness to protect your reaction systems or biological solutions.

DUAL SNAPLOCK system also creates a "half lock" status which provides a flexible position during your multiple reagents processing steps.

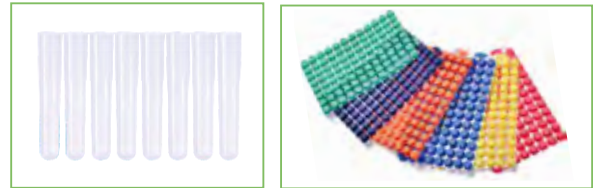

Unique O-ring integrated design ensures better protection for your reagents

Features:

- Glass-like transparent tubes are also available in seven additional colours.
- Snap-lock tubes are guaranteed to stay closed, even during boiling or autoclaving.
- Withstand up to 20,000 RCF.
- Snap-lock cap ensures efficient seal, yet is still easy to 'flip' open.
- Thin membrane in the caps centre allows easy piercing by syringe needle.
- Certified RNase, DNase, protease and endotoxin-free for total sample integrity.
- Apparent scale identification to facilitate control of liquid volume.

TUBES

GEB Microcentrifuge Tubes



0.6ml



GEB Cat#	Volume	Type	Packaging Specification	Carton Size L*W*H(mm)	Weight KGs
CT0050-B-N	0.6ml	Natural	1000 tubes per bag, 10 bags per case	730*250*345	12.5
 CT0050-B-N-LB	0.6ml	Natural Low Retention	1000 tubes per bag, 10 bags per case	730*250*345	12.5

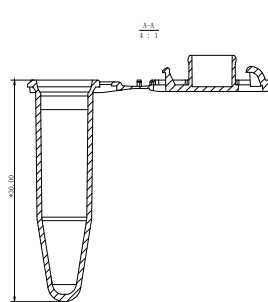
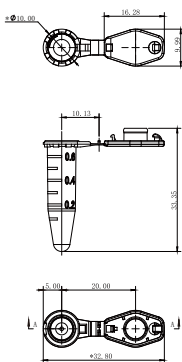

0.6ml

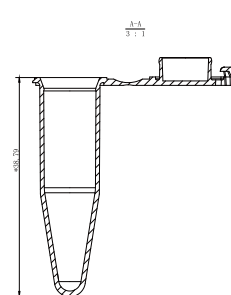
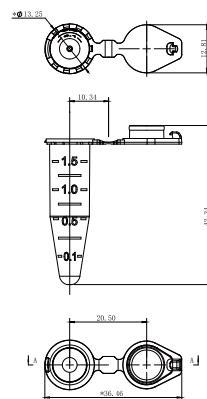

1.5ml

1.5ml



GEB Cat#	Volume	Type	Packaging Specification	Carton Size L*W*H(mm)	Weight KGs
CT0150-B-N	1.5 ml	Natural	500 tubes per bag, 10 bags per case	730*250*345	8.5
 CT0150-B-N-LB	1.5 ml	Natural Low Retention	500 tubes per bag, 10 bags per case	730*250*345	8.5



CT0150-B-B	1.5 ml	Blue	500 tubes per bag, 10 bags per case	730*250*345	8.5
 CT0150-B-B-LB	1.5 ml	Blue Low Retention	500 tubes per bag, 10 bags per case	730*250*345	8.5



CT0150-B-G	1.5 ml	Green	500 tubes per bag, 10 bags per case	730*250*345	8.5
 CT0150-B-G-LB	1.5 ml	Green Low Retention	500 tubes per bag, 10 bags per case	730*250*345	8.5



CT0150-B-O	1.5 ml	Orange	500 tubes per bag, 10 bags per case	730*250*345	8.5
 CT0150-B-O-LB	1.5 ml	Orange Low Retention	500 tubes per bag, 10 bags per case	730*250*345	8.5

TUBES

GEB Microcentrifuge Tubes



1.5ml

	GEB Cat#	Volume	Type	Packaging Specification	Carton Size L*W*H(mm)	Weight KGs
	CT0150-B-R	1.5 ml	Red	500 tubes per bag, 10 bags per case	730*250*345	8.5
	CT0150-B-R-LB	1.5 ml	Red Low Retention	500 tubes per bag, 10 bags per case	730*250*345	8.5
	CT0150-B-V	1.5 ml	Violet	500 tubes per bag, 10 bags per case	730*250*345	8.5
	CT0150-B-V-LB	1.5 ml	Violet Low Retention	500 tubes per bag, 10 bags per case	730*250*345	8.5
	CT0150-B-A	1.5 ml	Amber	500 tubes per bag, 10 bags per case	730*250*345	8.5
	CT0150-B-A-LB	1.5 ml	Amber Low Retention	500 tubes per bag, 10 bags per case	730*250*345	8.5
	CT0150-B-Y	1.5 ml	Yellow	500 tubes per bag, 10 bags per case	730*250*345	8.5
	CT0150-B-Y-LB	1.5 ml	Yellow Low Retention	500 tubes per bag, 10 bags per case	730*250*345	8.5

2.0ml

	GEB Cat#	Volume	Type	Packaging Specification	Carton Size L*W*H(mm)	Weight KGs
	CT0200-B-N	2.0ml	Natural	500 tubes per bag, 10 bags per case	730*250*345	11.2
	CT0200-B-N-LB	2.0ml	Natural Low Retention	500 tubes per bag, 10 bags per case	730*250*345	11.2

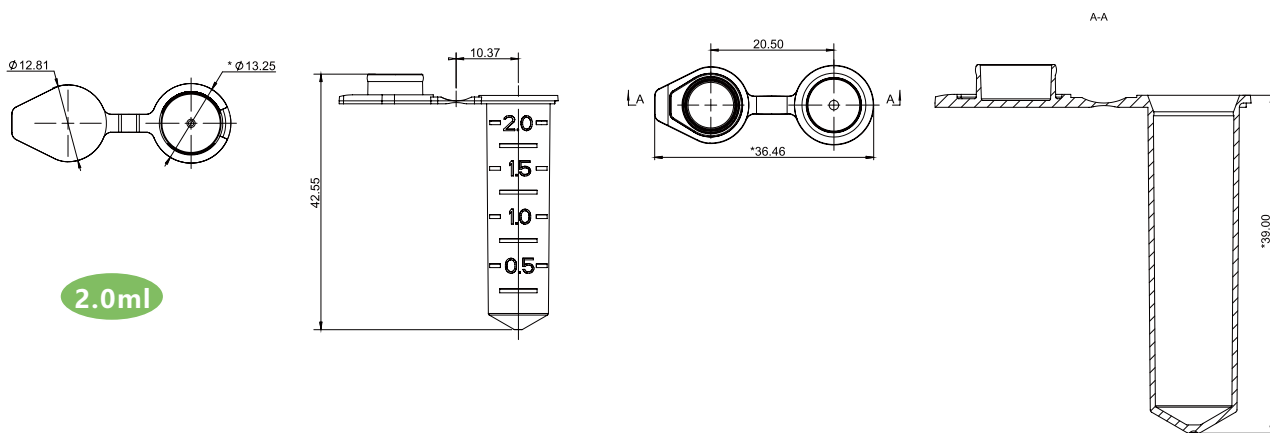

TUBES

GEB Microcentrifuge Tubes



5.0ml



GEB Cat#	Volume	Type	Color	Packaging Specification
CT005M-L-B-N	5ml	No Graduated	Natural	300 tubes per bag, 10 bags per case
 CT005M-L-G-B-N	5ml	Graduated	Natural	300 tubes per bag, 10 bags per case

7.0ml



GEB Cat#	Volume	Type	Color	Packaging Specification
CT007M-R-B-N	7ml	Round Bottom	Natural	200 tubes per bag, 10 bags per case

10ml



GEB Cat#	Volume	Type	Color	Packaging Specification
CT010M-R-B-N	10ml	Round Bottom	Natural	200 tubes per bag, 10 bags per case

15ml



GEB Cat#	Volume	Type	Color	Packaging Specification
CT015M-C-B-N	15ml	Conical Bottom	Natural	100 tubes per bag, 12 bags per case
CT015M-C-B-TS-B	15ml	Conical Bottom	Natural	100 tubes per bag, 12 bags per case

50ml



GEB Cat#	Volume	Type	Color	Packaging Specification
CT050M-R-B-N	50ml	Round Bottom	Natural	50 tubes per bag, 10 bags per case

TUBES

GEB Microcentrifuge Tubes



50ml



GEB Cat#	Volume	Type	Color	Packaging Specification
CT050M-SS-C-B-N	50ml	Conical Bottom Self-standing	Natural	40 tubes per bag, 10 bags per case
 CT050M-C-B-N	50ml	Conical Bottom	Natural	40 tubes per bag, 10 bags per case
CT050M-C-B-TS-B	50ml	Conical Bottom	Natural	40 tubes per bag, 10 bags per case

2D code tube



GEB Cat#	Volume	Color	Packaging Specification
2DT075-9-N	0.75ml	Natural	96 tubes per racks, 50 racks per case
2DT125-9-N	1.25ml	Natural	96 tubes per racks, 50 racks per case
2DT200-9-N	2.0ml	Natural	48 tubes per racks, 50 racks per case

TUBES

Screw Cap Tubes With Caps



Packaging Specification:
500 tubes per bag, 8 bags per case

Carton Size(L*W*H):
690*235*330mm

Weight:
15.6kg

	GEB Cat#	Volume	Description	Color
	SCT060-ST-N	0.6ml	Self-standing	Natural
	SCT060-ST-B	0.6ml	Self-standing	Blue
	SCT060-ST-G	0.6ml	Self-standing	Green
	SCT060-ST-O	0.6ml	Self-standing	Orange
	SCT060-ST-R	0.6ml	Self-standing	Red
	SCT060-ST-V	0.6ml	Self-standing	Violet
	SCT060-ST-A	0.6ml	Self-standing	Amber
	SCT060-ST-Y	0.6ml	Self-standing	Yellow
	SCT150-C-N	1.5ml	V-bottom	Natural
	SCT150-C-B	1.5ml	V-bottom	Blue
	SCT150-C-G	1.5ml	V-bottom	Green
	SCT150-C-O	1.5ml	V-bottom	Orange
	SCT150-C-R	1.5ml	V-bottom	Red
	SCT150-C-V	1.5ml	V-bottom	Violet
	SCT150-C-A	1.5ml	V-bottom	Amber
	SCT150-C-Y	1.5ml	V-bottom	Yellow
	SCT150-ST-N	1.5ml	Self-standing	Natural
	SCT150-ST-B	1.5ml	Self-standing	Blue
	SCT150-ST-G	1.5ml	Self-standing	Green
	SCT150-ST-O	1.5ml	Self-standing	Orange
	SCT150-ST-R	1.5ml	Self-standing	Red
	SCT150-ST-V	1.5ml	Self-standing	Violet
SCT150-ST-A	1.5ml	Self-standing	Amber	
SCT150-ST-Y	1.5ml	Self-standing	Yellow	
	SCT200-ST-N	2.0ml	Self-standing	Natural
	SCT200-ST-B	2.0ml	Self-standing	Blue
	SCT200-ST-G	2.0ml	Self-standing	Green
	SCT200-ST-O	2.0ml	Self-standing	Orange
	SCT200-ST-R	2.0ml	Self-standing	Red
	SCT200-ST-V	2.0ml	Self-standing	Violet
	SCT200-ST-A	2.0ml	Self-standing	Amber
	SCT200-ST-Y	2.0ml	Self-standing	Yellow

TUBES

GEB Sample Tubes



Individual Sample tubes

	GEB Cat#	Volume	Type	Packaging Specification
	TT1201-2-B-N	1.2 ml	Natural	1000 tubes per bag , 10 bags per case
	TT1201-2-B-N-LB	1.2 ml	Natural Low Retention	1000 tubes per bag , 10 bags per case
	TT1201-2-9-N	1.2 ml	Natural	96 tubes per rack 10 racks per pack , 5packs per case
	TT1201-2-9-N-LB	1.2 ml	Natural Low Retention	96 tubes per rack 10 racks per pack , 5packs per case
	TT1201-2-9-NS	1.2 ml	Natural Pre-Sterilized	96 tubes per rack 10 racks per pack , 5packs per case
	TT1201-2-9-NS-LB	1.2 ml	Natural Low Retention,Pre-Sterilized	96 tubes per rack 10 racks per pack , 5packs per case

8 Strip Sample tubes

	GEB Cat#	Volume	Type	Packaging Specification
	TT1208-B-N	1.2 ml	Natural	125 Strips per bag, 10 bags per case
	TT1208-B-N-LB	1.2 ml	Natural Low Retention	125 Strips per bag, 10 bags per case
	TT1208-9-N	1.2 ml	Natural	12 Strips per rack 5 packs per case , 10 racks per pack
	TT1208-9-N-LB	1.2 ml	Natural Low Retention	12 Strips per rack 5 packs per case , 10 racks per pack
	TT1208-9-NS	1.2 ml	Natural Pre-Sterilized	12 Strips per rack 5 packs per case , 10 racks per pack
	TT1208-9-NS-LB	1.2 ml	Natural Low Retention,Pre-Sterilized	12 Strips per rack 5 packs per case , 10 racks per pack

Seal Mats for Sample tubes (TT1201 & TT1208)

	GEB Cat#	Type	Packaging	Packaging Specification
	TTOMAT-08-N	Natural	Bulk	125 Strips per bag , 5 bags per case
	TTOMAT-9-N	Natural	Bulk	10 mats per bag , 5 bags per case

Silicone Sealing Mats



For 1.3ml Round deep well plate & GEB sample tube

	GEB Cat#	Color	Packaging Specification	Carton Size L*W*H(mm)	Weight KGs
	CSMATR-9-R	Red	10 mats per bag, 5 bags per case	465*155*135	1.18
	CSMATR-9-Y	Yellow	10 mats per bag, 5 bags per case	465*155*135	1.18
	CSMATR-9-O	Orange	10 mats per bag, 5 bags per case	465*155*135	1.18
	CSMATR-9-G	Green	10 mats per bag, 5 bags per case	465*155*135	1.18
	CSMATR-9-B	Blue	10 mats per bag, 5 bags per case	465*155*135	1.18
	CSMATR-9-V	Violet	10 mats per bag, 5 bags per case	465*155*135	1.18

Reagent bottle



wide bore round bottom reagent bottle

	GEB Cat#	Volume	Type	Color	Packaging Specification
	SJPG08-B-N	8ml	Wide bore round bottom	Natural	150 pcs per bag, 10 bags per case
	SJPG15-B-N	15ml	Wide bore round bottom	Natural	120 pcs per bag, 10 bags per case
	SJPG30-B-N	30ml	Wide bore round bottom	Natural	100 pcs per bag, 10 bags per case
	SJPG60-B-N	60ml	Wide bore round bottom	Natural	100 pcs per bag, 10 bags per case
	SJPG125-B-N	125ml	Wide bore round bottom	Natural	50 pcs per bag, 10 bags per case
	SJPG250-B-N	250ml	Wide bore round bottom	Natural	25 pcs per bag, 10 bags per case
	SJPG500-B-N	500ml	Wide bore round bottom	Natural	12 pcs per bag, 10 bags per case

Sponge Swab

FOR ORAL FLUID AND CELL COLLECTION SYSTEM

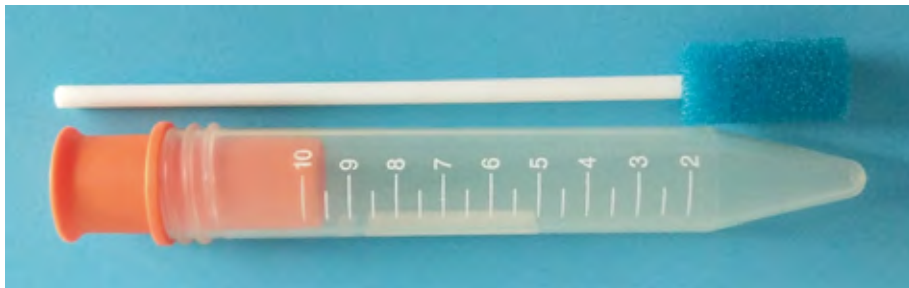

This sponge swab is designed to collect oral fluid and cells. The swab is used like a toothbrush. Firstly open the package and remove the tube.



Oral fluid or cells are collected by rubbing the sponge firmly along the gum (at the base of the teeth if present) until the sponge swab is wet. It takes about one minute.



Replace the swab in the tube and close the cap. Return sample to the laboratory for processing

This product can do not need to use the centrifuge and can recycle oral liquid and cells, operation is as follows



Place the swab upside down in the tube



Close the cap, the cap can squeeze liquid

Liquid recovery can be achieved >93%

GEB, Your Better Choice

Reservoirs

Optimum sample collection and storage

GEB exclusive R&R Low Retention technique provides Reservoirs with the optimum sample and reagent saving effect

High Throughput Screening(HTS)•Samples & reagents storage



GEB R&R Low Retention Technique

GEB's **R&R** liquid reservoirs provide you a maximum saving effect for biological solutions including samples and reagents to guarantee accurate and repeatable results.

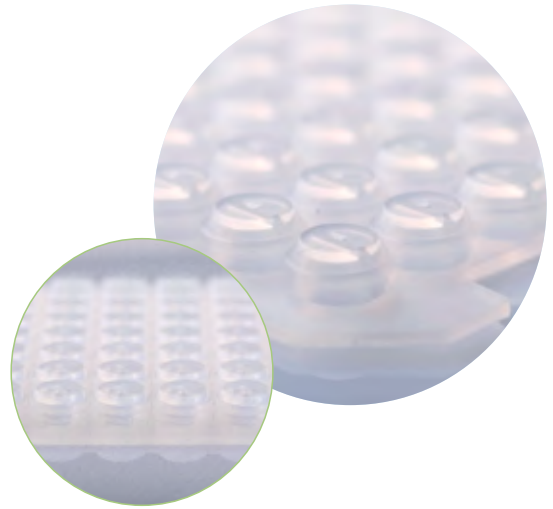

O-ring

Special designing of O ring which optimizes leakproofness and makes closing and opening more easily.



Features:

- Polypropylene can be autoclavable at 121°C and it is also long-term stable at -80°C.
- U-shaped and V-shaped bottom outlet series most suitable for mixing and collection of samples.
- Alphabetical sorting and cut angle mark for convenient tracking of samples.
- Applicable to multi-channel pipettors and automation systems.



Minimize sample and reagent retention
Guarantee reaction system accuracy and precision

Deep Well Plates

96 Round Well Series



330µl Deep-well plate, Round well-V bottom
Made of virgin polypropylene



Packaging Specification:
10 plates per bag, 10 bags per case

Carton Size(L*W*H):
440*275*150mm

Weight:
5.0kg

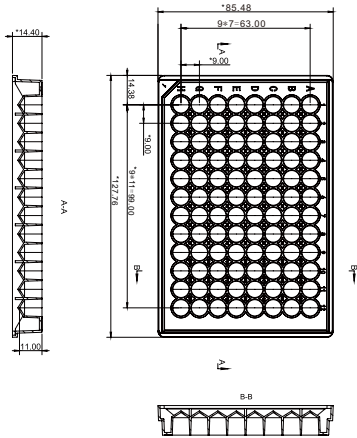

GEB Cat#	Working Volume	Type	Color
DP33VR-9-N	330µl		Natural
DP33VR-9-N-LB	330µl	Low Retention	Natural
DP33VR-9-NS	330µl	Pre-Sterilized	Natural
DP33VR-9-NS-LB	330µl	Low Retention,Pre-Sterilized	Natural
DP33VR-9-B	330µl		Blue
DP33VR-9-B-LB	330µl	Low Retention	Blue
DP33VR-9-BS	330µl	Pre-Sterilized	Blue
DP33VR-9-BS-LB	330µl	Low Retention,Pre-Sterilized	Blue
DP33VR-9-R	330µl		Red
DP33VR-9-R-LB	330µl	Low Retention	Red
DP33VR-9-RS	330µl	Pre-Sterilized	Red
DP33VR-9-RS-LB	330µl	Low Retention,Pre-Sterilized	Red

350µl Deep-well plate, Round well-U bottom
Made of virgin polypropylene



Packaging Specification:
10 plates per bag, 10 bags per case

Carton Size(L*W*H):
440*275*150mm

Weight:
5.0kg

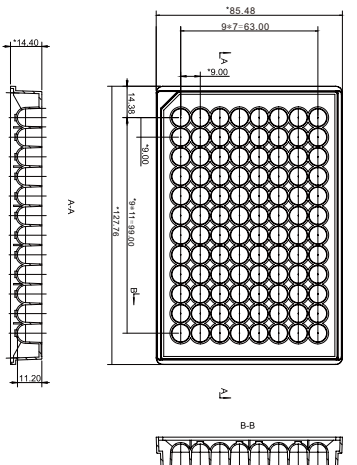

GEB Cat#	Working Volume	Type	Color
DP35UR-9-N	350µl		Natural
DP35UR-9-N-LB	350µl	Low Retention	Natural
DP35UR-9-NS	350µl	Pre-Sterilized	Natural
DP35UR-9-NS-LB	350µl	Low Retention,Pre-Sterilized	Natural
DP35UR-9-B	350µl		Blue
DP35UR-9-B-LB	350µl	Low Retention	Blue
DP35UR-9-BS	350µl	Pre-Sterilized	Blue
DP35UR-9-BS-LB	350µl	Low Retention,Pre-Sterilized	Blue
DP35UR-9-R	350µl		Red
DP35UR-9-R-LB	350µl	Low Retention	Red
DP35UR-9-RS	350µl	Pre-Sterilized	Red
DP35UR-9-RS-LB	350µl	Low Retention,Pre-Sterilized	Red

Deep Well Plates

96 Round Well Series

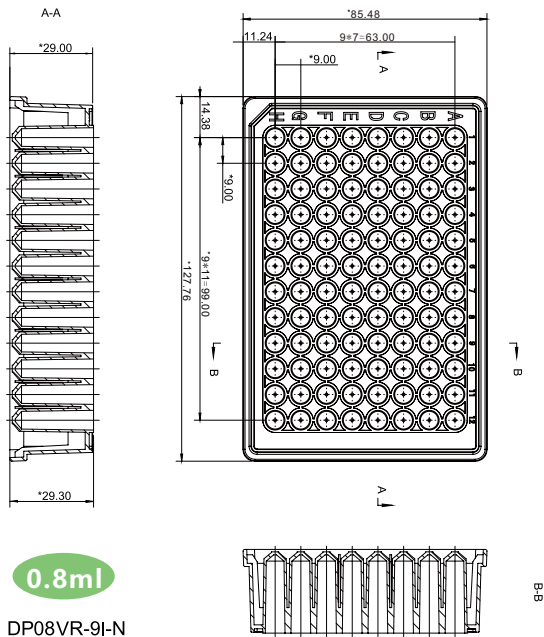

0.8ml

DP08VR-9I-N

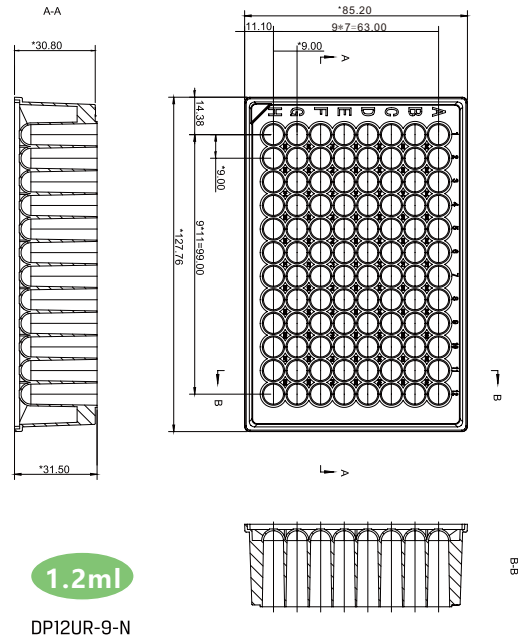



1.2ml

DP12UR-9-N



0.8ml Deep-well plate, Round well-V bottom

Made of virgin polypropylene

	GEB Cat#	Volume	Type	Packaging Specification	Carton Size L*W*H(mm)	Weight KGs
	DP08VR-9I-N	0.8ml	Natural	5 plates per bag, 10 bags per case	450*270*190	4.4
	 DP08VR-9I-N-LB	0.8ml	Natural Low Retention	5 plates per bag, 10 bags per case	450*270*190	4.4
	DP08VR-9I-NS	0.8ml	Natural Pre-Sterilized	5 plates per bag, 10 bags per case	450*270*190	4.4
	 DP08VR-9I-NS-LB	0.8ml	Natural Low Retention, Pre-Sterilized	5 plates per bag, 10 bags per case	450*270*190	4.4

1.2ml Deep-well plate, Round well-U bottom

Made of virgin polypropylene

	GEB Cat#	Volume	Type	Packaging Specification	Carton Size L*W*H(mm)	Weight KGs
	DP12UR-9-N	1.2ml	Natural	5 plates per bag, 10 bags per case	450*270*190	4.5
	 DP12UR-9-N-LB	1.2ml	Natural Low Retention	5 plates per bag, 10 bags per case	450*270*190	4.5
	DP12UR-9-NS	1.2ml	Natural Pre-Sterilized	5 plates per bag, 10 bags per case	450*270*190	4.5
	 DP12UR-9-NS-LB	1.2ml	Natural Low Retention, Pre-Sterilized	5 plates per bag, 10 bags per case	450*270*190	4.5

Deep Well Plates

96 Round Well Series

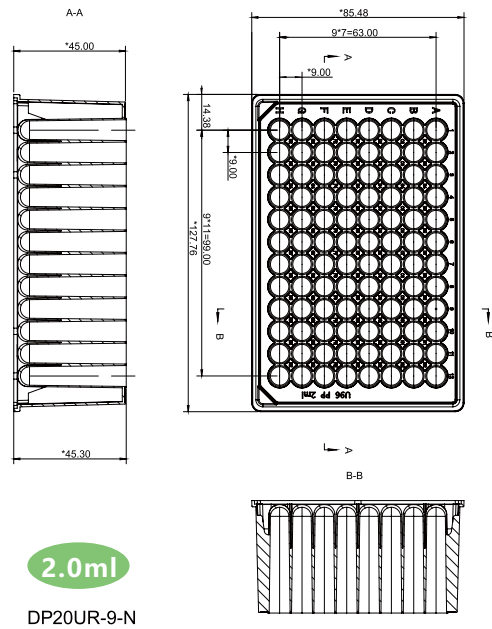
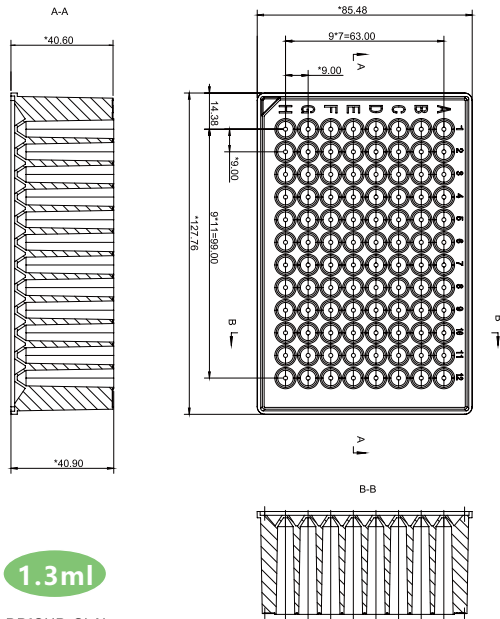

1.3ml Deep-well plate, Round well-U bottom

Made of virgin polypropylene

	GEB Cat#	Volume	Type	Packaging Specification	Carton Size L*W*H(mm)	Weight KGs
	DP13UR-9I-N	1.3ml	Natural	5 plates per bag, 10 bags per case	440*270*240	6.7
	DP13UR-9I-N-LB	1.3ml	Natural Low Retention	5 plates per bag, 10 bags per case	440*270*240	6.7
	DP13UR-9I-NS	1.3ml	Natural Pre-Sterilized	5 plates per bag, 10 bags per case	440*270*240	6.7
	DP13UR-9I-NS-LB	1.3ml	Natural Low Retention, Pre-Sterilized	5 plates per bag, 10 bags per case	440*270*240	6.7

2.0ml Deep-well plate, Round well-U bottom

Made of virgin polypropylene

	GEB Cat#	Volume	Type	Packaging Specification	Carton Size L*W*H(mm)	Weight KGs
	DP20UR-9-N	2.0ml	Natural	5 plates per bag, 10 bags per case	440*270*240	6.8
	DP20UR-9-N-LB	2.0ml	Natural Low Retention	5 plates per bag, 10 bags per case	440*270*240	6.8
	DP20UR-9-NS	2.0ml	Natural Pre-Sterilized	5 plates per bag, 10 bags per case	440*270*240	6.8
	DP20UR-9-NS-LB	2.0ml	Natural Low Retention, Pre-Sterilized	5 plates per bag, 10 bags per case	440*270*240	6.8

Deep Well Plates

96 Square Well Series

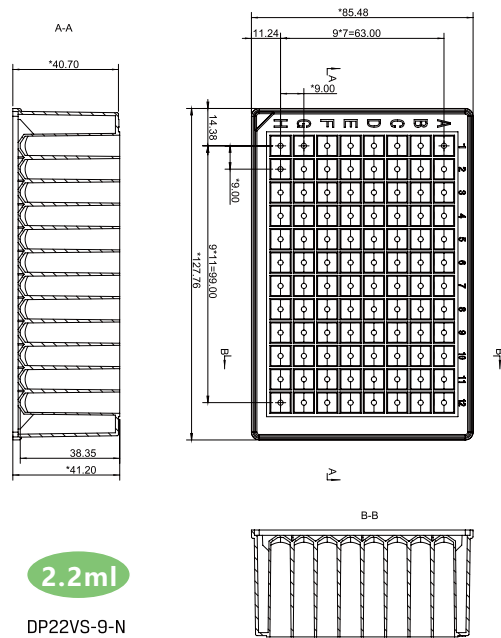
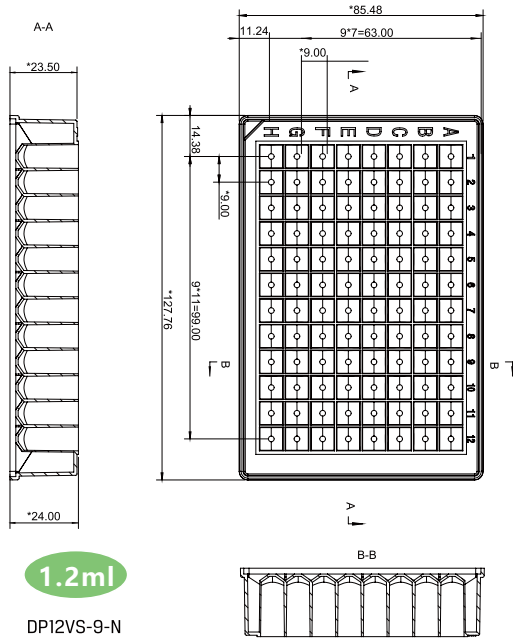

1.2ml Deep-well plate, square well-V bottom

Made of virgin polypropylene

	GEB Cat#	Volume	Type	Packaging Specification	Carton Size L*W*H(mm)	Weight KGs
	DP12VS-9-N	1.2ml	Natural	10 plates per bag, 10 bags per case	440*270*240	7.2
	DP12VS-9-N-LB	1.2ml	Natural Low Retention	10 plates per bag, 10 bags per case	440*270*240	7.2
	DP12VS-9-NS	1.2ml	Natural Pre-Sterilized	10 plates per bag, 10 bags per case	440*270*240	7.2
	DP12VS-9-NS-LB	1.2ml	Natural Low Retention, Pre-Sterilized	10 plates per bag, 10 bags per case	440*270*240	7.2

2.2ml Deep-well plate, square well-V bottom

Made of virgin polypropylene

	GEB Cat#	Volume	Type	Packaging Specification	Carton Size L*W*H(mm)	Weight KGs
	DP22VS-9-N	2.2ml	Natural	5 plates per bag, 10 bags per case	440*270*240	7.5
	DP22VS-9-N-LB	2.2ml	Natural Low Retention	5 plates per bag, 10 bags per case	440*270*240	7.5
	DP22VS-9-NS	2.2ml	Natural Pre-Sterilized	5 plates per bag, 10 bags per case	440*270*240	7.5
	DP22VS-9-NS-LB	2.2ml	Natural Low Retention, Pre-Sterilized	5 plates per bag, 10 bags per case	440*270*240	7.5

Deep Well Plates

96 Square Well Series

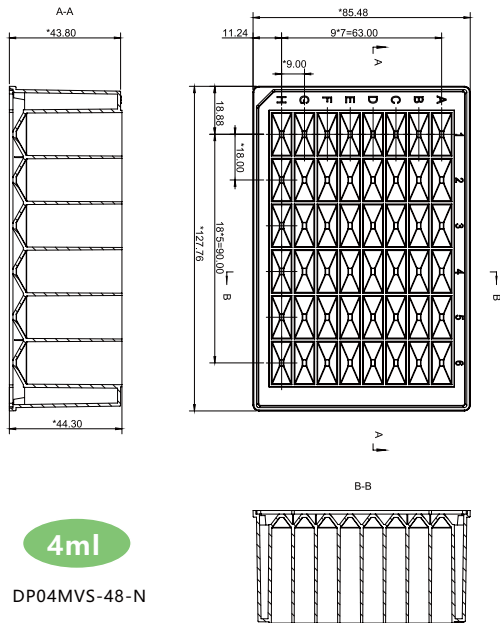

4ml

DP04MVS-48-N

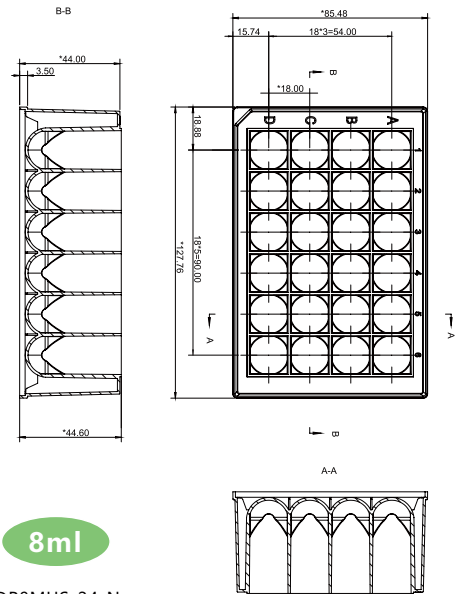

8ml

DP8MUS-24-N

4ml 48-well plate, square well-V bottom

Made of virgin polypropylene



GEB Cat#	Volume	Type	Packaging Specification	Carton Size L*W*H(mm)	Weight KGs
DP4MVS-48-N	4ml	Natural	5 plates per bag, 10 bags per case	440*270*240	9.04
 DP4MVS-48-NS	4ml	Natural Pre-Sterilized	5 plates per bag, 10 bags per case	440*270*240	9.04

8ml 24-well plate, square well-U bottom

Made of virgin polypropylene



GEB Cat#	Volume	Type	Packaging Specification	Carton Size L*W*H(mm)	Weight KGs
DP8MUS-24-N	8ml	Natural	5 plates per bag, 10 bags per case	440*270*240	9.04
 DP8MUS-24-NS	8ml	Natural Pre-Sterilized	5 plates per bag, 10 bags per case	440*270*240	9.04

Sealing mat fit 96 Square well series

Made of virgin Thermoplastic polypropylene



GEB Cat#	Type	Description	Packaging Specification	Carton Size L*W*H(mm)	Weight KGs
DPMS-9-W+	Natural	"+" Hole	10 mats per bag, 5 bags per case	465*155*135	1.80
DPMS-9-WS+	Natural, Pre-Sterilized	"+" Hole	10 mats per bag, 5 bags per case	465*155*135	1.80
DPMS-9-IMP-W+	Natural, Chemically Resistant	"+" Hole	10 mats per bag, 5 bags per case	465*155*135	1.80
DPMS-9-IMP-WS+	Natural, Pre-Sterilized Chemically Resistant	"+" Hole	10 mats per bag, 5 bags per case	465*155*135	1.80

Deep Well Plates

384 Square Well Series

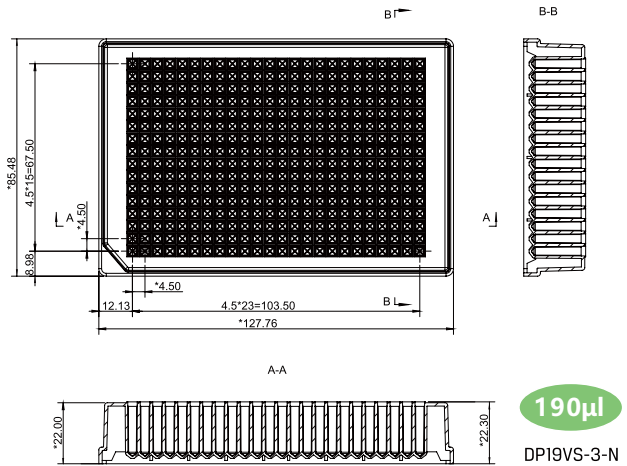
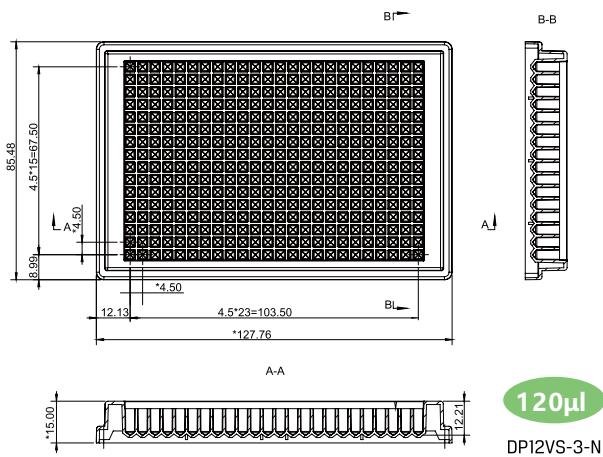

120µl Deep-well plate, square well-V bottom

Made of virgin polypropylene

	GEB Cat#	Volume	Type	Packaging Specification	Carton Size L*W*H(mm)	Weight KGs
	DPI2VS-3-N	120µl	Natural	10 plates per bag, 10 bags per case	450*270*190	4.8
	DPI2VS-3-N-LB	120µl	Natural Low Retention	10 plates per bag, 10 bags per case	450*270*190	4.8
	DPI2VS-3-NS	120µl	Natural Pre-Sterilized	10 plates per bag, 10 bags per case	450*270*190	4.8
	DPI2VS-3-NS-LB	120µl	Natural Low Retention,Pre-Sterilized	10 plates per bag, 10 bags per case	450*270*190	4.8

190µl Deep-well plate, square well-V bottom

Made of virgin polypropylene

	GEB Cat#	Volume	Type	Packaging Specification	Carton Size L*W*H(mm)	Weight KGs
	DPI9VS-3-N	190µl	Natural	10 plates per bag, 10 bags per case	440*270*240	4.8
	DPI9VS-3-N-LB	190µl	Natural Low Retention	10 plates per bag, 10 bags per case	440*270*240	4.8
	DPI9VS-3-NS	190µl	Natural Pre-Sterilized	10 plates per bag, 10 bags per case	440*270*240	4.8
	DPI9VS-3-NS-LB	190µl	Natural Low Retention,Pre-Sterilized	10 plates per bag, 10 bags per case	440*270*240	4.8

Sealing mat fit 384 Square well plate series

Made of virgin Thermoplastic polyurethane

	GEB Cat#	Type	Description	Packaging Specification	Carton Size L*W*H(mm)	Weight KGs
	DPMS-3-W+	Natural	"+" Hole	10 mats per bag, 5 bags per case	465*155*135	1.43
	DPMS-3-WS+	Natural,Pre-Sterilized	"+" Hole	10 mats per bag, 5 bags per case	465*155*135	1.43
	DPMS-3-IMP-W+	Natural,Chemically Resistant	"+" Hole	10 mats per bag, 5 bags per case	465*155*135	1.43
	DPMS-3-IMP-WS+	Natural, Pre-Sterilized Chemically Resistant	"+" Hole	10 mats per bag, 5 bags per case	465*155*135	1.43

You may also be interested in:

Lid fit 96/384 Deep-well plate

Packaging Specification:
10 plates per bag, 10 bags per case



GEB Cat#	Type	Color	Product Description	Packaging
DPOLID-3-N		Natural	fit 96/384 Deep	Bulk
DPOLID-3-NS	Pre-Sterilized	Natural	fit 96/384 Deep	Bulk

Sealing Mats

Optimum Leakproofness

Drug discovery • Molecular biology • Cell biology

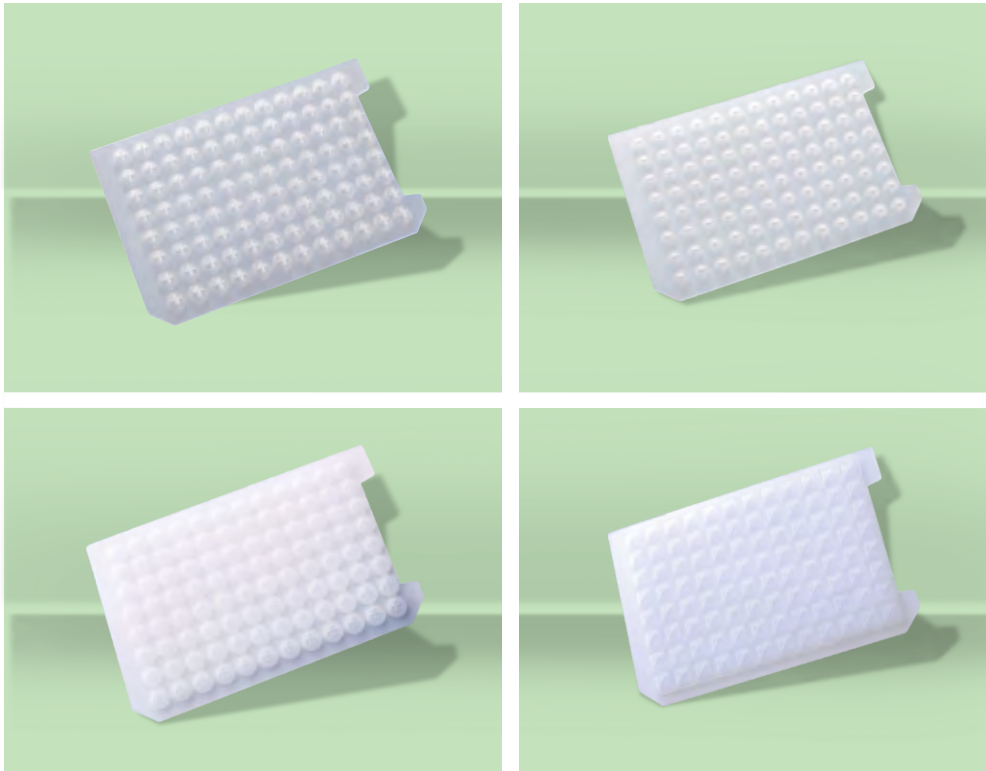

Exclusive Designed Oring

GEB Seal Mats for Deep Well Plates & Sample Tubes have an exclusive O ring structure, which makes GEB Seal Mat seal a plate more easily with a perfect sealing effect.

Features:

- The most complete line of sealing products in the industry, for the most choices.
- EasyPress and MiniSealer offer easier-operating and time-consuming options.
- A wide range of ImpermaMats offer unsurpassed protection for Volatile solvents.
- Films and mats can be used in a wide temperature range, they are suitable for most applications.
- Chemically resistant, pierceable thermoplastic elastomer well caps are excellent for storage to -80°C.
- Silicone pre-slit well caps permit a pipette tip or probe to enter the well without damage to the cap.
- Ethylene-vinyl acetate cap mats effectively seal polystyrene DeepWell™ plates.

Silicone Sealing Mats

Sealing Mats



For Sample tubes

Sealing Mat fits GEB Sample tubes



GEB Cat#	Color	Type	Description	Packaging Specification
TTOMAT-9-N	Natural	Common	Non-Sterilized	10 mats per bag, 5 bags per case

For PCR microplates

96 well PCR Sealing Mats



Carton Size:465*155*135mm Weight:1.54kg



GEB Cat#	Color	Type	Description	Packaging Specification
PCOMAT-9-W-	white	Common	"+" Hole, fits 96 PCR Plate, $\Phi=5.6$	10 mats per bag, 5 bags per case
PCOMAT-9-WS-	white	Pre-Sterilized	"+" Hole, fits 96 PCR Plate, $\Phi=5.6$	10 mats per bag, 5 bags per case
PCOMAT-9-IMP-W-	white	Chemically Resistant	"+" Hole, fits 96 PCR Plate, $\Phi=5.6$	10 mats per bag, 5 bags per case
PCOMAT-9-IMP-WS-	white	Pre-Sterilized Chemically Resistant	"+" Hole, fits 96 PCR Plate, $\Phi=5.6$	10 mats per bag, 5 bags per case

Compatible Sealing Mats

384 well PCR Sealing Mats



Carton Size:465*155*135mm Weight:1.43kg



GEB Cat#	Color	Type	Description	Packaging Specification
DPMR-3-W+	Natural	Common	"+" Hole, fits 384PCR Plate	10 mats per bag, 5 bags per case
DPMR-3-WS+	Natural	Pre-Sterilized	"+" Hole, fits 384PCR Plate	10 mats per bag, 5 bags per case
DPMR-3-IMP-W+	Natural	Chemically Resistant	"+" Hole, fits 384PCR Plate	10 mats per bag, 5 bags per case
DPMR-3-IMP-WS+	Natural	Pre-Sterilized Chemically Resistant	"+" Hole, fits 384PCR Plate	10 mats per bag, 5 bags per case

96-well Sealing Mats for Round Well



Carton Size:465*155*135mm Weight:1.80kg



GEB Cat#	Color	Type	Description	Packaging Specification
DPMR-9-W-	Natural	Common	"+" Hole, $\Phi=7.3$	10 mats per bag, 5 bags per case
DPMR-9-WS-	Natural	Pre-Sterilized	"+" Hole, $\Phi=7.3$	10 mats per bag, 5 bags per case
DPMR-9-IMP-W-	Natural	Chemically Resistant	"+" Hole, $\Phi=7.3$	10 mats per bag, 5 bags per case
DPMR-9-IMP-WS-	Natural	Pre-Sterilized Chemically Resistant	"+" Hole, $\Phi=7.3$	10 mats per bag, 5 bags per case

Fit DP13UR-9I-N/ Fit DP08VR-9I-N

Silicone Sealing Mats

Sealing Mats



96-well Sealing Mats for Round Well plates



Carton Size:465*155*135mm Weight:1.80kg

GEB Cat#	Color	Type	Description	Packaging Specification
DPMR-9-W+	Natural	Common	"+" Hole, Φ=8.3	10 mats per bag, 5 bags per case
DPMR-9-WS+	Natural	Pre-Sterilized	"+" Hole, Φ=8.3	10 mats per bag, 5 bags per case
DPMR-9-IMP-W+	Natural	Chemically Resistant	"+" Hole, Φ=8.3	10 mats per bag, 5 bags per case
DPMR-9-IMP-WS+	Natural	Pre-Sterilized Chemically Resistant	"+" Hole, Φ=8.3	10 mats per bag, 5 bags per case



Fit DP12UR-9-N/DP20UR-9-N

96-well Sealing Mats for Square Well plates



Carton Size:465*155*135mm Weight:1.80kg

GEB Cat#	Color	Type	Description	Packaging Specification
DPMS-9-W+	Natural	Common	"+" Hole	10 mats per bag, 5 bags per case
DPMS-9-WS+	Natural	Pre-Sterilized	"+" Hole	10 mats per bag, 5 bags per case
DPMS-9-IMP-W+	Natural	Chemically Resistant	"+" Hole	10 mats per bag, 5 bags per case
DPMS-9-IMP-WS+	Natural	Pre-Sterilized Chemically Resistant	"+" Hole	10 mats per bag, 5 bags per case



Fit DP12VS-9-N/DP22VS-9-N

384-well Sealing Mats for Square Well plates



Carton Size:465*155*135mm Weight:1.80kg

GEB Cat#	Color	Type	Description	Packaging Specification
DPMS-3-W+	Natural	Common	"+" Hole, Φ=7.3	10 mats per bag, 5 bags per case
DPMS-3-WS+	Natural	Pre-Sterilized	"+" Hole, Φ=7.3	10 mats per bag, 5 bags per case
DPMS-3-IMP-W+	Natural	Chemically Resistant	"+" Hole, Φ=7.3	10 mats per bag, 5 bags per case
DPMS-3-IMP-WS+	Natural	Pre-Sterilized Chemically Resistant	"+" Hole, Φ=7.3	10 mats per bag, 5 bags per case



Fit DP12VS-3-N/DP19VS-3-N



Shanghai Gene Era Bio-Science Co.,Ltd.

No.211 Huancheng East Road, Fengxian District, Shanghai

TEL:4008886799

EMAIL: market@ge-bio.com

WEB: www.ge-bio.com

