



Quality Laboratory Consumables

## Blue GEB, Your Better Choice

### Innovative Labware for Optimized Liquid-handling

- Precise & Accurate Liquid Pipetting
- Minimized Liquid Retention
- Maximized Compatibility & Flexibility



# 2014/2015

- **Robotic Tips**  
For Optimizing the Performance of Robotic Systems
  - *Thin Wall Crown Robotic Tips*
  - *Low Retention Robotic Tips*
  - *Dual Resin Robotic Tips*
- **PCR Series**  
For Optimizing PCR Precision And Minimizing Aerosol Contamination
  - *Dual Resin PCR Tubes and Caps*
  - *Low Retention PCR Tubes*
- **Universal Fit Pipette Tips**  
For Optimizing Pipetting Precision
  - *Thin Wall Crown Pipette Tips*
  - *Low Retention Pipette Tip*
- **Tubes**  
Super Leakproofness
  - *Dual snaplock Microtubes*
  - *Dual Resin Screw Cap Tubes*
- **Reservoirs**  
High Performance of liquid Reservoiring
  - *Low retention Liquid Reservoirs*
- **Sealing Mats**  
Excellent Seal Effects
  - *O ring Heads Sealing Mats*
  - *Dual Resin PCR Caps*

# LABORATORY CONSUMABLES



# Gene Era Biotech, Ltd.

## Global Leading Manufacturer and Supplier for Both Laboratory and Clinical Diagnostics

Since its inception, GEB has committed to manufacture and supply superior laboratory consumables to our customers.

All our products are designed by experienced engineers, and produced in the dust-free clean facility under strict manufacturing processes with premium materials. Before delivering to our customers, all products are accessed by a stringent QC process certified by ISO 9001:2008, ISO13485:2003, and ISO14001:2004, to assure the highest quality. We guarantee that all products are DNase/RNase, and pyrogen-free to meet the highest standard of both laboratory experiment and clinical diagnostics.

Through the enduring efforts in the past few years, GEB has grown to become one of the global leading manufacturers and suppliers of consumables for laboratory and clinical diagnostics. We will continually assure our customers with best products and services.

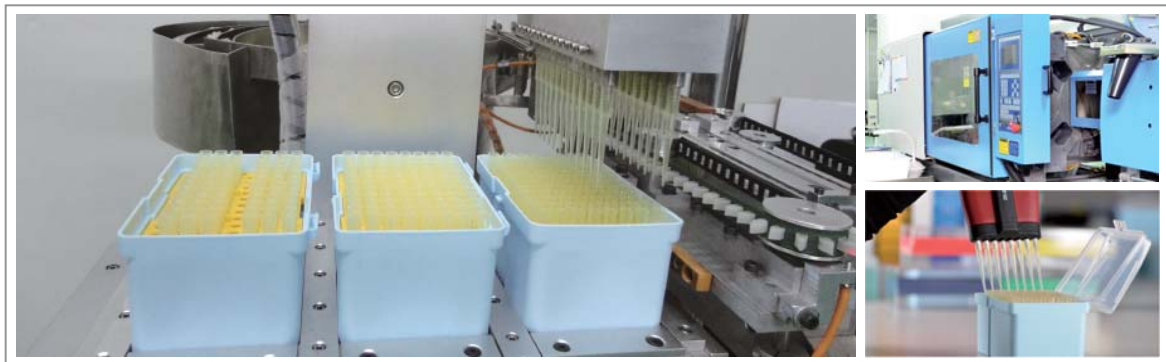

## Table of Contents

<b>Robotic Tips</b>	<b>01-33</b>
Agilent / Agilent Bravo	02-03
Beckman FX / NX, Multimek AP96 and Biomek 3000	04-07
Hamilton Star, Starlet and Nimbus	08-13
Tecan Genesis Freedom   Freedom Evo®   Miniprep with LiHa	14-19
Tecan Mca	20-21
Janus®   MultiProbe	22-25
Olympus	26-27
Rainin	28
Zymark®, Zymark Rapidplate/Sciclone	29-30
Cybi®, CyBi®-Well Family, Cybi®-Well; Cybi®-Well Vario; Cybi®-WellFlex; Cybi®-WellFlex Vario	31-32
HITACHI	33
<b>PCR Series</b>	<b>34-38</b>
<b>Universal Fit Pippete Tips</b>	<b>39-44</b>
<b>Tubes</b>	<b>45-52</b>
<b>Reservoirs</b>	<b>53-57</b>
<b>Sealing Mats</b>	<b>58-61</b>

## GEB's Solution

### GEB's SOLUTION for Micro-volume Liquid Handling

Micro-volume liquid handling is a critical issue in terms of laboratory accuracy and precision.

Less than 0.5  $\mu$ l of biologic solution is difficult to transfer accurately due to:

- Surface retention by tips, tubes, or reservoirs.
- Hanging drops and need for touch-off at the distal end of a tip with standard bore.

GEB's series innovation provides you a complete solution for handling a micro-volume biological solution.

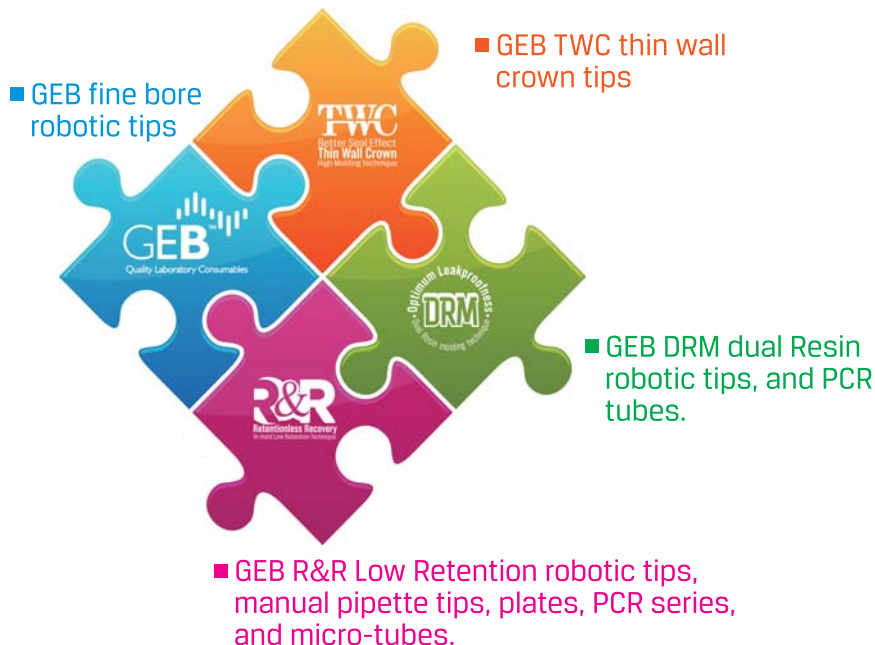

### GEB's SOLUTION for Accurate and Precise Reaction System Preparation

Accurate and precise reaction system preparation is not an easy task.

- Optimized tip fit is critical in terms of precise volume of liquid transferring.
- Reduced surface retention increases precision, reproducibility, and saves on reagents.

GEB's series innovation provides you a complete solution.

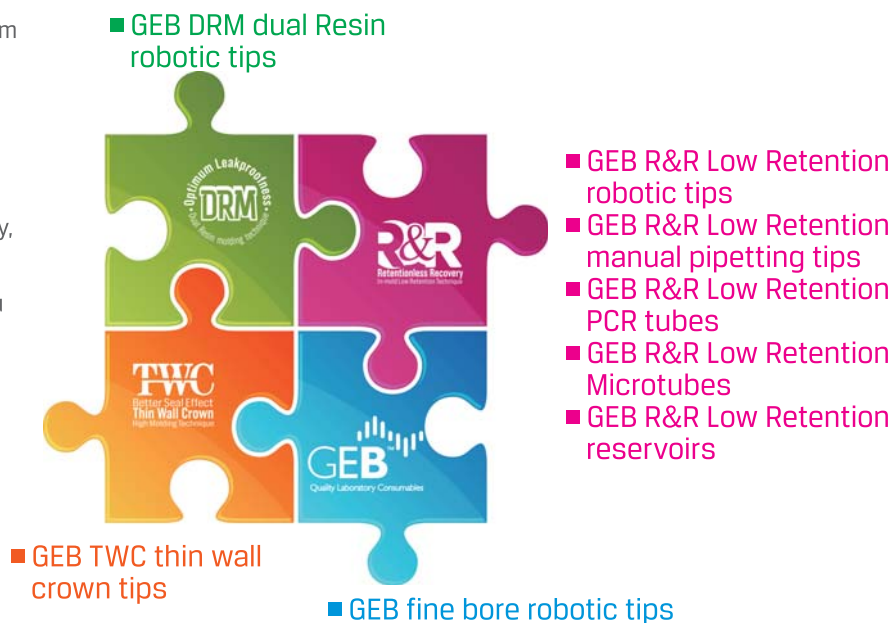



# GEB's Genuine Quality

## Certification

ISO9001:2008 • ISO13485:2003 • ISO14001:2004 • CE



## The Highest Standard of Quality Assurance



## The Highest Standard of Manufacturing



100,000 Grade Clean Workshop

International Standard Molding Machine

# Blue GEB, Your Better Choice

Excellent match of liquid workstations & GEB robotic tips

## Robotic Tips

### Accurate Liquid Handling

Genomics • Proteomics • Cellomics • Immunoassays • Metabolomics • General liquid handling



#### GEB DRM Dual Resin

Provide high flexibility for better fitting, lowering robotic head insertion force.

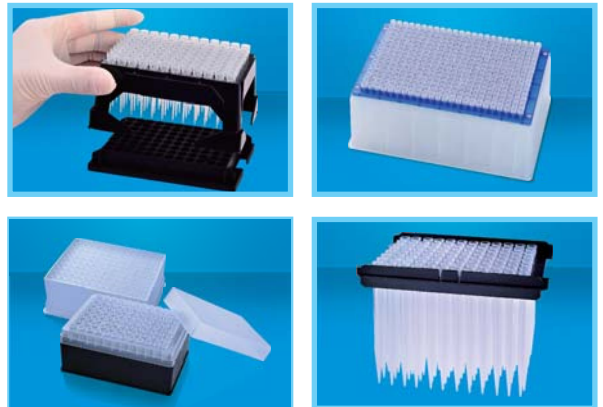

#### GEB TWC Thin Wall Crown

It provides you a better seal effect for robotic systems, and is more flexible and requires less insertion force.

Reliable, consistent and accurate sample preparation and delivery have become more critical than ever to ensure you to operate your robotic system with high accuracy, low waste, and more economy.

So, why don't you place your disposables from GEB, which will provide you so many options of robotic tips with high quality and innovation of thin crown wall technique, fine bore, GEB's exclusive Low Retention, and dual resin molding technique?

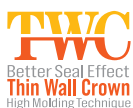

Provide a safer double safe cap lock system  
Provide a flexible half-lock position to prevent liquid evaporation during reagents pipetting



Minimize sample and reagent retention  
Guarantee reaction system accuracy and precision

Compatible with  
**Agilent / Agilent Bravo**  
**ROBOTIC TIPS**

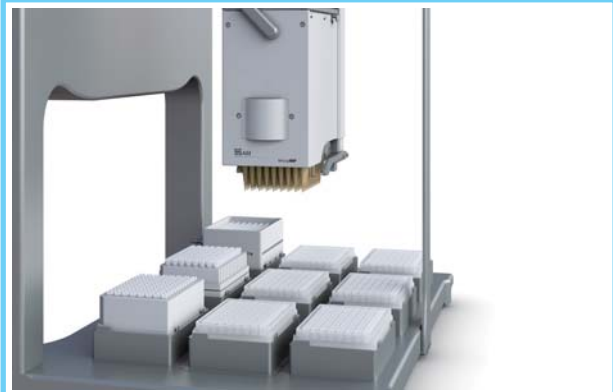

Format: 96-tip format  
Tip Volume range selection: 5~250µl  
Material: Natural Polypropylene  
Alternatives:  with/without aerosol-barrier filter  
 Pre-Sterilized/Non-Sterilized  
 Low Retention/Standard  
Certified: DNase-Free, RNase-Free, Endotoxin-Safe



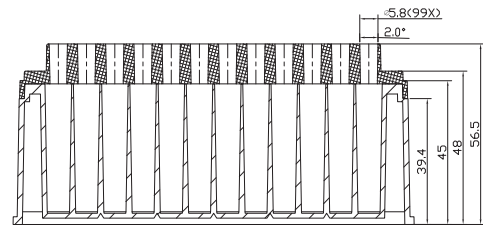
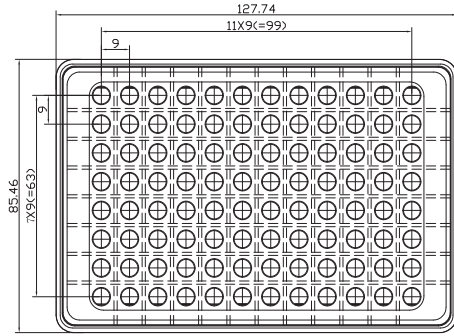





Material: Number 5 Polypropylene

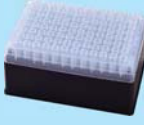

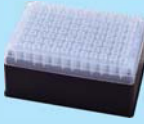
250µl | Compatible Head: 96LT & 8LT

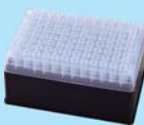

**Packaging Specification:**  
96 tips/rack, 10 racks/pack, 5 packs/case

Tip Type	Max Volume	Tip Color	Rack	Packaging	GEB Cat#
 Non-Filtered, Non-Sterilized	250µl	Natural		Racked	AT250A-9-N
 Low Retention Non-Filtered, Non-Sterilized	250µl	Natural		Racked	AT250A-9-N-LB
Non-Filtered, Pre-Sterilized	250µl	Natural		Racked	AT250A-9-N-S
 Low Retention Non-Filtered, Pre-Sterilized	250µl	Natural		Racked	AT250A-9-N-S-LB
 Filtered, Pre-Sterilized	170µl	Natural		Racked	AF250A-9-N-S
 Low Retention Filtered, Pre-Sterilized	170µl	Natural		Racked	AF250A-9-N-S-LB

# Blue GEB, Your Better Choice

Compatible with  
**Agilent / Agilent Bravo**  
ROBOTIC TIPS

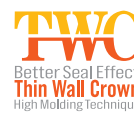

Format:384-tip format  
Tip Volume range selection:30µl  
Material:Natural Polypropylene  
Alternatives:● with/without aerosol-barrier filter  
● Pre-Sterilized/Non-Sterilized  
● Low Retention/Standard  
Certified:DNase-Free, RNase-Free, Endotoxin-Safe

Material: Number 5 Polypropylene

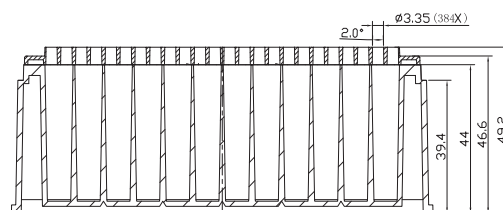
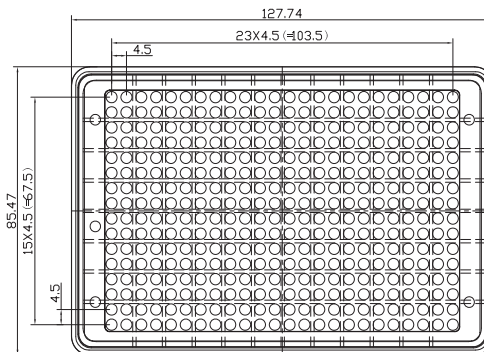

30µl | Compatible Head: 384LT



**Packaging Specification:**  
384 tips/rack, 10 racks/pack, 5 packs/case

	Tip Type	Max Volume	Tip Color	Rack	Packaging	GEB Cat#
	Non-Filtered, Non-Sterilized	30µl	Natural		Racked	AT030A-3-N
	Low Retention Non-Filtered, Non-Sterilized	30µl	Natural		Racked	AT030A-3-N-LB
	Non-Filtered, Pre-Sterilized	30µl	Natural		Racked	AT030A-3-N-S
	Low Retention Non-Filtered, Pre-Sterilized	30µl	Natural		Racked	AT030A-3-N-S-LB
	Filtered, Pre-Sterilized	30µl	Natural		Racked	AF030A-3-N-S
	Low Retention Filtered, Pre-Sterilized	30µl	Natural		Racked	AF030A-3-N-S-LB

Tips Compatible for  
**Beckman FX / NX, Multimek AP96 and Biomek 3000**  
**ROBOTIC TIPS**

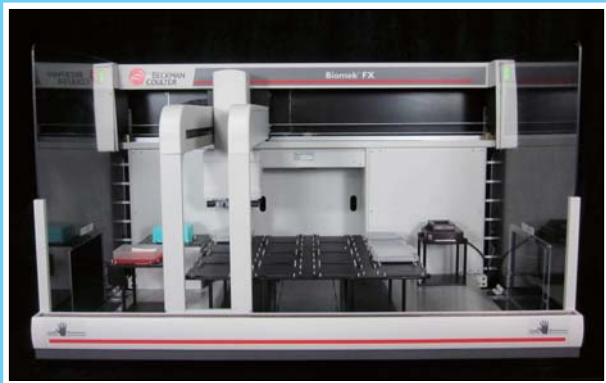

Format: 96-tip format  
 Tip Volume range selection: 20µl  
 Material: Natural Polypropylene  
 Alternatives:  with/without aerosol-barrier filter  
                    Pre-Sterilized/Non-Sterilized  
                    Low Retention/Standard  
 Certified: DNase-Free, RNase-Free, Endotoxin-Safe



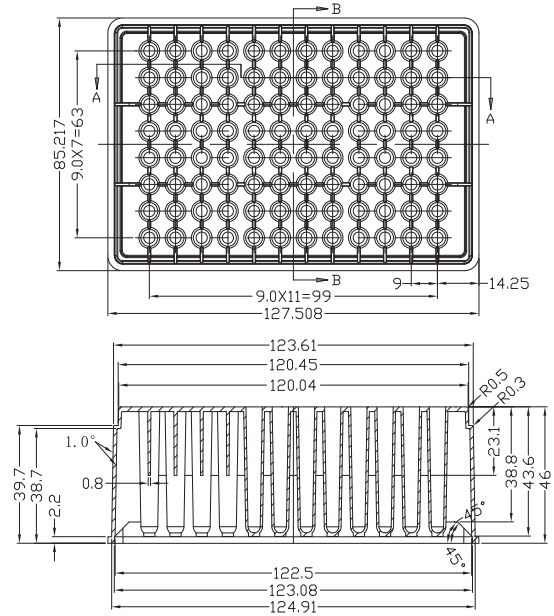





Material: Number 5 Polypropylene

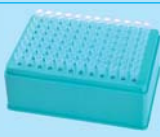

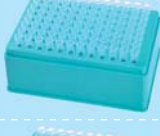
20µl | Compatible Head: AP-96 & 8

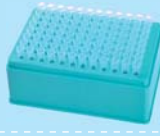

**Packaging Specification:**  
96 tips/rack, 10 racks/pack, 5 packs/case

Tip Type	Max Volume	Tip Color	Rack	Packaging	GEB Cat#
 Non-Filtered, Non-Sterilized	20µl	Natural		Racked	AT020B-9-N
 Low Retention Non-Filtered, Non-Sterilized	20µl	Natural		Racked	AT020B-9-N-LB
Non-Filtered, Pre-Sterilized	20µl	Natural		Racked	AT020B-9-N-S
 Low Retention Non-Filtered, Pre-Sterilized	20µl	Natural		Racked	AT020B-9-N-S-LB
 Filtered, Pre-Sterilized	20µl	Natural		Racked	AF020B-9-N-S
 Low Retention Filtered, Pre-Sterilized	20µl	Natural		Racked	AF020B-9-N-S-LB



# Blue GEB, Your Better Choice

Tips Compatible for  
**Beckman FX / NX, Multimek AP96 and Biomek 3000**  
**ROBOTIC TIPS**

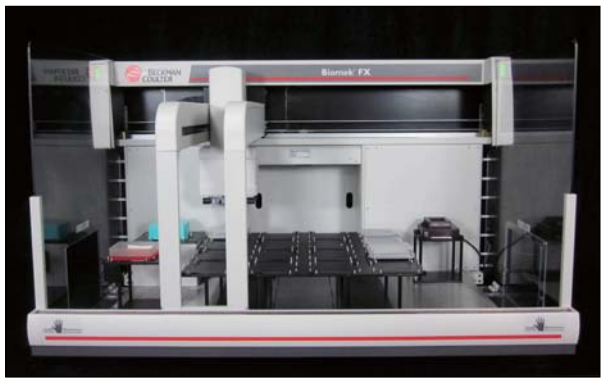

Format: 96-tip format  
 Tip Volume range selection: 20µl  
 Material: Conductive Polypropylene  
 Alternatives:  with/without aerosol-barrier filter  
                    Pre-Sterilized/Non-Sterilized  
                    Low Retention/Standard  
 Certified: DNase-Free, RNase-Free, Endotoxin-Safe



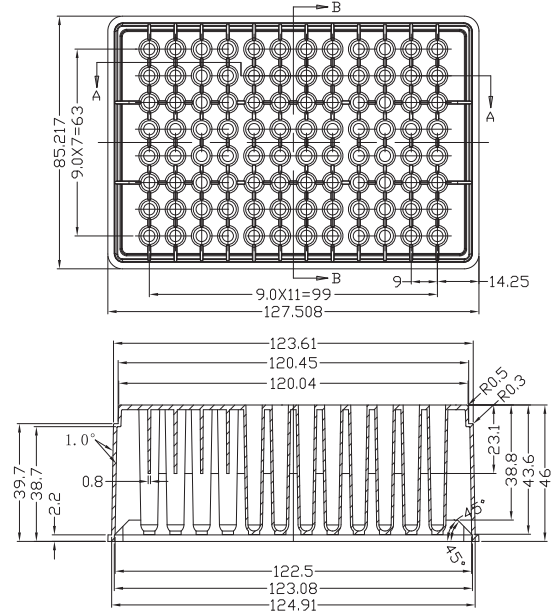





Material: Number 5 Polypropylene

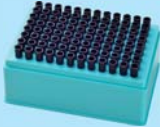

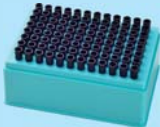
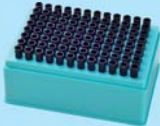
20µl | Compatible Head: AP-96 & 8

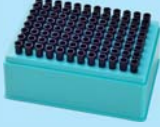

**Packaging Specification:**  
 96 tips/rack, 10 racks/pack, 5 packs/case

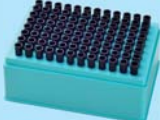
Tip Type	Max Volume	Tip Color	Rack	Packaging	GEB Cat#
 Non-Filtered, Non-Sterilized	20µl	Black		Racked	AT020B-9-X
 Low Retention Non-Filtered, Non-Sterilized	20µl	Black		Racked	AT020B-9-X-LB
Non-Filtered, Pre-Sterilized	20µl	Black		Racked	AT020B-9-XS
 Low Retention Non-Filtered, Pre-Sterilized	20µl	Black		Racked	AT020B-9-XS-LB
 Filtered, Pre-Sterilized	20µl	Black		Racked	AF020B-9-XS
 Low Retention Filtered, Pre-Sterilized	20µl	Black		Racked	AF020B-9-XS-LB

Tips Compatible for  
**Beckman FX / NX, Multimek AP96 and Biomek 3000**  
**ROBOTIC TIPS**

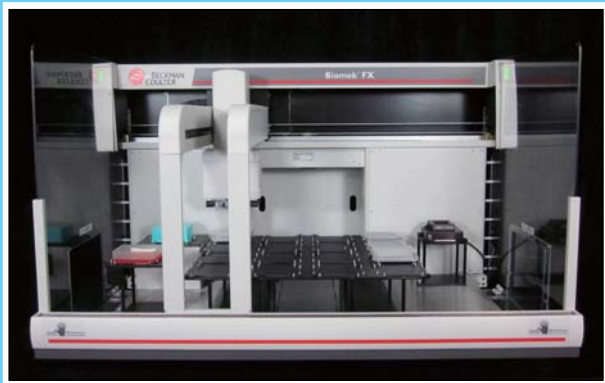

Format: 96-tip format  
 Tip Volume range selection: 250µl  
 Material: Natural Polypropylene  
 Alternatives:  with/without aerosol-barrier filter  
                    Pre-Sterilized/Non-Sterilized  
                    Low Retention/Standard  
 Certified: DNase-Free, RNase-Free, Endotoxin-Safe



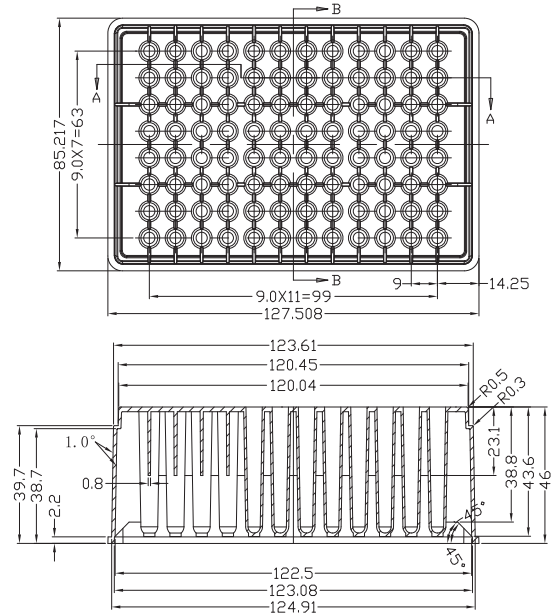







Material: Number 5 Polypropylene

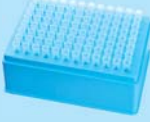

250µl | Compatible Head: AP-96



**Packaging Specification:**  
96 tips/rack, 10 racks/pack, 5 packs/case

Tip Type	Max Volume	Tip Color	Rack	Packaging	GEB Cat#
 Non-Filtered, Non-Sterilized	250µl	Natural		Racked	AT250B-9-N
 Low Retention Non-Filtered, Non-Sterilized	250µl	Natural		Racked	AT250B-9-N-LB
Non-Filtered, Pre-Sterilized	250µl	Natural		Racked	AT250B-9-N-S
 Low Retention Non-Filtered, Pre-Sterilized	250µl	Natural		Racked	AT250B-9-N-S-LB
 Filtered, Pre-Sterilized	180µl	Natural		Racked	AF250B-9-N-S
 Low Retention Filtered, Pre-Sterilized	180µl	Natural		Racked	AF250B-9-N-S-LB

# Blue GEB, Your Better Choice

Tips Compatible for  
**Beckman FX / NX, Multimek AP96 and Biomek 3000**  
**ROBOTIC TIPS**

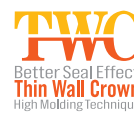

Format: 96-tip format  
 Tip Volume range selection: 250µl  
 Material: Conductive Polypropylene  
 Alternatives:  with/without aerosol-barrier filter  
                    Pre-Sterilized/Non-Sterilized  
                    Low Retention/Standard  
 Certified: DNase-Free, RNase-Free, Endotoxin-Safe



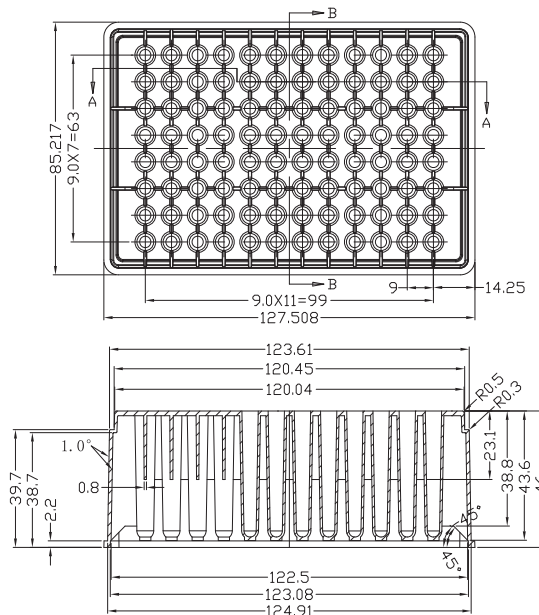



Material: Number 5 Polypropylene



250µl | Compatible Head: AP-96 & 8

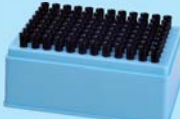

**Packaging Specification:**  
 96 tips/rack, 10 racks/pack, 5 packs/case

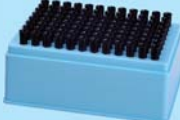
Tip Type	Max Volume	Tip Color	Rack	Packaging	GEB Cat#
 Non-Filtered, Non-Sterilized	250µl	Black		Racked	AT250B-9-X
 Low Retention Non-Filtered, Non-Sterilized	250µl	Black		Racked	AT250B-9-X-LB
Non-Filtered, Pre-Sterilized	250µl	Black		Racked	AT250B-9-XS
 Low Retention Non-Filtered, Pre-Sterilized	250µl	Black		Racked	AT250B-9-XS-LB
 Filtered, Pre-Sterilized	180µl	Black		Racked	AF250B-9-XS
 Low Retention Filtered, Pre-Sterilized	180µl	Black		Racked	AF250B-9-XS-LB

Tips Compatible for  
**Hamilton Star, Starlet and Nimbus**  
**ROBOTIC TIPS**



Material: Number 5 Polypropylene

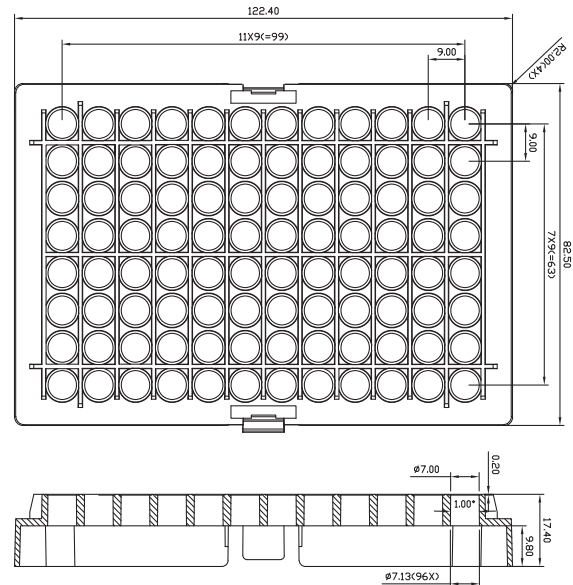

50µl | Compatible Head: 96



**Packaging Specification:**

(1) Dual Hanging Rack: 2×96 tips per rack; (2) the others: 96 tips per rack

Tip Type	Max Volume	Tip Color	Rack	Packaging	Packaging specifications	GEB Cat#
Non-Filtered, Non-Sterilized	50µl	Natural		Racked	24 racks per case	AT050H-H-N
 Low Retention Non-Filtered, Non-Sterilized	50µl	Natural		Racked	24 racks per case	AT050H-H-N-LB
Non-Filtered, Pre-Sterilized	50µl	Natural		Racked	24 racks per case	AT050H-H-N-S
 Low Retention Non-Filtered, Pre-Sterilized	50µl	Natural		Racked	24 racks per case	AT050H-H-N-S-LB
Filtered, Pre-Sterilized	50µl	Natural		Racked	24 racks per case	AF050H-H-N-S
 Low Retention Filtered, Pre-Sterilized	50µl	Natural		Racked	24 racks per case	AF050H-H-N-S-LB
Non-Filtered, Non-Sterilized	50µl	Natural		Dual Hanging Rack	5 racks per pack 10 packs per case	AT050H-H2-N
 Low Retention Non-Filtered, Non-Sterilized	50µl	Natural		Dual Hanging Rack	5 racks per pack 10 packs per case	AT050H-H2-N-LB
Filtered, Pre-Sterilized	50µl	Natural		Dual Hanging Rack	5 racks per pack 10 packs per case	AF050H-H2-N-S
 Low Retention Filtered, Pre-Sterilized	50µl	Natural		Dual Hanging Rack	5 racks per pack 10 packs per case	AF050H-H2-N-S-LB
Non-Filtered, Non-Sterilized	50µl	Natural		Nested Stack Rack	4 racks per pack 30 packs per case	AT050H-9N-N
 Low Retention Non-Filtered, Non-Sterilized	50µl	Natural		Nested Stack Rack	4 racks per pack 30 packs per case	AT050H-9N-N-LB
Filtered, Pre-Sterilized	50µl	Natural		Single Nested Rack	10 racks per pack 5 packs per case	AF050H-9-N-S
 Low Retention Filtered, Pre-Sterilized	50µl	Natural		Single Nested Rack	10 racks per pack 5 packs per case	AF050H-9-N-S-LB

# Blue GEB, Your Better Choice

Tips Compatible for  
**Hamilton Star, Starlet and Nimbus**  
**ROBOTIC TIPS**

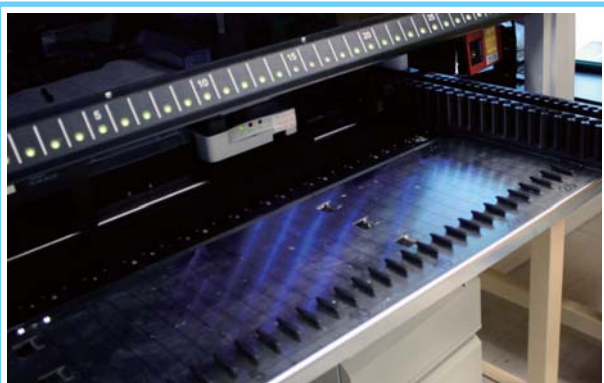
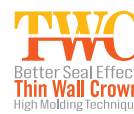

Format: 96-tip format  
 Tip Volume range selection: 300µl  
 Material: Natural Polypropylene  
 Alternatives:  with/without aerosol-barrier filter  
                    Pre-Sterilized/Non-Sterilized  
                    Low Retention/Standard  
 Certified: DNase-Free, RNase-Free, Endotoxin-Safe

Material: Number 5 Polypropylene

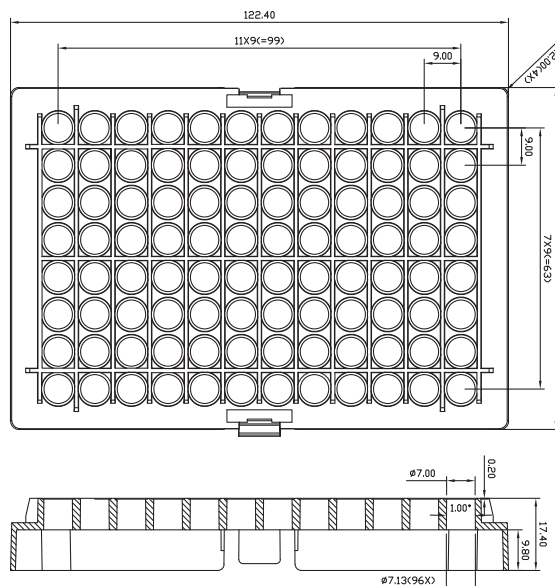

300µl Compatible Head: 96



### Packaging Specification:

(1) Dual Hanging Rack: 2x96 tips per rack; (2) the others: 96 tips per rack

Tip Type	Max Volume	Tip Color	Rack	Packaging	Packaging specifications	GEB Cat#
Non-Filtered, Non-Sterilized	300µl	Natural		Racked	24 racks per case	AT300H-H-N
Low Retention Non-Filtered, Non-Sterilized	300µl	Natural		Racked	24 racks per case	AT300H-H-N-LB
Non-Filtered, Pre-Sterilized	300µl	Natural		Racked	24 racks per case	AT300H-H-N-S
Low Retention Non-Filtered, Pre-Sterilized	300µl	Natural		Racked	24 racks per case	AT300H-H-N-S-LB
Filtered, Pre-Sterilized	300µl	Natural		Racked	24 racks per case	AF300H-H-N-S
Low Retention Filtered, Pre-Sterilized	300µl	Natural		Racked	24 racks per case	AF300H-H-N-S-LB
Non-Filtered, Non-Sterilized	300µl	Natural		Dual Hanging Rack	5 racks per pack 10 packs per case	AT300H-H2-N
Low Retention Non-Filtered, Non-Sterilized	300µl	Natural		Dual Hanging Rack	5 racks per pack 10 packs per case	AT300H-H2-N-LB
Filtered, Pre-Sterilized	300µl	Natural		Dual Hanging Rack	5 racks per pack 10 packs per case	AF300H-H2-N-S
Low Retention Filtered, Pre-Sterilized	300µl	Natural		Dual Hanging Rack	5 racks per pack 10 packs per case	AF300H-H2-N-S-LB
Non-Filtered, Non-Sterilized	300µl	Natural		Nestded Stack Rack	4 racks per pack 30 packs per case	AT300H-9N-N
Low Retention Non-Filtered, Non-Sterilized	300µl	Natural		Nestded Stack Rack	4 racks per pack 30 packs per case	AT300H-9N-N-LB
Filtered, Pre-Sterilized	300µl	Natural		Single Nestded Rack	10 racks per pack 5 packs per case	AF300H-9-N-S
Low Retention Filtered, Pre-Sterilized	300µl	Natural		Single Nestded Rack	10 racks per pack 5 packs per case	AF300H-9-N-S-LB

Tips Compatible for  
**Hamilton Star, Starlet and Nimbus**  
**ROBOTIC TIPS**



Material: Number 5 Polypropylene

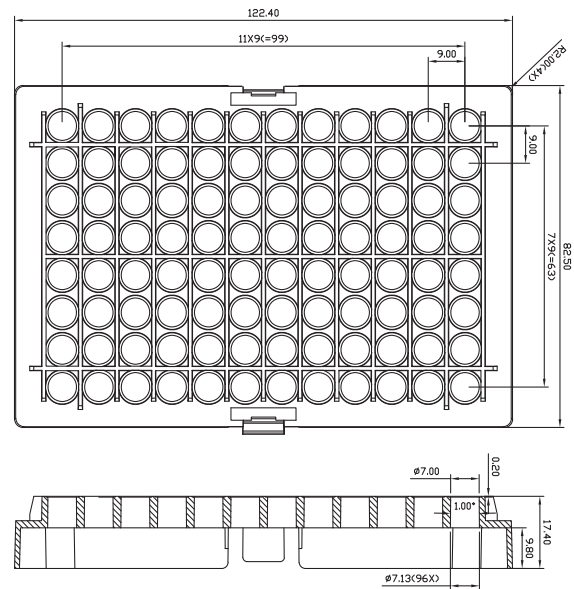







1000µl | Compatible Head: 96



**Packaging Specification:**

(1) Dual Hanging Rack: 2×96 tips per rack; (2) the others: 96 tips per rack

Tip Type	Max Volume	Tip Color	Rack	Packaging	Packaging specifications	GEB Cat#
Non-Filtered, Non-Sterilized	1000µl	Natural		Racked	16 racks per case	ATO1MH-H-N
 Low Retention Non-Filtered, Non-Sterilized	1000µl	Natural		Racked	16 racks per case	ATO1MH-H-N-LB
Non-Filtered, Pre-Sterilized	1000µl	Natural		Racked	16 racks per case	ATO1MH-H-N-S
 Low Retention Non-Filtered, Pre-Sterilized	1000µl	Natural		Racked	16 racks per case	ATO1MH-H-N-S-LB
Filtered, Pre-Sterilized	1000µl	Natural		Racked	16 racks per case	AF01MH-H-N-S
 Low Retention Filtered, Pre-Sterilized	1000µl	Natural		Racked	16 racks per case	AF01MH-H-N-S-LB
Non-Filtered, Non-Sterilized	1000µl	Natural		Dual Hanging Rack	5 racks per pack 10 packs per case	ATO1MH-H2-N
 Low Retention Non-Filtered, Non-Sterilized	1000µl	Natural		Dual Hanging Rack	5 racks per pack 10 packs per case	ATO1MH-H2-N-LB
Filtered, Pre-Sterilized	1000µl	Natural		Dual Hanging Rack	5 racks per pack 10 packs per case	AF01MH-H2-N-S
 Low Retention Filtered, Pre-Sterilized	1000µl	Natural		Dual Hanging Rack	5 racks per pack 10 packs per case	AF01MH-H2-N-S-LB

# Blue GEB, Your Better Choice

Tips Compatible for  
**Hamilton Star, Starlet and Nimbus**  
**ROBOTIC TIPS**



Format: 96-tip format  
 Tip Volume range selection: 50µl  
 Material: Conductive Polypropylene  
 Alternatives:  with/without aerosol-barrier filter  
                    Pre-Sterilized/Non-Sterilized  
                    Low Retention/Standard  
 Certified: DNase-Free, RNase-Free, Endotoxin-Safe

Material: Number 5 Polypropylene

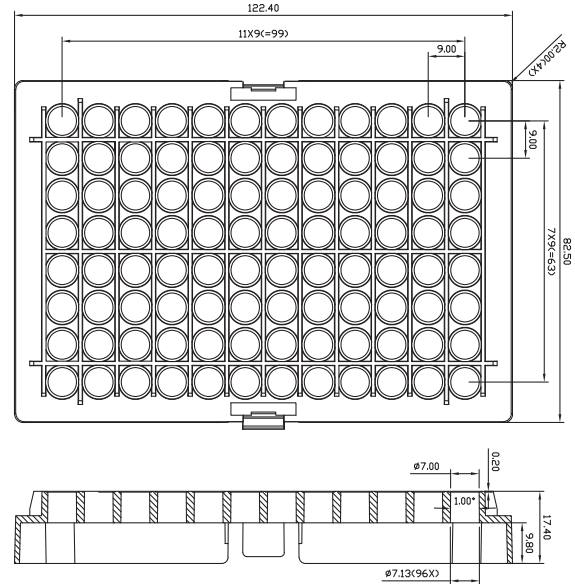

50µl | Compatible Head: 96



**Packaging Specification:**

(1) Dual Hanging Rack: 2x96 tips per rack; (2) the others: 96 tips per rack

Tip Type	Max Volume	Tip Color	Rack	Packaging	Packaging specifications	GEB Cat#
 Non-Filtered, Non-Sterilized	50µl	Black		Racked	24 racks per case	AT050H-H-X
 Low Retention Non-Filtered, Non-Sterilized	50µl	Black		Racked	24 racks per case	AT050H-H-X-LB
Non-Filtered, Pre-Sterilized	50µl	Black		Racked	24 racks per case	AT050H-H-XS
 Low Retention Non-Filtered, Pre-Sterilized	50µl	Black		Racked	24 racks per case	AT050H-H-XS-LB
Filtered, Pre-Sterilized	50µl	Black		Racked	24 racks per case	AF050H-H-XS
 Low Retention Filtered, Pre-Sterilized	50µl	Black		Racked	24 racks per case	AF050H-H-XS-LB
 Non-Filtered, Non-Sterilized	50µl	Black		Dual Hanging Rack	5 racks per pack 10 packs per case	AT050H-H2-X
Non-Filtered, Non-Sterilized 	50µl	Black		Dual Hanging Rack	5 racks per pack 10 packs per case	AT050H-H2-X-LB
Filtered, Pre-Sterilized	50µl	Black		Dual Hanging Rack	5 racks per pack 10 packs per case	AF050H-H2-XS
 Low Retention Filtered, Pre-Sterilized	50µl	Black		Dual Hanging Rack	5 racks per pack 10 packs per case	AF050H-H2-XS-LB
 Non-Filtered, Non-Sterilized	50µl	Black		Nested Stack Rack	4 racks per pack 30 packs per case	AT050H-9N-X
 Low Retention Non-Filtered, Non-Sterilized	50µl	Black		Nested Stack Rack	4 racks per pack 30 packs per case	AT050H-9N-X-LB
Filtered, Pre-Sterilized	50µl	Black		Single Nested Rack	10 racks per pack 5 packs per case	AF050H-9-XS
 Low Retention Filtered, Pre-Sterilized	50µl	Black		Single Nested Rack	10 racks per pack 5 packs per case	AF050H-9-XS-LB

Tips Compatible for  
**Hamilton Star, Starlet and Nimbus**  
**ROBOTIC TIPS**



Material: Number 5 Polypropylene

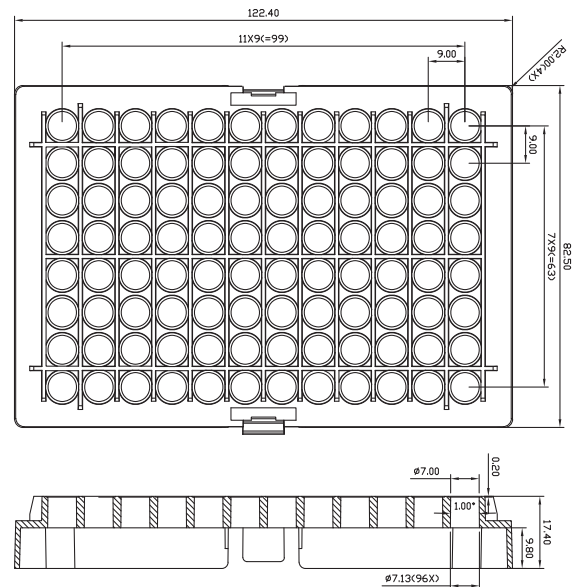

300µl | Compatible Head: 96



**Packaging Specification:**

(1)Dual Hanging Rack: 2×96 tips per rack; (2)the others: 96 tips per rack

	Tip Type	Max Volume	Tip Color	Rack	Packaging	Packaging specifications	GEB Cat#
	Non-Filtered, Non-Sterilized	300µl	Black		Racked	24 racks per case	AT300H-H-X
	 Low Retention Non-Filtered, Non-Sterilized	300µl	Black		Racked	24 racks per case	AT300H-H-X-LB
	Non-Filtered, Pre-Sterilized	300µl	Black		Racked	24 racks per case	AT300H-H-XS
	 Low Retention Non-Filtered, Pre-Sterilized	300µl	Black		Racked	24 racks per case	AT300H-H-XS-LB
	Filtered, Pre-Sterilized	300µl	Black		Racked	24 racks per case	AF300H-H-XS
	 Low Retention Filtered, Pre-Sterilized	300µl	Black		Racked	24 racks per case	AF300H-H-XS-LB
	Non-Filtered, Non-Sterilized	300µl	Black		Dual Hanging Rack	5 racks per pack 10 packs per case	AT300H-H2-X
	 Low Retention Non-Filtered, Non-Sterilized	300µl	Black		Dual Hanging Rack	5 racks per pack 10 packs per case	AT300H-H2-X-LB
	Filtered, Pre-Sterilized	300µl	Black		Dual Hanging Rack	5 racks per pack 10 packs per case	AF300H-H2-XS
	 Low Retention Filtered, Pre-Sterilized	300µl	Black		Dual Hanging Rack	5 racks per pack 10 packs per case	AF300H-H2-XS-LB
	Non-Filtered, Non-Sterilized	300µl	Black		Nested Stack Rack	4 racks per pack 30 packs per case	AT300H-9N-X
	 Low Retention Non-Filtered, Non-Sterilized	300µl	Black		Nested Stack Rack	4 racks per pack 30 packs per case	AT300H-9N-X-LB
	Filtered, Pre-Sterilized	300µl	Black		Single Nested Rack	10 racks per pack 5 packs per case	AF300H-9-XS
	 Low Retention Filtered, Pre-Sterilized	300µl	Black		Single Nested Rack	10 racks per pack 5 packs per case	AF300H-9-XS-LB



# Blue GEB, Your Better Choice

Tips Compatible for  
**Hamilton Star, Starlet and Nimbus**  
**ROBOTIC TIPS**

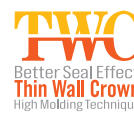

Format: 96-tip format  
 Tip Volume range selection: 1000µl  
 Material: conductive Polypropylene  
 Alternatives: ● with/without aerosol-barrier filter  
 ● Pre-Sterilized/Non-Sterilized  
 ● Low Retention/Standard  
 Certified: DNase-Free, RNase-Free, Endotoxin-Safe

Material: Number 5 Polypropylene

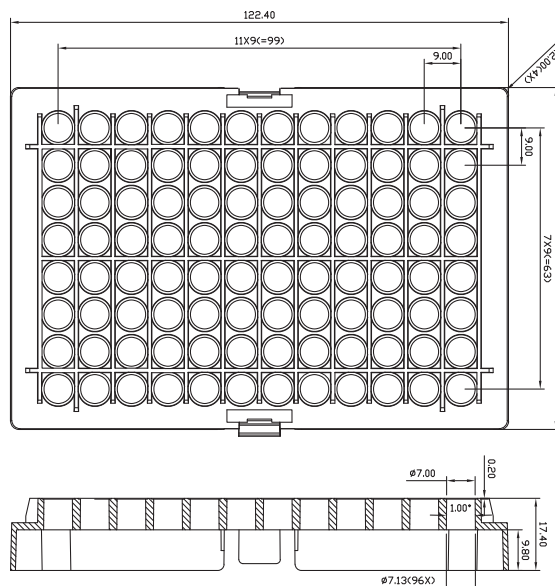

1000µl | Compatible Head: 96



### Packaging Specification:

(1) Dual Hanging Rack: 2×96 tips per rack; (2) the others: 96 tips per rack

Tip Type	Max Volume	Tip Color	Rack	Packaging	Packaging specifications	GEB Cat#
Non-Filtered, Non-Sterilized	1000µl	Black		Racked	16 racks per case	ATO1MH-H-X
Low Retention Non-Filtered, Non-Sterilized	1000µl	Black		Racked	16 racks per case	ATO1MH-H-X-LB
Non-Filtered, Pre-Sterilized	1000µl	Black		Racked	16 racks per case	ATO1MH-H-XS
Low Retention Non-Filtered, Pre-Sterilized	1000µl	Black		Racked	16 racks per case	ATO1MH-H-XS-LB
Filtered, Pre-Sterilized	1000µl	Black		Racked	16 racks per case	AF01MH-H-XS
Low Retention Filtered, Pre-Sterilized	1000µl	Black		Racked	16 racks per case	AF01MH-H-XS-LB
Non-Filtered, Non-Sterilized	1000µl	Black		Dual Hanging Rack	5 racks per pack 10 packs per case	ATO1MH-H2-X
Low Retention Non-Filtered, Non-Sterilized	1000µl	Black		Dual Hanging Rack	5 racks per pack 10 packs per case	ATO1MH-H2-X-LB
Filtered, Pre-Sterilized	1000µl	Black		Dual Hanging Rack	5 racks per pack 10 packs per case	AF01MH-H2-XS
Low Retention Filtered, Pre-Sterilized	1000µl	Black		Dual Hanging Rack	5 racks per pack 10 packs per case	AF01MH-H2-XS-LB

Tips Compatible for  
**Tecan Genesis Freedom® | Freedom Evo® | Miniprep with LiHa**  
**ROBOTIC TIPS**

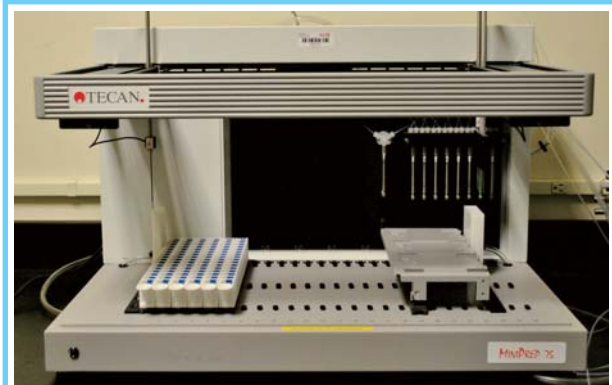

Material: Number 5 Polypropylene

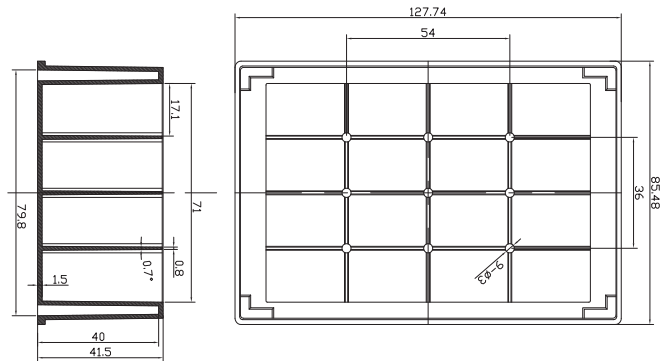

Format: 96-tip format  
Tip Volume range selection: 20µl  
Material: Natural Polypropylene  
Alternatives:  with/without aerosol-barrier filter  
 Pre-Sterilized/Non-Sterilized  
 Low Retention/Standard  
Certified: DNase-Free, RNase-Free, Endotoxin-Safe

20µl | Compatible Head: 96



**Packaging Specification:**

(1) Dual Hanging Rack: 2×96 tips per rack; (2) the others: 96 tips per rack

	Tip Type	Max Volume	Tip Color	Rack	Packaging	Packaging specifications	GEB Cat#
	Non-Filtered, Non-Sterilized	20µl	Natural		Racked	24 racks per case	AT020T-H-N
	Low Retention Non-Filtered, Non-Sterilized	20µl	Natural		Racked	24 racks per case	AT020T-H-N-LB
	Non-Filtered, Pre-Sterilized	20µl	Natural		Racked	24 racks per case	AT020T-H-N-S
	Low Retention Non-Filtered, Pre-Sterilized	20µl	Natural		Racked	24 racks per case	AT020T-H-N-S-LB
	Filtered, Pre-Sterilized	10µl	Natural		Racked	24 racks per case	AF020T-H-N-S
	Low Retention Filtered, Pre-Sterilized	10µl	Natural		Racked	24 racks per case	AF020T-H-N-S-LB
	Non-Filtered, Non-Sterilized	20µl	Natural		Dual Hanging Rack	5 racks per pack 10 packs per case	AT020T-H2-N
	Low Retention Non-Filtered, Non-Sterilized	20µl	Natural		Dual Hanging Rack	5 racks per pack 10 packs per case	AT020T-H2-N-LB
	Filtered, Pre-Sterilized	10µl	Natural		Dual Hanging Rack	5 racks per pack 10 packs per case	AF020T-H2-N-S
	Low Retention Filtered, Pre-Sterilized	10µl	Natural		Dual Hanging Rack	5 racks per pack 10 packs per case	AF020T-H2-N-S-LB

# Blue GEB, Your Better Choice

Tips Compatible for

**Tecan Genesis Freedom® | Freedom Evo® | Miniprep with LiHa**  
**ROBOTIC TIPS**

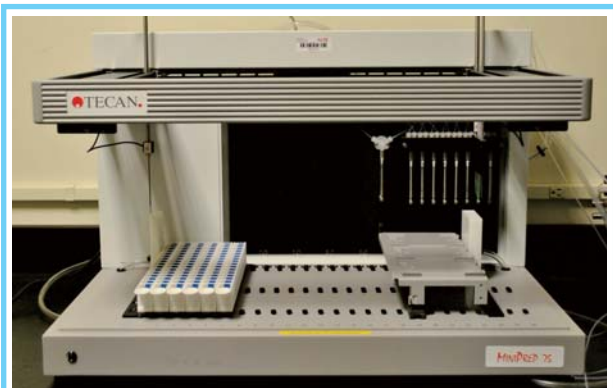
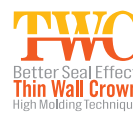

Material: Number 5 Polypropylene

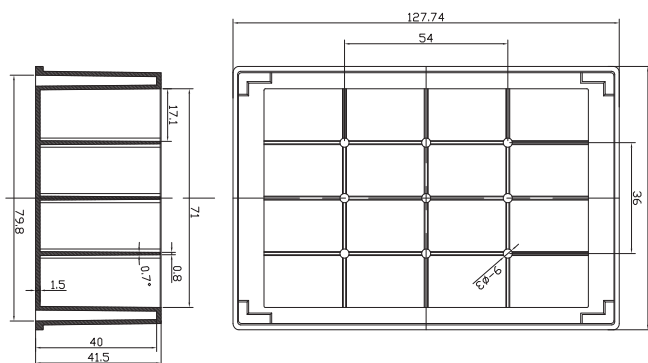

Format: 96-tip format  
 Tip Volume range selection: 200µl  
 Material: Natural Polypropylene  
 Alternatives:  with/without aerosol-barrier filter  
                    Pre-Sterilized/Non-Sterilized  
                    Low Retention/Standard  
 Certified: DNase-Free, RNase-Free, Endotoxin-Safe

200µl | Compatible Head: 96



**Packaging Specification:**

(1) Dual Hanging Rack: 2×96 tips per rack; (2) the others: 96 tips per rack

	Tip Type	Max Volume	Tip Color	Rack	Packaging	Packaging specifications	GEB Cat#
	Non-Filtered, Non-Sterilized	200µl	Natural		Racked	24 racks per case	AT200T-H-N
	Low Retention Non-Filtered, Non-Sterilized	200µl	Natural		Racked	24 racks per case	AT200T-H-N-LB
	Non-Filtered, Pre-Sterilized	200µl	Natural		Racked	24 racks per case	AT200T-H-N-S
	Low Retention Non-Filtered, Pre-Sterilized	200µl	Natural		Racked	24 racks per case	AT200T-H-N-S-LB
	Filtered, Pre-Sterilized	200µl	Natural		Racked	24 racks per case	AF200T-H-N-S
	Low Retention Filtered, Pre-Sterilized	200µl	Natural		Racked	24 racks per case	AF200T-H-N-S-LB
	Non-Filtered, Non-Sterilized	200µl	Natural		Dual Hanging Rack	5 racks per pack 10 packs per case	AT200T-H2-N
	Low Retention Non-Filtered, Non-Sterilized	200µl	Natural		Dual Hanging Rack	5 racks per pack 10 packs per case	AT200T-H2-N-LB
	Filtered, Pre-Sterilized	200µl	Natural		Dual Hanging Rack	5 racks per pack 10 packs per case	AF200T-H2-N-S
	Low Retention Filtered, Pre-Sterilized	200µl	Natural		Dual Hanging Rack	5 racks per pack 10 packs per case	AF200T-H2-N-S-LB

Tips Compatible for  
**Tecan Genesis Freedom® | Freedom Evo® | Miniprep with LiHa**  
**ROBOTIC TIPS**

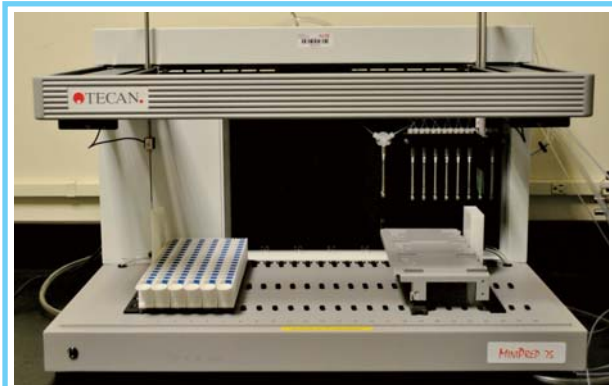

Material: Number 5 Polypropylene

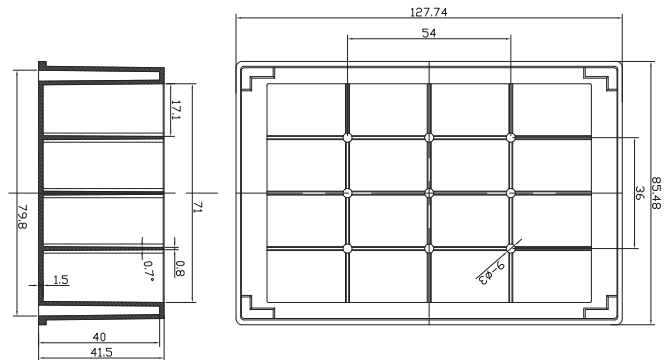

Format: 96-tip format  
Tip Volume range selection: 1000µl  
Material: Natural Polypropylene  
Alternatives:  with/without aerosol-barrier filter  
                   Pre-Sterilized/Non-Sterilized  
                   Low Retention/Standard  
Certified: DNase-Free, RNase-Free, Endotoxin-Safe

1000µl | Compatible Head: 96



**Packaging Specification:**

(1) Dual Hanging Rack: 2×96 tips per rack; (2) the others: 96 tips per rack

Tip Type	Max Volume	Tip Color	Rack	Packaging	Packaging specifications	GEB Cat#
Non-Filtered, Non-Sterilized	1000µl	Natural		Racked	16 racks per case	ATO1MT-H-N
 Low Retention Non-Filtered, Non-Sterilized	1000µl	Natural		Racked	16 racks per case	ATO1MT-H-N-LB
Non-Filtered, Pre-Sterilized	1000µl	Natural		Racked	16 racks per case	ATO1MT-H-N-S
 Low Retention Non-Filtered, Pre-Sterilized	1000µl	Natural		Racked	16 racks per case	ATO1MT-H-N-S-LB
Filtered, Pre-Sterilized	900µl	Natural		Racked	16 racks per case	AF01MT-H-N-S
 Low Retention Filtered, Pre-Sterilized	1000µl	Natural		Racked	16 racks per case	AF01MT-H-N-S-LB
Non-Filtered, Non-Sterilized	100Ql	Natural		Dual Hanging Rack	5 racks per pack 10 packs per case	ATO1MT-H2-N
 Low Retention Non-Filtered, Non-Sterilized	100Ql	Natural		Dual Hanging Rack	5 racks per pack 10 packs per case	ATO1MT-H2-N-LB
Filtered, Pre-Sterilized	900µl	Natural		Dual Hanging Rack	5 racks per pack 10 packs per case	AF01MT-H2-N-S
 Low Retention Filtered, Pre-Sterilized	900µl	Natural		Dual Hanging Rack	5 racks per pack 10 packs per case	AF01MT-H2-N-S-LB

# Blue GEB, Your Better Choice

Tips Compatible for

**Tecan Genesis Freedom® | Freedom Evo® | Miniprep with LiHa**  
**ROBOTIC TIPS**

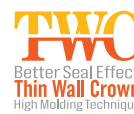

Format: 96-tip format  
 Tip Volume range selection: 20µl  
 Material: Conductive Polypropylene  
 Alternatives:  with/without aerosol-barrier filter  
                    Pre-Sterilized/Non-Sterilized  
                    Low Retention/Standard  
 Certified: DNase-Free, RNase-Free, Endotoxin-Safe

Material: Number 5 Polypropylene

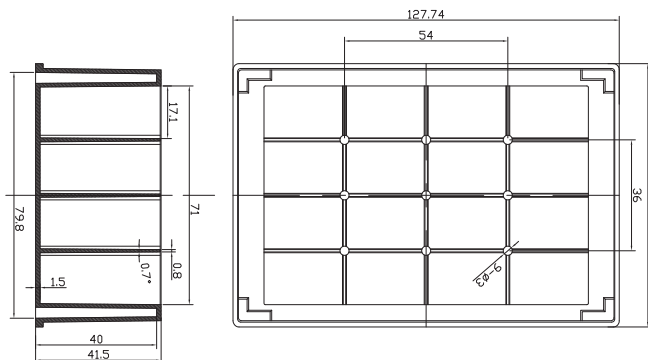

20µl | Compatible Head: 96



### Packaging Specification:

(1) Dual Hanging Rack: 2×96 tips per rack; (2) the others: 96 tips per rack

	Tip Type	Max Volume	Tip Color	Rack	Packaging	Packaging specifications	GEB Cat#
	Non-Filtered, Non-Sterilized 20µl		Black		Racked	24 racks per case	AT020T-H-X
	Low Retention Non-Filtered, Non-Sterilized	20µl	Black		Racked	24 racks per case	AT020T-H-X-LB
	Non-Filtered, Pre-Sterilized	20µl	Black		Racked	24 racks per case	AT020T-H-XS
	Low Retention Non-Filtered, Pre-Sterilized	20µl	Black		Racked	24 racks per case	AT020T-H-XS-LB
	Filtered, Pre-Sterilized	10µl	Black		Racked	24 racks per case	AF020T-H-XS
Low Retention Filtered, Pre-Sterilized	10µl	Black		Racked	24 racks per case	AF020T-H-XS-LB	
	Non-Filtered, Non-Sterilized 20µl		Black		Dual Hanging Rack	5 racks per pack 10 packs per case	AT020T-H2-X
	Low Retention Non-Filtered, Non-Sterilized	20µl	Black		Dual Hanging Rack	5 racks per pack 10 packs per case	AT020T-H2-X-LB
	Filtered, Pre-Sterilized	10µl	Black		Dual Hanging Rack	5 racks per pack 10 packs per case	AF020T-H2-XS
	Low Retention Filtered, Pre-Sterilized	10µl	Black		Dual Hanging Rack	5 racks per pack 10 packs per case	AF020T-H2-XS-LB

Tips Compatible for  
**Tecan Genesis Freedom® | Freedom Evo® | Miniprep with LiHa**  
**ROBOTIC TIPS**

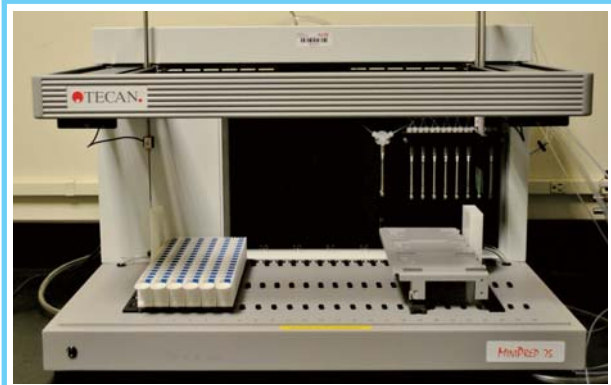

Format: 96-tip format  
Tip Volume range selection: 200µl  
Material: Conductive Polypropylene  
Alternatives:  with/without aerosol-barrier filter  
 Pre-Sterilized/Non-Sterilized  
 Low Retention/Standard  
Certified: DNase-Free, RNase-Free, Endotoxin-Safe

Material: Number 5 Polypropylene

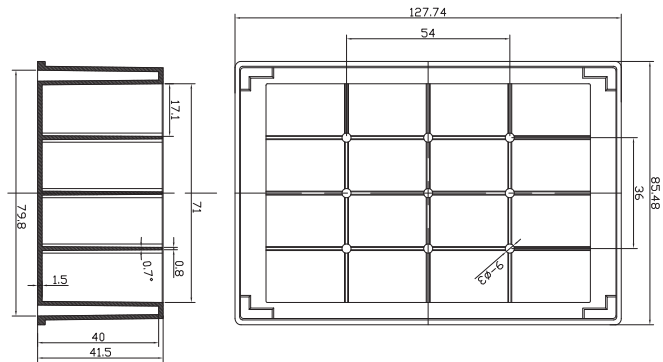





200µl | Compatible Head: 96

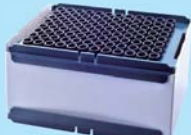

**Packaging Specification:**

(1) Dual Hanging Rack: 2×96 tips per rack; (2) the others: 96 tips per rack

Tip Type	Max Volume	Tip Color	Rack	Packaging	Packaging specifications	GEB Cat#
 Non-Filtered, Non-Sterilized	200µl	Black		Racked	24 racks per case	AT200T-H-X
 Low Retention Non-Filtered, Non-Sterilized	200µl	Black		Racked	24 racks per case	AT200T-H-X-LB
Non-Filtered, Pre-Sterilized	200µl	Black		Racked	24 racks per case	AT200T-H-XS
 Low Retention Non-Filtered, Pre-Sterilized	200µl	Black		Racked	24 racks per case	AT200T-H-XS-LB
Filtered, Pre-Sterilized	200µl	Black		Racked	24 racks per case	AF200T-H-XS
 Low Retention Filtered, Pre-Sterilized	200µl	Black		Racked	24 racks per case	AF200T-H-XS-LB
 Non-Filtered, Non-Sterilized	200µl	Black		Dual Hanging Rack	5 racks per pack 10 packs per case	AT200T-H2-X
 Low Retention Non-Filtered, Non-Sterilized	200µl	Black		Dual Hanging Rack	5 racks per pack 10 packs per case	AT200T-H2-X-LB
Filtered, Pre-Sterilized	200µl	Black		Dual Hanging Rack	5 racks per pack 10 packs per case	AF200T-H2-XS
 Low Retention Filtered, Pre-Sterilized	200µl	Black		Dual Hanging Rack	5 racks per pack 10 packs per case	AF200T-H2-XS-LB

# Blue GEB, Your Better Choice

Tips Compatible for

**Tecan Genesis Freedom® | Freedom Evo® | Miniprep with LiHa**  
**ROBOTIC TIPS**

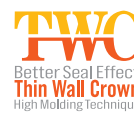

Format: 96-tip format  
 Tip Volume range selection: 1000µl  
 Material: Conductive Polypropylene  
 Alternatives:  with/without aerosol-barrier filter  
                    Pre-Sterilized/Non-Sterilized  
                    Low Retention/Standard  
 Certified: DNase-Free, RNase-Free, Endotoxin-Safe

Material: Number 5 Polypropylene

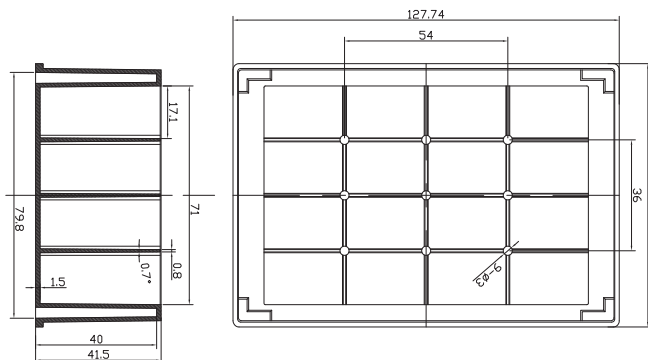

1000µl | Compatible Head: 96



### Packaging Specification:

(1) Dual Hanging Rack: 2×96 tips per rack; (2) the others: 96 tips per rack

Tip Type	Max Volume	Tip Color	Rack	Packaging	Packaging specifications	GEB Cat#
Non-Filtered, Non-Sterilized	1000µl	Black		Racked	16 racks per case	AT01MT-H-X
 Low Retention Non-Filtered, Non-Sterilized	1000µl	Black		Racked	16 racks per case	AT01MT-H-X-LB
Non-Filtered, Pre-Sterilized	1000µl	Black		Racked	16 racks per case	AT01MT-H-XS
 Low Retention Non-Filtered, Pre-Sterilized	1000µl	Black		Racked	16 racks per case	AT01MT-H-XS-LB
Filtered, Pre-Sterilized	900µl	Black		Racked	16 racks per case	AF01MT-H-XS
 Low Retention Filtered, Pre-Sterilized	900µl	Black		Racked	16 racks per case	AF01MT-H-XS-LB
Non-Filtered, Non-Sterilized	1000µl	Black		Dual Hanging Rack	5 racks per pack 10 packs per case	AT01MT-H2-X
 Low Retention Non-Filtered, Non-Sterilized	1000µl	Black		Dual Hanging Rack	5 racks per pack 10 packs per case	AT01MT-H2-X-LB
Filtered, Pre-Sterilized	900µl	Black		Dual Hanging Rack	5 racks per pack 10 packs per case	AF01MT-H2-XS
 Low Retention Filtered, Pre-Sterilized	900µl	Black		Dual Hanging Rack	5 racks per pack 10 packs per case	AF01MT-H2-XS-LB

Tips Compatible for  
**Tecan Mca**  
**ROBOTIC TIPS**



Material: Number 5 Polypropylene

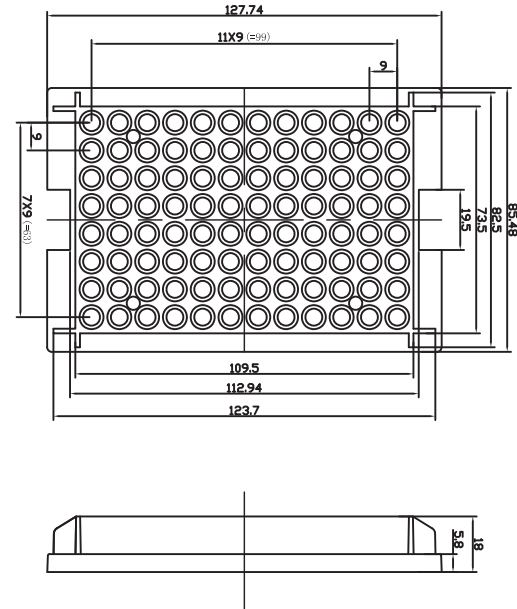
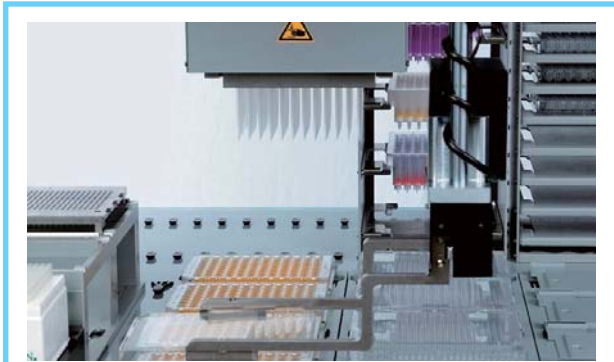











Format: 96-tip format  
Tip Volume range selection: 50µl  
Material: Natural Polypropylene  
Alternatives:  with/without aerosol-barrier filter  
                   Pre-Sterilized/Non-Sterilized  
                   Low Retention/Standard  
Certified: DNase-Free, RNase-Free, Endotoxin-Safe

50µl | Compatible Head: AZT-96

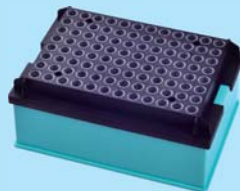

**Packaging Specification:**

(1) Refillable Rack: 96 tips per rack, 8 racks per stack, 10 stacks per case (2) Racked: 96 tips per rack

Tip Type	Max Volume	Tip Color	Rack	Packaging	GEB Cat#
 Non-Filtered, Non-Sterilized	50µl	Natural		Racked	AT050M-9-N
 Low Retention Non-Filtered, Non-Sterilized	50µl	Natural		Racked	AT050M-9-N-LB
 Non-Filtered, Pre-Sterilized	50µl	Natural		Racked	AT050M-9-N-S
 Low Retention Non-Filtered, Pre-Sterilized	50µl	Natural		Racked	AT050M-9-N-S-LB
 Filtered, Pre-Sterilized	50µl	Natural		Racked	AF050M-9-N-S
 Low Retention Filtered, Pre-Sterilized	50µl	Natural		Racked	AF050M-9-N-S-LB
 Non-Filtered, Non-Sterilized	50µl	Natural		Refillable Rack	AT050M-9N-N
 Low Retention Non-Filtered, Non-Sterilized	50µl	Natural		Refillable Rack	AT050M-9N-N-LB



# Blue GEB, Your Better Choice

Tips Compatible for  
**Tecan Mca**  
**ROBOTIC TIPS**



Format: 96-tip format  
 Tip Volume range selection: 200µl  
 Material: Natural Polypropylene  
 Alternatives:  with/without aerosol-barrier filter  
                    Pre-Sterilized/Non-Sterilized  
                    Low Retention/Standard  
 Certified: DNase-Free, RNase-Free, Endotoxin-Safe

Material: Number 5 Polypropylene

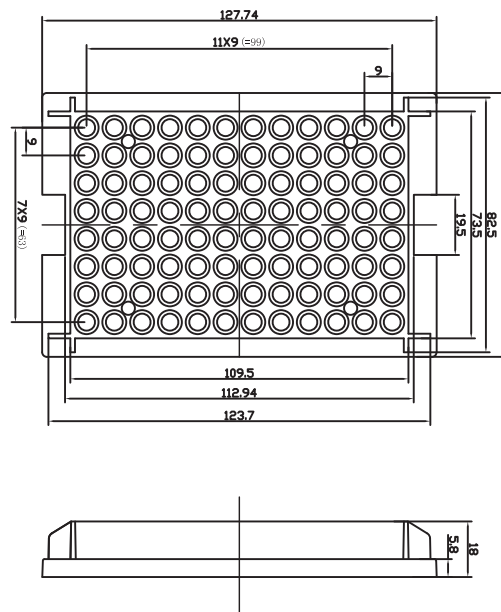

200µl | Compatible Head: AP-96



### Packaging Specification:

(1) Refillable Rack: 96 tips per rack, 8 racks per stack, 10 stacks per case (2) Racked: 96 tips per rack

Tip Type	Max Volume	Tip Color	Rack	Packaging	GEB Cat#
 Non-Filtered, Non-Sterilized	200µl	Natural		Racked	AT200M-9-N
 Low Retention Non-Filtered, Non-Sterilized	200µl	Natural		Racked	AT200M-9-N-S-LB
Non-Filtered, Pre-Sterilized	200µl	Natural		Racked	AT200M-9-N-S
 Low Retention Non-Filtered, Pre-Sterilized	200µl	Natural		Racked	AT200M-9-N-LB
 Filtered, Pre-Sterilized	180µl	Natural		Racked	AF200M-9-N-S
 Low Retention Filtered, Pre-Sterilized	180µl	Natural		Racked	AF200M-9-N-S-LB
 Non-Filtered, Non-Sterilized	200µl	Natural		Refillable Rack	AT200M-9N-N
 Low Retention Non-Filtered, Non-Sterilized	200µl	Natural		Refillable Rack	AT200M-9N-N-LB

Tips Compatible for  
**PerkinElmer Janus® | MultiProbe**  
**ROBOTIC TIPS**



Format: 96-tip format  
 Tip Volume range selection: 20µl  
 Material: Natural Polypropylene  
 Alternatives:  with/without aerosol-barrier filter  
                    Pre-Sterilized/Non-Sterilized  
                    Low Retention/Standard  
 Certified: DNase-Free, RNase-Free, Endotoxin-Safe



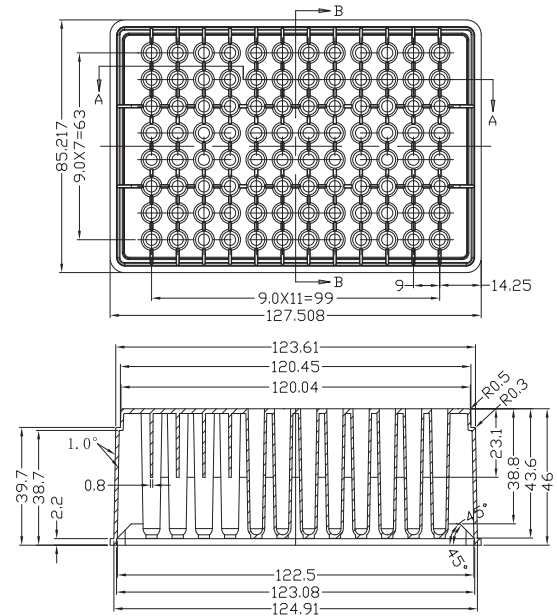



Material: Number 5 Polypropylene



20µl | Compatible Head: AP-96



**Packaging Specification:**  
96 tips/rack, 10 racks/pack, 5 packs/case

Tip Type	Max Volume	Tip Color	Rack	Packaging	GEB Cat#
 Non-Filtered, Non-Sterilized	20µl	Natural		Racked	AT020P-9-N
 Low Retention Non-Filtered, Non-Sterilized	20µl	Natural		Racked	AT020P-9-N-LB
Non-Filtered, Pre-Sterilized	20µl	Natural		Racked	AT020P-9-N-S
 Low Retention Non-Filtered, Pre-Sterilized	20µl	Natural		Racked	AT020P-9-N-S-LB
 Filtered, Pre-Sterilized	10µl	Natural		Racked	AF020P-9-N-S
 Low Retention Filtered, Pre-Sterilized	10µl	Natural		Racked	AF020P-9-N-S-LB

# Blue GEB, Your Better Choice

Tips Compatible for  
**PerkinElmer Janus® | MultiProbe**  
**ROBOTIC TIPS**





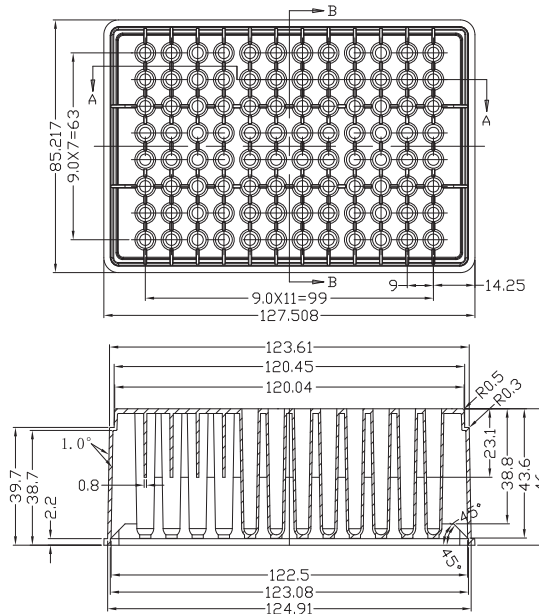





Material: Number 5 Polypropylene

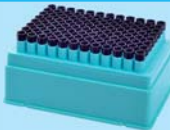

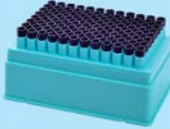
20µl | Compatible Head: AP-96

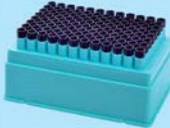

**Packaging Specification:**  
 96 tips/rack, 10 racks/pack, 5 packs/case

Tip Type	Max Volume	Tip Color	Rack	Packaging	GEB Cat#
 Non-Filtered, Non-Sterilized	20µl	Black		Racked	AT020P-9-X
 Low Retention Non-Filtered, Non-Sterilized	20µl	Black		Racked	AT020P-9-X-LB
Non-Filtered, Pre-Sterilized	20µl	Black		Racked	AT020P-9-XS
 Low Retention Non-Filtered, Pre-Sterilized	20µl	Black		Racked	AT020P-9-XS-LB
 Filtered, Pre-Sterilized	10µl	Black		Racked	AF020P-9-XS
 Low Retention Filtered, Pre-Sterilized	10µl	Black		Racked	AF020P-9-XS-LB

Tips Compatible for  
**PerkinElmer Janus® | MultiProbe**  
**ROBOTIC TIPS**

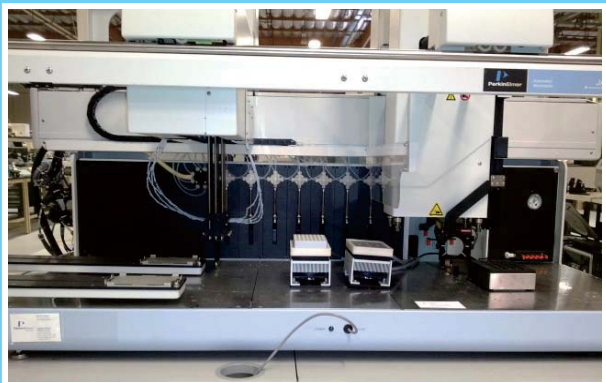

Format: 96-tip format  
 Tip Volume range selection: 200µl  
 Material: Natural Polypropylene  
 Alternatives:  with/without aerosol-barrier filter  
                    Pre-Sterilized/Non-Sterilized  
                    Low Retention/Standard  
 Certified: DNase-Free, RNase-Free, Endotoxin-Safe



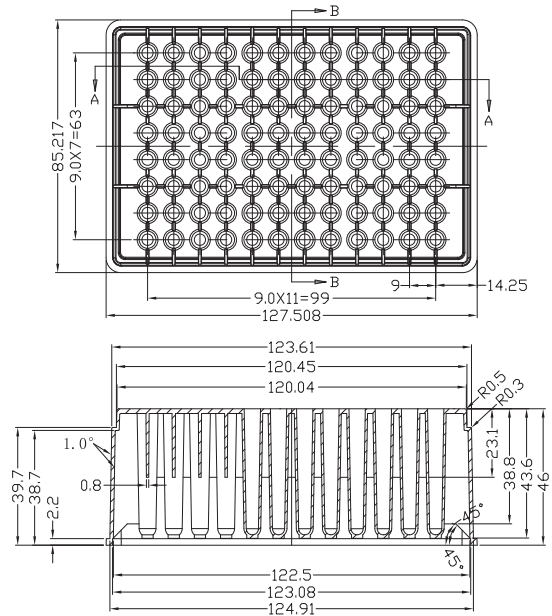





Material: Number 5 Polypropylene

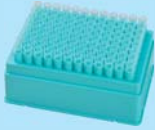

200µl | Compatible Head: AP-96

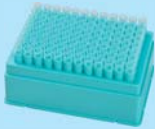

Packaging Specification:  
96 tips/rack, 10 racks/pack, 5 packs/case

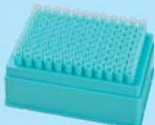
Tip Type	Max Volume	Tip Color	Rack	Packaging	GEB Cat#
 Non-Filtered, Non-Sterilized	200µl	Natural		Racked	AT200P-9-N
 Low Retention Non-Filtered, Non-Sterilized	200µl	Natural		Racked	AT200P-9-N-LB
Non-Filtered, Pre-Sterilized	200µl	Natural		Racked	AT200P-9-N-S
 Low Retention Non-Filtered, Pre-Sterilized	200µl	Natural		Racked	AT200P-9-N-S-LB
 Filtered, Pre-Sterilized	175µl	Natural		Racked	AF200P-9-N-S
 Low Retention Filtered, Pre-Sterilized	175µl	Natural		Racked	AF200P-9-N-S-LB

# Blue GEB, Your Better Choice

Tips Compatible for  
**PerkinElmer Janus® | MultiProbe**  
**ROBOTIC TIPS**

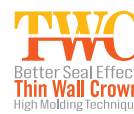

**Fc**  
 Tip volume range selection: 200µl  
 Material: Conductive Polypropylene  
 Alternatives: ○ with/without aerosol-barrier filter  
                   ○ Pre-Sterilized/Non-Sterilized  
                   ○ Low Retention/Standard  
 Certified: DNase-Free, RNase-Free, Endotoxin-Safe



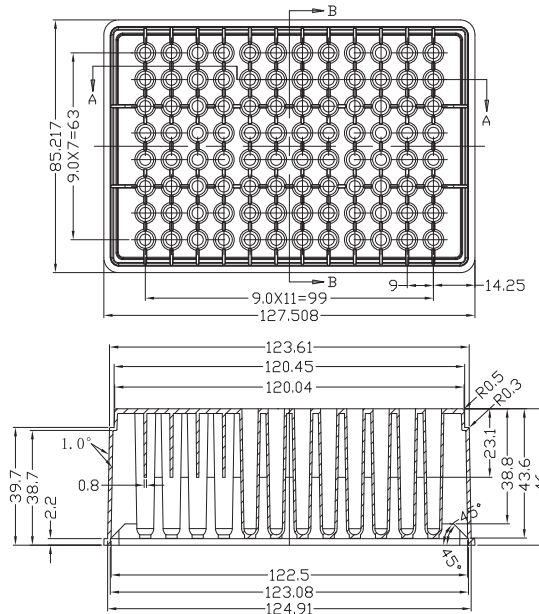





Material: Number 5 Polypropylene

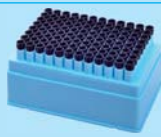

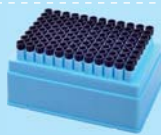
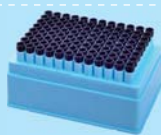
Compatible Head: AP-96

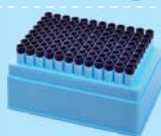

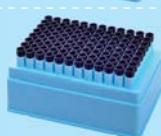
**Packaging Specification:**  
 96 tips/rack, 10 racks/pack, 5 packs/case

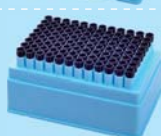
Tip Type	Max Volume	Tip Color	Rack	Packaging	GEB Cat#
 Non-Filtered, Non-Sterilized	200µl	Black		Racked	AT200P-9-X
 Low Retention Non-Filtered, Non-Sterilized	200µl	Black		Racked	AT200P-9-X-LB
Non-Filtered, Pre-Sterilized	200µl	Black		Racked	AT200P-9-XS
 Low Retention Non-Filtered, Pre-Sterilized	200µl	Black		Racked	AT200P-9-XS-LB
 Filtered, Pre-Sterilized	175µl	Black		Racked	AF200P-9-XS
 Low Retention Filtered, Pre-Sterilized	175µl	Black		Racked	AF200P-9-XS-LB

Tips Compatible for  
**Olympus**  
**ROBOTIC TIPS**



Format: 140-tip format  
 Tip Volume range selection: 1000µl  
 Material: Natural Polypropylene  
 Alternatives:  with/without aerosol-barrier filter  
                    Pre-Sterilized/Non-Sterilized  
                    Low Retention/Standard  
 Certified: DNase-Free, RNase-Free, Endotoxin-Safe



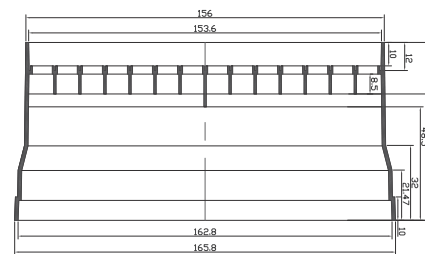
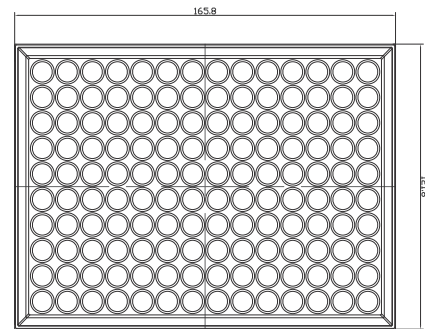





Material: Number 5 Polypropylene

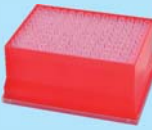

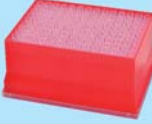
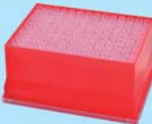
1000µl | Compatible Head: ATO96

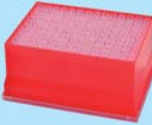

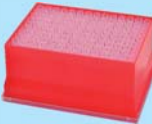
Packaging Specification:  
140 tips per rack, 10 racks per pack, 4 packs per case

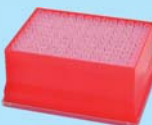
Tip Type	Max Volume	Tip Color	Rack	Packaging	GEB Cat#
 Non-Filtered, Non-Sterilized	1000µl	Natural		Racked	AT01M0-4-N
 Low Retention Non-Filtered, Non-Sterilized	1000µl	Natural		Racked	AT01M0-4-N-LB
Non-Filtered, Pre-Sterilized	1000µl	Natural		Racked	AT01M0-4-N-S
 Low Retention Non-Filtered, Pre-Sterilized	1000µl	Natural		Racked	AT01M0-4-N-S-LB
 Filtered, Pre-Sterilized	1000µl	Natural		Racked	AF01M0-4-N-S
 Low Retention Filtered, Pre-Sterilized	1000µl	Natural		Racked	AF01M0-4-N-S-LB

# Blue GEB, Your Better Choice

Tips Compatible for  
**Olympus**  
ROBOTIC TIPS



Format: 140-tip format  
Tip Volume range selection: 1000µl  
Material: Conductive Polypropylene  
Alternatives:  with/without aerosol-barrier filter  
                   Pre-Sterilized/Non-Sterilized  
                   Low Retention/Standard  
Certified: DNase-Free, RNase-Free, Endotoxin-Safe



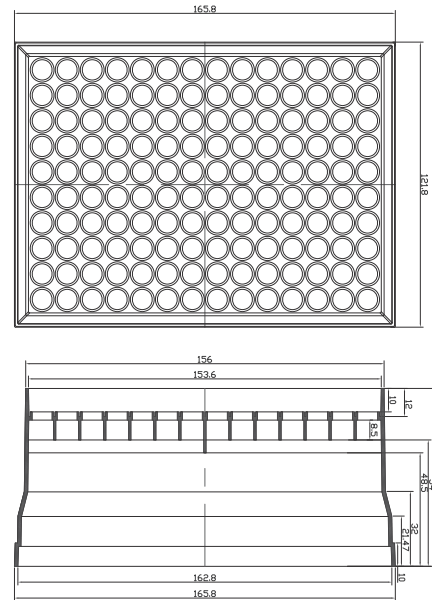





Material: Number 5 Polypropylene

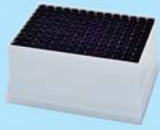

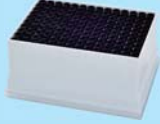
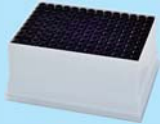
1000µl | Compatible Head: AP-96

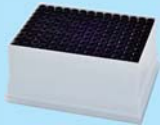

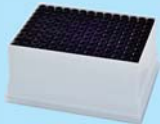
**Packaging Specification:**  
140 tips/rack, 10 racks/pack, 5 packs/case

Tip Type	Max Volume	Tip Color	Rack	Packaging	GEB Cat#
 Non-Filtered, Non-Sterilized	1000µl	Black		Racked	AT01M0-4-X
 Low Retention Non-Filtered, Non-Sterilized	1000µl	Black		Racked	AT01M0-4-X-LB
Non-Filtered, Pre-Sterilized	1000µl	Black		Racked	AT01M0-4-XS
 Low Retention Non-Filtered, Pre-Sterilized	1000µl	Black		Racked	AT01M0-4-XS-LB
 Filtered, Pre-Sterilized	1000µl	Black		Racked	AF01M0-4-XS
 Low Retention Filtered, Pre-Sterilized	1000µl	Black		Racked	AF01M0-4-XS-LB

Tips Compatible for  
**Rainin**  
**ROBOTIC TIPS**



Format: 96-tip format  
 Tip Volume range selection: 800µl  
 Material: Conductive Polypropylene  
 Alternatives:  with/without aerosol-barrier filter  
                    Pre-Sterilized/Non-Sterilized  
                    Low Retention/Standard  
 Certified: DNase-Free, RNase-Free, Endotoxin-Safe

Material: Number 5 Polypropylene

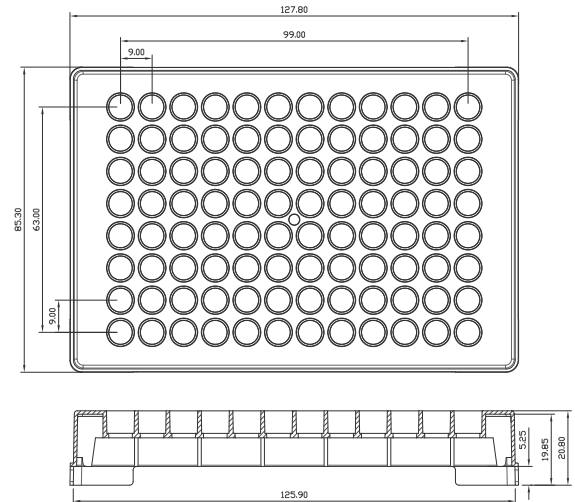

800µl | Compatible Head: AP-96



**Packaging Specification:**  
96 tips/rack, 10 racks/pack, 5 packs/case

Tip Type	Max Volume	Tip Color	Rack	Packaging	GEB Cat#
Non-Filtered, Non-Sterilized	800µl	Natural		Racked	AT800R-9-X
Low Retention Non-Filtered, Non-Sterilized	800µl	Natural		Racked	AT800R-9-X-LB
Non-Filtered, Pre-Sterilized	800µl	Natural		Racked	AT800R-9-XS
Low Retention Non-Filtered, Pre-Sterilized	800µl	Natural		Racked	AT800R-9-XS-LB
Filtered, Pre-Sterilized	800µl	Natural		Racked	AF800R-9-XS
Low Retention Filtered, Pre-Sterilized	800µl	Natural		Racked	AF800R-9-XS-LB



# Blue GEB, Your Better Choice

Tips Compatible for  
**Zymark®**, **Zymark Rapidplate/Sciclone**  
**Fit Caliper®**, **Tecan TEMO**, **Aquarius** and **GenMate**  
**ROBOTIC TIPS**



Format: 96-tip format  
 Tip Volume range selection: 50µl  
 Material: Natural Polypropylene  
 Alternatives:  with/without aerosol-barrier filter  
                    Pre-Sterilized/Non-Sterilized  
                    Low Retention/Standard  
 Certified: DNase-Free, RNase-Free, Endotoxin-Safe

Material: Number 5 Polypropylene

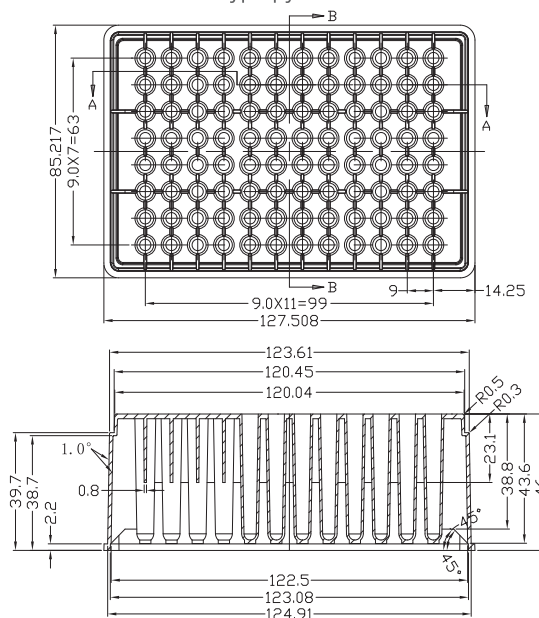

50µl | Compatible Head: AZT-96



### Packaging Specification:

(1) Refillable Rack: 96 tips per rack, 8 racks per stack, 10 stacks per case  
 (2) Racked: 96 tips per rack

Tip Type	Max Volume	Tip Color	Rack	Packaging	GEB Cat#
 Non-Filtered, Non-Sterilized	50µl	Natural		Racked	AT050Z-9-N
 Low Retention Non-Filtered, Non-Sterilized	50µl	Natural		Racked	AT050Z-9-N-LB
 Non-Filtered, Pre-Sterilized	50µl	Natural		Racked	AT050Z-9-N-S
 Low Retention Non-Filtered, Pre-Sterilized	50µl	Natural		Racked	AT050Z-9-N-S-LB
 Filtered, Pre-Sterilized	50µl	Natural		Racked	AF050Z-9-N-S
 Low Retention Filtered, Pre-Sterilized	50µl	Natural		Racked	AF050Z-9-N-S-LB
 Non-Filtered, Non-Sterilized	50µl	Natural		Refillable Rack	AT050Z-9N-N
 Low Retention Non-Filtered, Non-Sterilized	50µl	Natural		Refillable Rack	AT050Z-9N-N-LB

Tips Compatible for  
**Zymark® , Zymark Rapidplate/Sciclone  
Fit Caliper®, Tecan TEMO, Aquarius and GenMate  
ROBOTIC TIPS**



Format:96-tip format  
Tip Volume range selection: 200µl  
Material:Natural Polypropylene  
Alternatives: ● with/without aerosol-barrier filter  
● Pre-Sterilized/Non-Sterilized  
● Low Retention/Standard  
Certified:DNase-Free, RNase-Free, Endotoxin-Safe

Material: Number 5 Polypropylene

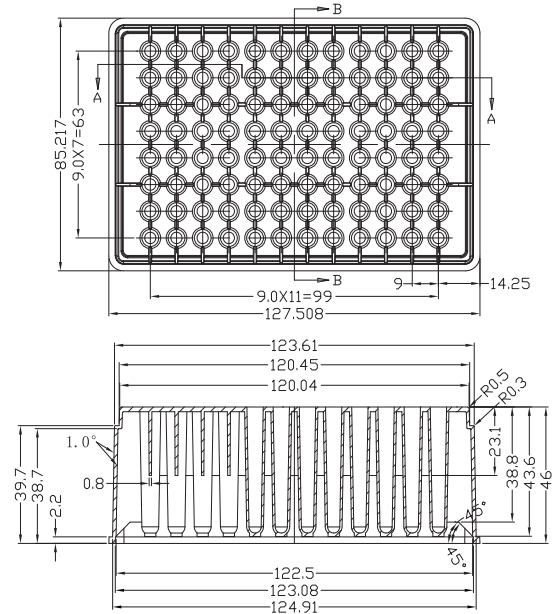

200µl | Compatible Head: AP-96



**Packaging Specification:**

(1)Refillable Rack:96 tips per rack, 8 racks per stack, 10 stacks per case (2)Racked: 96 tips per rack

Tip Type	Max Volume	Tip Color	Rack	Packaging	GEB Cat#
 Non-Filtered, Non-Sterilized	200µl	Natural		Racked	AT200Z-9-N
 Low Retention Non-Filtered, Non-Sterilized	200µl	Natural		Racked	AT200Z-9-N-S-LB
Non-Filtered, Pre-Sterilized	200µl	Natural		Racked	AT200Z-9-N-S
 Low Retention Non-Filtered, Pre-Sterilized	200µl	Natural		Racked	AT200Z-9-N-LB
 Filtered, Pre-Sterilized	180µl	Natural		Racked	AF200Z-9-N-S
 Low Retention Filtered, Pre-Sterilized	180µl	Natural		Racked	AF200Z-9-N-S-LB
 Non-Filtered, Non-Sterilized	200µl	Natural		Refillable Rack	AT200Z-9N-N
 Low Retention Non-Filtered, Non-Sterilized	200µl	Natural		Refillable Rack	AT200Z-9N-N-LB

# Blue GEB, Your Better Choice







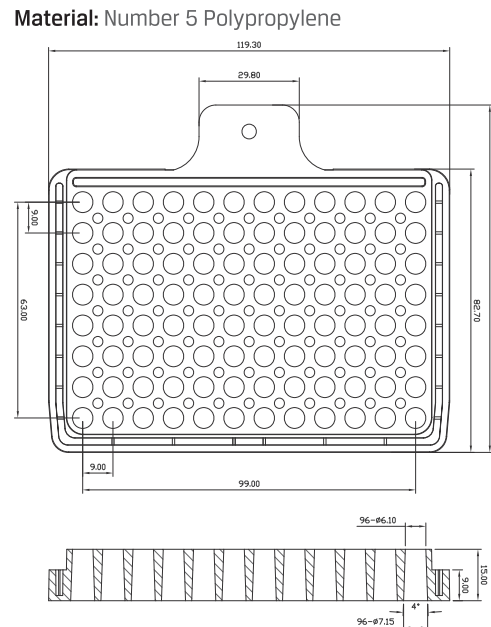

Tips Compatible for  
**Cybi® , CyBi® -Well Family, Cybi® -Well; Cybi® -Well Vario; Cybi® -WellFlex; Cybi® -WellFlex Vario**  
**ROBOTIC TIPS**



Format:96-tip format  
 Tip Volume range selection: 50µl  
 Material:Natural Polypropylene  
 Alternatives:⊙ with/without aerosol-barrier filter  
                   ⊙ Pre-Sterilized/Non-Sterilized  
                   ⊙ Low Retention/Standard  
 Certified:DNase-Free, RNase-Free, Endotoxin-Safe



50µl | Compatible Head: AT096 Packaging Specification: 96 tips per rack, 10 racks per pack, 5 packs per case

Tip Type	Max Volume	Tip Color	Rack	Packaging	GEB Cat#
 Non-Filtered, Non-Sterilized	50µl	Natural		Racked	AT050CY-9-N
 Low Retention Non-Filtered, Non-Sterilized	50µl	Natural		Racked	AT050CY-9-N-LB
Non-Filtered, Pre-Sterilized	50µl	Natural		Racked	AT050CY-9-N-S
 Low Retention Non-Filtered, Pre-Sterilized	50µl	Natural		Racked	AT050CY-9-N-S-LB
 Filtered, Pre-Sterilized	50µl	Natural		Racked	AF050CY-9-N-S
 Low Retention Filtered, Pre-Sterilized	50µl	Natural		Racked	AF050CY-9-N-S-LB

Tips Compatible for  
**Cybi® , CyBi® -Well Family, Cybi® -Well; Cybi® -Well Vario; Cybi® -WellFlex; Cybi® -WellFlex Vario**  
**ROBOTIC TIPS**



Format:96-tip format  
Tip Volume range selection: 250µl  
Material:Natural Polypropylene  
Alternatives:  with/without aerosol-barrier filter  
                   Pre-Sterilized/Non-Sterilized  
                   Low Retention/Standard  
Certified:DNase-Free, RNase-Free, Endotoxin-Safe



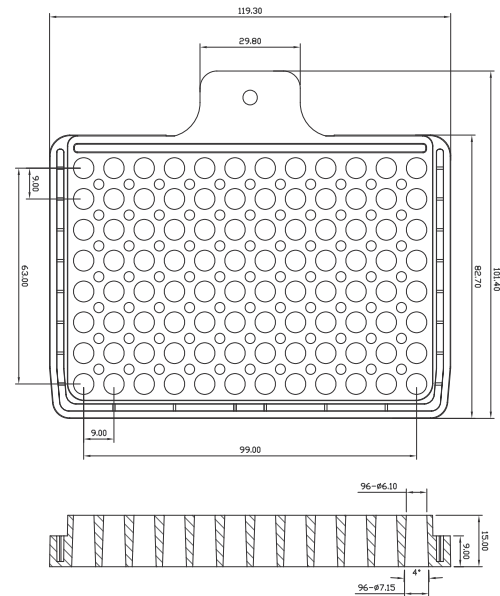



Material: Number 5 Polypropylene



**250µl | Compatible Head: AP-96**



**Packaging Specification:**  
96 tips/rack, 10 racks/pack, 5 packs/case

Tip Type	Max Volume	Tip Color	Rack	Packaging	GEB Cat#
 Non-Filtered, Non-Sterilized	250µl	Natural		Racked	AT250CY-9-N
 Low Retention Non-Filtered, Non-Sterilized	250µl	Natural		Racked	AT250CY-9-N-LB
Non-Filtered, Pre-Sterilized	250µl	Natural		Racked	AT250CY-9-N-S
 Low Retention Non-Filtered, Pre-Sterilized	250µl	Natural		Racked	AT250CY-9-N-S-LB
 Filtered, Pre-Sterilized	250µl	Natural		Racked	AF250CY-9-N-S
 Low Retention Filtered, Pre-Sterilized	250µl	Natural		Racked	AF250CY-9-N-S-LB

# Blue GEB, Your Better Choice

Tips Compatible for  
**HITACHI**  
ROBOTIC TIPS

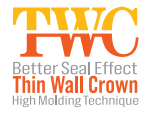

## Innovative Robotic Tips

- Virgin PP/TPU Dual Resin Molding
- Super elasticity , Optimum Leakproofness
- Reduce Robotic Head operating force
- Prolong Robotic Head life cycle

2500µl | Compatible Head: AT096



**Packaging Specification:**  
96 tips per rack, 10 racks per pack, 5 packs per case

Tip Type	Max Volume	Tip Color	Packaging	GEB Cat#
 Non-Filtered, Non-Sterilized		Blue	Bulk	AT02MHT-B-B

# PCR Series

## Optimum Accuracy and Reliability

Solution for Accuracy and Reliability of PCR Results

Gene Diagnosis • Drug Discovery • Genomic Research

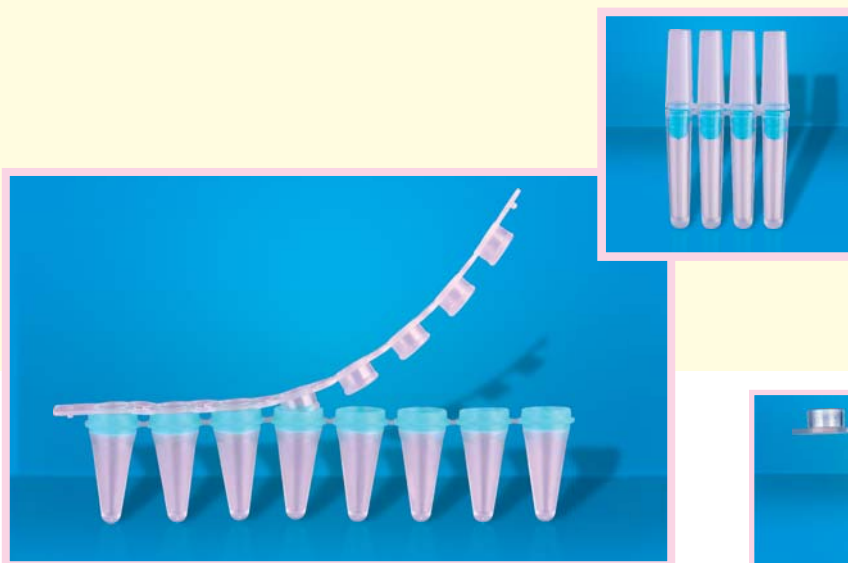

### GEB Exclusive DRM Dual Resin PCR series

**DUAL RESIN PCR** products provide greater ease of closure and increased seal integrity; "ZERO" evaporation and reduced "edge-effect" prevent aerosol contaminants and subsequent false positive PCR results.



### GEB R&R Low Retention PCR series

GEB's **R&R** Low Retention PCR Tubes/Plate provide you a super uniformity and consistent retentionless surface to create a **RETENTIONLESS RECOVERY** effect during your samples and reagents handling.

GEB keeps researching and developing technique for less sample retention and less electrostatic violence and better leakproofness so as to guarantee the PCR result accurate.



Minimize sample and reagent retention  
Guarantee reaction system accuracy and precision



Provide a better seal effect  
Be more flexible to fit robotic pipetting head or manual pipettors

# Blue GEB, Your Better Choice



## Single PCR tube, 8 Strip tubes and PCR Plate Caps and Closures



### 0.2ml-flat cap



**Packaging Specification:**  
1000 tubes per bag, 10 bags per case

Type	Volume	Color	Packaging	GEB Cat#
 Thin Wall, Flat Cap	0.2ml	Natural	Bulk	PC0201-B-N
 Low Retention, Thin Wall, Flat Cap	0.2ml	Natural	Bulk	PC0201-B-N-LB

### 0.1ml Dual Resin 8-strip PCR tubes, without caps



**Packaging Specification:**  
8 tubes per strip, 125 strips per bag, 10 bags per case

Type	Volume	Color	Packaging	GEB Cat#
	0.1ml	Natural	Bulk	PC0108-B-TS

### 0.2ml 8-Strip PCR tube, without caps



**Packaging Specification:**  
8 tubes per strip, 125 strips per bag, 10 bags per case

Type	Volume	Color	Packaging	GEB Cat#
 Thin Wall, 8 strip without Cap	0.2ml	Natural	Bulk	PC0208-B-N

### Dual Resin 4-strip PCR tubes, without caps



**Packaging Specification:**  
8 tubes per strip, 125 strips per bag, 10 bags per case

Type	Volume	Color	Packaging	GEB Cat#
	50 µ l	Natural	Bulk	PC0504-R-TS

### Dual Resin 4-strip PCR tube,Caps



**Packaging Specification:**  
8 tubes per strip, 125 strips per bag, 10 bags per case

Type	Color	Packaging	GEB Cat#
	Natural	Bulk	PC004-R-TS



## Single PCR tube, 8 Strip tubes and PCR Plate Caps and Closures

### 0.1ml Dual Resin 96-strip PCR tubes, without caps



**Packaging Specification:**  
96 tubes per rack, 10 racks per bag, 5 bags per case

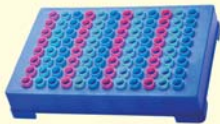

Type	Volume	Color	Packaging	GEB Cat#
	0.1ml	Natural	Racked	PC0108-9-TS

### 0.2ml Dual Resin 96-strip PCR tubes, without caps



**Packaging Specification:**  
96 tubes per rack, 10 racks per bag, 5 bags per case



Type	Volume	Color	Packaging	GEB Cat#
	0.2ml	Natural	Racked	PC0208-9-TS

### 0.1ml 12-strip PCR tubes, without caps



**Packaging Specification:**  
12 tubes per strip, 125 strips per bag, 10 bags per case



Type	Volume	Color	Packaging	GEB Cat#
	0.1ml	Natural	Bulk	PC0112-B-N

### 0.2ml 12-strip PCR tubes, without caps



**Packaging Specification:**  
12 tubes per strip, 125 strips per bag, 10 bags per case



Type	Volume	Color	Packaging	GEB Cat#
	0.2ml	Natural	Bulk	PC0212-B-N

### 0.2ml 96-well PCR Plate



**Packaging Specification:**  
10 plates per unit. 5 units per case



Type	Volume	Color	Packaging	GEB Cat#
Half Skirt, PP	0.2ml	Natural	Bulk	PC20HS-9-N



No Skirt, PP	0.2ml	Natural	Bulk	PC20NS-9-N
--------------	-------	---------	------	------------



# Blue GEB, Your Better Choice

## Single PCR tube, 8 Strip tubes and PCR Plate Caps and Closures



### 0.2ml 96-well PCR Plate, PP



**Packaging Specification:**  
10 plates per unit. 5 units per case

	Type	Max Volume	Color	Packaging	GEB Cat#
	Half Skirt	0.2ml	Black	Bulk	PC20HS-9-X-RID
	Half Skirt	0.2ml	White	Bulk	PC20HS-9-W-RID

### 0.1ml 96-well PCR Plate, PP



**Packaging Specification:**  
10 plates per unit. 5 units per case

	Type	Max Volume	Color	Packaging	GEB Cat#
	Full Skirt	0.1ml	Natural	Bulk	PC10FS-9-N
	Half Skirt, fit Light Cycler, fit Roche	0.1ml	White	Bulk	PC10HS-9-W-LC
	No Skirt	0.1ml	White	Bulk	PC10NS-9-W

### 40µl 384-well PCR Plate, PP



**Packaging Specification:**  
10 plates per unit. 5 units per case

	Type	Max Volume	Color	Packaging	GEB Cat#
	Full Skirt	40 µ l	Black	Bulk	PC04FS-3-X-RID
	Full Skirt	40 µ l	White	Bulk	PC04FS-3-W-RID



## Single PCR tube, 8 Strip tubes and PCR Plate Caps and Closures

### 0.2ml 8-Strip Flat Caps



**Packaging Specification:**  
8 caps per strip, 125 strips per bag, 10 bags per case



#### Compatibility

fit 0.2ml 8-Strip PCR tubes(GEB Cat# PC0208-B-N, PC10FS-9-N, PC10HS-9-W-LC)

#### Packaging

Bulk

#### GEB Cat#

PCQ028-B-N

### 0.1ml/0.2ml 12-Strip Flat Caps



**Packaging Specification:**  
12 caps per strip, 125 strips per bag, 10 bags per case



#### Compatibility

fit 0.2ml 12-Strip PCR tubes(GEB Cat# PC0208-B-N, PC10FS-9-N, PC10HS-9-W-LC)

#### Packaging

Bulk

#### GEB Cat#

PCQ0112-B-N

### 0.1ml 96-well PCR Plate, fit ABI



**Packaging Specification:**  
10 mats per bag, 5 bags per case



#### Type

Low Profile

#### Max Volume

0.1ml

#### Color

Natural

#### Packaging

Bulk

#### GEB Cat#

PC10HS-9-LP-N-AB

### 0.2ml 96-well PCR Plate, fit ABI



**Packaging Specification:**  
10 mats per bag, 5 bags per case



#### Type

Elevated Skirt

#### Max Volume

0.2ml

#### Color

Natural

#### Packaging

Bulk

#### GEB Cat#

PC20ES-9-N-AB

### Film for PCR Plate



**Packaging Specification:**  
100 films per pack, 5 packs per case

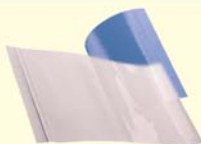

#### Compatibility

fit 96/384-well plate

#### Color

Natural

#### Packaging

Bulk

#### GEB Cat#

PCOMAT-9-N

**Blue GEB, Your Better Choice**

# Universal Fit Pipette Tips

## Better Tips for Improved Flexibility

Our innovation guarantees your pipetting with improved accuracy and flexibility



### GEB TWC THIN WALL CROWN

Pipette tips provide you a better seal effect for pipettors, and are more flexible and require less insertion force.

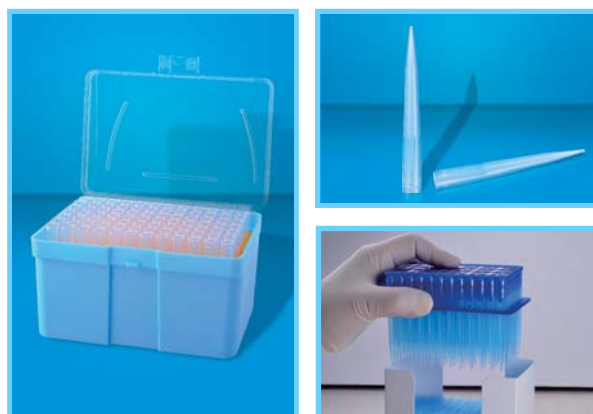

GEB produces pipette tips with exclusive techniques of TWC Thin Wall Crown and R&R Low Retention so that the cooperation between pipettor and tip is optimized.

The liquid handling will be more accurate and flexible with GEB pipette tips.



Provide a safer double safe cap lock system  
Provide a flexible half-lock position to prevent liquid evaporation during reagents pipetting



Minimize sample and reagent retention  
Guarantee reaction system accuracy and precision

Tips Compatible for a wide range of pipettors  
**Universal Fit**  
**Pipette Tips without Aerosol Barrier**

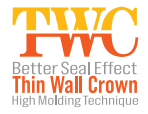

**10µl, with graduation marks at 2µl and 10µl**

	Type	Volume	Color	Packaging	Packaging Specification	GEB Cat#
	Non-Sterilized	0.5-10µl	Natural	Bulk	1000 tips per bag 20 bags per case	PT0010-B-N
	Low Retention Non-Sterilized	0.5-10µl	Natural	Bulk	1000 tips per bag 20 bags per case	PT0010-B-N-LB
	Non-Sterilized	0.5-10µl	Natural	Racked	96 tips per rack 10 racks per pack, 5 packs per case	PT0010-9-N
	Low Retention Non-Sterilized	0.5-10µl	Natural	Racked	96 tips per rack 10 racks per pack, 5 packs per case	PT0010-9-N-LB
	Non-Sterilized	0.5-10µl	Natural	Refillable Rack	96 tips per rack 10 racks per stack, 10 stacks per case	PT0010-E-N
	Low Retention Non-Sterilized	0.5-10µl	Natural	Refillable Rack	96 tips per rack 10 racks per stack, 10 stacks per case	PT0010-E-N-LB
	Pre-Sterilized	0.5-10µl	Natural	Racked	96 tips per rack 10 racks per pack, 5 packs per case	PT0010-9-N-S
	Low Retention Pre-Sterilized	0.5-10µl	Natural	Racked	96 tips per rack 10 racks per pack, 5 packs per case	PT0010-9-N-S-LB

**200µl, with graduation marks at 10µl, 50µl and 100µl**

	Type	Volume	Color	Packaging	Packaging Specification	GEB Cat#
	Non-Sterilized	10-200µl	Yellow	Bulk	1000 tips per bag 20 bags per case	PT0200-B-Y
	Low Retention Non-Sterilized	10-200µl	Yellow	Bulk	1000 tips per bag 20 bags per case	PT0200-B-Y-LB
	Non-Sterilized	10-200µl	Yellow	Racked	96 tips per rack 10 racks per pack, 5 packs per case	PT0200-9-Y
	Low Retention Non-Sterilized	10-200µl	Yellow	Racked	96 tips per rack 10 racks per pack, 5 packs per case	PT0200-9-Y-LB
	Non-Sterilized	10-200µl	Yellow	Refillable Rack	96 tips per rack 10 racks per stack, 10 stacks per case	PT0200-E-Y
	Low Retention Non-Sterilized	10-200µl	Yellow	Refillable Rack	96 tips per rack 10 racks per stack, 10 stacks per case	PT0200-E-Y-LB
	Pre-Sterilized	10-200µl	Yellow	Racked	96 tips per rack 10 racks per pack, 5 packs per case	PT0200-9-YS
	Low Retention Pre-Sterilized	10-200µl	Yellow	Racked	96 tips per rack 10 racks per pack, 5 packs per case	PT0200-9-YS-LB



# Blue GEB, Your Better Choice

Tips Compatible for a wide range of pipettors







## Universal Fit Pipette Tips without Aerosol Barrier



### 300µl, with graduation marks at 10µl, 50µl and 100µl

	Type	Volume	Color	Packaging	Packaging Specification	GEB Cat#
	Non-Sterilized	10-300 µl	Natural	Bulk	1000 tips per bag 20 bags per case	PT0300-B-N
	Low Retention Non-Sterilized	10-300 µl	Natural	Bulk	1000 tips per bag 20 bags per case	PT0300-B-N-LB
	Non-Sterilized	10-300 µl	Natural	Racked	96 tips per rack 10 racks per pack, 5 packs per case	PT0300-9-N
	Low Retention Non-Sterilized	10-300 µl	Natural	Racked	96 tips per rack 10 racks per pack, 5 packs per case	PT0300-9-N-LB
	Non-Sterilized	10-300 µl	Natural	Refillable Rack	96 tips per rack 10 racks per stack, 10 stacks per case	PT0300-E-N
	Low Retention Non-Sterilized	10-300 µl	Natural	Refillable Rack	96 tips per rack 10 racks per stack, 10 stacks per case	PT0300-E-N-LB
	Pre-Sterilized	10-300 µl	Natural	Racked	96 tips per rack 10 racks per pack, 5 packs per case	PT0300-9-N-S
	Low Retention Pre-Sterilized	10-300 µl	Natural	Racked	96 tips per rack 10 racks per pack, 5 packs per case	PT0300-9-N-S-LB

### 1000µl, with graduation marks at 100µl, 200µl and 500µl







	Type	Volume	Color	Packaging	Packaging Specification	GEB Cat#
	Non-Sterilized	100-1000 µl	Blue	Bulk	1000 tips per bag 5 bags per case	PT1000-B-B
	Low Retention Non-Sterilized	100-1000 µl	Blue	Bulk	1000 tips per bag 5 bags per case	PT1000-B-B-LB
	Non-Sterilized	100-1000 µl	Blue	Rack	96 tips per rack 10 racks per pack, 5 packs per case	PT1000-1-B
	Low Retention Non-Sterilized	100-1000 µl	Blue	Rack	96 tips per rack 10 racks per pack, 5 packs per case	PT1000-1-B-LB
	Non-Sterilized	100-1000 µl	Blue	Refillable Rack	96 tips per rack 5 racks per stack, 10 stacks per case	PT1000-E-B
	Low Retention Non-Sterilized	100-1000 µl	Blue	Refillable Rack	96 tips per rack 5 racks per stack, 10 stacks per case	PT1000-E-B-LB
	Pre-Sterilized	100-1000 µl	Blue	Racked	96 tips per rack 10 racks per pack, 5 packs per case	PT1000-1-BS
	Low Retention Pre-Sterilized	100-1000 µl	Blue	Racked	96 tips per rack 10 racks per pack, 5 packs per case	PT1000-1-BS-LB

Tips Compatible for a wide range of pipettors

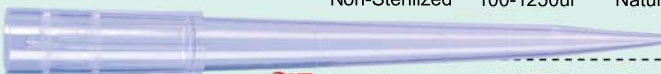
## Universal Fit Pipette Tips without Aerosol Barrier

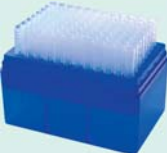

1250µl, with graduation marks at 50µl, 100µl, 200µl and 500µl

	Type	Volume	Color	Packaging	Packaging Specification	GEB Cat#
	Non-Sterilized	100-1250ul	Natural	Bulk	1000 tips per bag 5 bags per case	PT1250-B-N
	 Low Retention Non-Sterilized	100-1250ul	Natural	Bulk	1000 tips per bag 5 bags per case	PT1250-B-N-LB
	Non-Sterilized	100-1250ul	Natural	Racked	96 tips per rack 10 racks per pack, 5 packs per case	PT1250-9-N
	 Low Retention Non-Sterilized	100-1250ul	Natural	Racked	96 tips per rack 10 racks per pack, 5 packs per case	PT1250-9-N-LB
	Non-Sterilized	100-1250ul	Natural	Refillable Rack	96 tips per rack 5 racks per stack, 10 stacks per case	PT1250-E-N
	 Low Retention Non-Sterilized	100-1250ul	Natural	Refillable Rack	96 tips per rack 5 racks per stack, 10 stacks per case	PT1250-E-N-LB
	Pre-Sterilized	100-1250ul	Natural	Racked	96 tips per rack 10 racks per pack, 5 packs per case	PT1250-9-N-S
	 Low Retention Pre-Sterilized	100-1250ul	Natural	Racked	96 tips per rack 10 racks per pack, 5 packs per case	PT1250-9-N-S-LB





# Blue GEB, Your Better Choice

Tips Compatible for a wide range of pipettors





## Universal Fit Pipette Tips with Aerosol Barrier







### 10µl, with graduation marks at 2µl and 10µl

	Type	Volume	Color	Packaging	Packaging Specification	GEB Cat#
	Filtered Non-Sterilized	0.5-10µl	Natural	Bulk	1000 tips per bag 10 bags per case	FT0010-B-N
	 Low Retention Filtered, Non-Sterilized	0.5-10µl	Natural	Bulk	1000 tips per bag 10 bags per case	FT0010-B-N-LB
	Filtered Pre-Sterilized	0.5-10µl	Natural	Racked	96 tips per rack 10 racks per box, 5 boxes per case	FT0010-R-N-S
	 Low Retention Filtered, Pre-Sterilized	0.5-10µl	Natural	Racked	96 tips per rack 10 racks per box, 5 boxes per case	FT0010-R-N-S-LB

### 20µl, with graduation marks at 10µl

	Type	Volume	Color	Packaging	Packaging Specification	GEB Cat#
	Filtered Non-Sterilized	1.0-20µl	Natural	Bulk	1000 tips per bag 10 bags per case	FT0020-B-N
	 Low Retention Filtered, Non-Sterilized	1.0-20µl	Natural	Bulk	1000 tips per bag 10 bags per case	FT0020-B-N-LB
	Filtered Pre-Sterilized	1.0-20µl	Natural	Racked	96 tips per rack 10 racks per box, 5 boxes per case	FT0020-R-N-S
	 Low Retention Filtered, Pre-Sterilized	1.0-20µl	Natural	Racked	96 tips per rack 10 racks per box, 5 boxes per case	FT0020-R-N-S-LB

### 100µl, with graduation marks at 10µl, 50µl and 100µl





	Type	Volume	Color	Packaging	Packaging Specification	GEB Cat#
	Filtered Non-Sterilized	10-100µl	Natural	Bulk	1000 tips per bag 10 bags per case	FT0100-B-N
	 Low Retention Filtered, Non-Sterilized	10-100µl	Natural	Bulk	1000 tips per bag 10 bags per case	FT0100-B-N-LB
	Filtered Pre-Sterilized	10-100µl	Natural	Racked	96 tips per rack 10 racks per box, 5 boxes per case	FT0100-R-N-S
	 Low Retention Filtered, Pre-Sterilized	10-100µl	Natural	Racked	96 tips per rack 10 racks per box, 5 boxes per case	FT0100-R-N-S-LB

Tips Compatible for a wide range of pipettors





## Universal Fit Pipette Tips with Aerosol Barrier







### 200µl, with graduation marks at 10µl, 50µl and 100µl

	Type	Volume	Color	Packaging	Packaging Specification	GEB Cat#
	Filtered Non-Sterilized	10-200µl	Natural	Bulk	1000 tips per bag 10 bags per case	FT0200-B-N
	 Low Retention Filtered, Non-Sterilized	10-200µl	Natural	Bulk	1000 tips per bag 10 bags per case	FT0200-B-N-LB
	Filtered Pre-Sterilized	10-200µl	Natural	Racked	96 tips per rack 10 racks per box, 5 boxes per case	FT0200-R-N-S
	 Low Retention Filtered, Pre-Sterilized	10-200µl	Natural	Racked	96 tips per rack 10 racks per box, 5 boxes per case	FT0200-R-N-S-LB

### 500µl, with graduation marks at 100µl, 200µl and 500µl

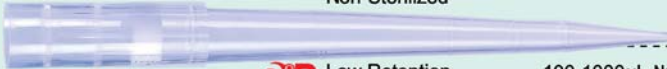
	Type	Volume	Color	Packaging	Packaging Specification	GEB Cat#
	Filtered Non-Sterilized	100-500µl	Natural	Bulk	1000 tips per bag 5 bags per case	FT0500-B-N
	 Low Retention Filtered, Non-Sterilized	100-500µl	Natural	Bulk	1000 tips per bag 5 bags per case	FT0500-B-N-LB
	Filtered Pre-Sterilized	100-500µl	Natural	Racked	96 tips per rack 10 racks per box, 5 boxes per case	FT0500-R-N-S
	 Low Retention Filtered, Pre-Sterilized	100-500µl	Natural	Racked	96 tips per rack 10 racks per box, 5 boxes per case	FT0500-R-N-S-LB

### 1000µl, with graduation marks at 50µl, 100µl, 200µl and 500µl

	Type	Volume	Color	Packaging	Packaging Specification	GEB Cat#
	Filtered Non-Sterilized	100-1000µl	Natural	Bulk	1000 tips per bag 5 bags per case	FT1000-B-N
	 Low Retention Filtered, Non-Sterilized	100-1000µl	Natural	Bulk	1000 tips per bag 5 bags per case	FT1000-B-N-LB
	Filtered Non-Sterilized	100-1000µl	Natural	Racked	96 tips per rack 10 racks per box, 5 boxes per case	FT1000-R-N-S
	 Low Retention Filtered, Pre-Sterilized	100-1000µl	Natural	Racked	96 tips per rack 10 racks per box, 5 boxes per case	FT1000-R-N-S-LB



# Blue GEB, Your Better Choice

## Tubes

### Optimum Sample Handling

Optimum safelocker design, high quality virgin resin, R&R GEB retentionless recovery technique, etc., will help you to optimize your sample handling.

-----  
Proteomics.drug R&D.genomics.HTS



GEB **DUAL SNAPLOCK** system provides you double cap lock for micro centrifuge tubes with a safer leakproofness to protect your reaction systems or biological solutions.

**DUAL SNAPLOCK** system also creates a "half lock" status which provides a flexible position during your multiple reagents processing steps.



Unique O-ring integrated design ensures better protection for your reagents

#### Features:

- Glass-like transparent tubes are also available in seven additional colours.
- Snap-lock tubes are guaranteed to stay closed, even during boiling or autoclaving.
- Withstand up to 20,000 RCF.
- Snap-lock cap ensures efficient seal, yet is still easy to 'flip' open.
- Thin membrane in the caps centre allows easy piercing by syringe needle.
- Certified RNase, DNase, protease and endotoxin-free for total sample integrity.
- Apparent scale identification to facilitate control of liquid volume.



## GEB Microcentrifuge Tubes



### 0.6ml





**Packaging Specification:**  
1000 tubes per bag, 10 bags per case

	Type	Volume	Color	Packaging	GEB Cat#
	Universal, Non-Sterilized	0.6ml	Natural	Bulk	CT0050-B-N
	 Low Retention, Non-Sterilized	0.6ml	Natural	Bulk	CT0050-B-N-LB

### 1.5ml



**Packaging Specification:**  
500 tubes per bag, 10 bags per case

	Type	Volume	Color	Packaging	GEB Cat#
	Universal, Non-Sterilized	1.5 ml	Natural	Bulk	CT0150-B-N
	 Low Retention, Non-Sterilized	1.5 ml	Natural	Bulk	CT0150-B-N-LB
	Universal, Non-Sterilized	1.5 ml	Blue	Bulk	CT0150-B-B
	 Low Retention, Non-Sterilized	1.5 ml	Blue	Bulk	CT0150-B-B-LB
	Universal, Non-Sterilized	1.5 ml	Green	Bulk	CT0150-B-G
	 Low Retention, Non-Sterilized	1.5 ml	Green	Bulk	CT0150-B-G-LB
	Universal, Non-Sterilized	1.5 ml	Orange	Bulk	CT0150-B-O
	 Low Retention, Non-Sterilized	1.5 ml	Orange	Bulk	CT0150-B-O-LB
	Universal, Non-Sterilized	1.5 ml	Red	Bulk	CT0150-B-R
	 Low Retention, Non-Sterilized	1.5 ml	Red	Bulk	CT0150-B-R-LB
	Universal, Non-Sterilized	1.5 ml	Violet	Bulk	CT0150-B-V
	 Low Retention, Non-Sterilized	1.5 ml	Violet	Bulk	CT0150-B-V-LB

# Blue GEB, Your Better Choice



## GEB Microcentrifuge Tubes



### 1.5ml



**Packaging Specification:**  
500 tubes per bag, 10 bags per case

Type	Volume	Color	Packaging	GEB Cat#
Universal, Non-Sterilized	1.5 ml	Amber	Bulk	CT0150-B-A
-----				
 Low Retention, Non-Sterilized	1.5 ml	Amber	Bulk	CT0150-B-A-LB
-----				
Universal, Non-Sterilized	1.5 ml	Yellow	Bulk	CT0150-B-Y
-----				
 Low Retention, Non-Sterilized	1.5 ml	Yellow	Bulk	CT0150-B-Y-LB

### 2.0ml



**Packaging Specification:**  
500 tubes per bag, 10 bags per case





Type	Volume	Color	Packaging	GEB Cat#
Universal, Non-Sterilized	2.0ml	Natural	Bulk	CT0200-B-N
-----				
 Low Retention, Non-Sterilized	2.0ml	Natural	Bulk	CT0200-B-N-LB



## Screw Cap Tubes



**Packaging Specification:**  
500 tubes per bag, 8 bags per case



	Volume	Description	Color	GEB Cat#	
	0.6ml	individual-bottom	Natural	SCT060-C-ST-N	
	0.6ml	individual-bottom	Blue	SCT060-C--ST-B	
	0.6ml	individual-bottom	Green	SCT060-C--ST-G	
	0.6ml	individual-bottom	Orange	SCT060-C--ST-O	
	0.6ml	individual-bottom	Red	SCT060-C--ST-R	
	0.6ml	individual-bottom	Violet	SCT060-C--ST-V	
	0.6ml	individual-bottom	Amber	SCT060-C--ST-A	
	0.6ml	individual-bottom	Yellow	SCT060-C--ST-Y	
 	1.5ml	V-bottom	Natural	SCT150-C-N	
	1.5ml	V-bottom	Blue	SCT150-C-B	
	1.5ml	V-bottom	Green	SCT150-C-G	
	1.5ml	V-bottom	Orange	SCT150-C-O	
	1.5ml	V-bottom	Red	SCT150-C-R	
	1.5ml	V-bottom	Violet	SCT150-C-V	
	1.5ml	V-bottom	Amber	SCT150-C-A	
	1.5ml	V-bottom	Yellow	SCT150-C-Y	
	1.5ml	individual-bottom	Natural	SCT150-C-ST-N	
	1.5ml	individual-bottom	Blue	SCT150-C--ST-B	
	1.5ml	individual-bottom	Green	SCT150-C--ST-G	
	1.5ml	individual-bottom	Orange	SCT150-C--ST-O	
	1.5ml	individual-bottom	Red	SCT150-C--ST-R	
	1.5ml	individual-bottom	Violet	SCT150-C--ST-V	
	1.5ml	individual-bottom	Amber	SCT150-C--ST-A	
	1.5ml	individual-bottom	Yellow	SCT150-C--ST-Y	
		2.0ml	individual-bottom	Natural	SCT200-C-ST-N
		2.0ml	individual-bottom	Blue	SCT200-C--ST-B
2.0ml		individual-bottom	Green	SCT200-C--ST-G	
2.0ml		individual-bottom	Orange	SCT200-C--ST-O	
2.0ml		individual-bottom	Red	SCT200-C--ST-R	
2.0ml		individual-bottom	Violet	SCT200-C--ST-V	
2.0ml		individual-bottom	Amber	SCT200-C--ST-A	
2.0ml		individual-bottom	Yellow	SCT200-C--ST-Y	

# Blue GEB, Your Better Choice

## Screw Cap Tubes



**Packaging Specification:**  
500 tubes per bag, 8 bags per case

	Volume	Description	Color	GEB Cat#	
	0.6ml	individual-bottom	Natural	SCT060-C-ST-LP-N	
	0.6ml	individual-bottom	Blue	SCT060-C-ST-LP-B	
	0.6ml	individual-bottom	Green	SCT060-C-ST-LP-G	
	0.6ml	individual-bottom	Orange	SCT060-C-ST-LP-O	
	0.6ml	individual-bottom	Red	SCT060-C-ST-LP-R	
	0.6ml	individual-bottom	Violet	SCT060-C-ST-LP-V	
	0.6ml	individual-bottom	Amber	SCT060-C-ST-LP-A	
	0.6ml	individual-bottom	Yellow	SCT060-C-ST-LP-Y	
	1.5ml	V-bottom	Natural	SCT150-C-LP-N	
	1.5ml	V-bottom	Blue	SCT150-C-LP-B	
	1.5ml	V-bottom	Green	SCT150-C-LP-G	
	1.5ml	V-bottom	Orange	SCT150-C-LP-O	
	1.5ml	V-bottom	Red	SCT150-C-LP-R	
	1.5ml	V-bottom	Violet	SCT150-C-LP-V	
	1.5ml	V-bottom	Amber	SCT150-C-LP-A	
	1.5ml	V-bottom	Yellow	SCT150-C-LP-Y	
	1.5ml	individual-bottom	Natural	SCT150-C-ST-LP-N	
	1.5ml	individual-bottom	Blue	SCT150-C-ST-LP-B	
	1.5ml	individual-bottom	Green	SCT150-C-ST-LP-G	
	1.5ml	individual-bottom	Orange	SCT150-C-ST-LP-O	
	1.5ml	individual-bottom	Red	SCT150-C-ST-LP-R	
	1.5ml	individual-bottom	Violet	SCT150-C-ST-LP-V	
	1.5ml	individual-bottom	Amber	SCT150-C-ST-LP-A	
	1.5ml	individual-bottom	Yellow	SCT150-C-ST-LP-Y	
		2.0ml	individual-bottom	Natural	SCT200-C-ST-LP-N
		2.0ml	individual-bottom	Blue	SCT200-C-ST-LP-B
2.0ml		individual-bottom	Green	SCT200-C-ST-LP-G	
2.0ml		individual-bottom	Orange	SCT200-C-ST-LP-O	
2.0ml		individual-bottom	Red	SCT200-C-ST-LP-R	
2.0ml		individual-bottom	Violet	SCT200-C-ST-LP-V	
2.0ml		individual-bottom	Amber	SCT200-C-ST-LP-A	
2.0ml		individual-bottom	Yellow	SCT200-C-ST-LP-Y	

## GEB Tube Racks







### 50 well sample tube Racks

Material: polycarbonate



**Packaging Specification:**  
5 racks/bag, 20 bags/case

	Color	Packaging	GEB Cat#	
<ul style="list-style-type: none"> <li>○ Holds 50 1.5/2.0 ml micro and screw cap tubes, and cryogenic storage tubes</li> <li>○ Resistant to lab chemicals and low temperature below -80°C</li> <li>○ Good Tolerance to high temperature and high pressure</li> </ul>		Black	Bulk	CTR-5-X
		Red	Bulk	CTR-5-R
		Green	Bulk	CTR-5-G
		Yellow	Bulk	CTR-5-Y
		Blue	Bulk	CTR-5-B

### 100 well sample tube Racks

Material: polycarbonate



**Packaging Specification:**  
5 racks/stack, 16 stacks/case

	Color	Packaging	GEB Cat#	
<ul style="list-style-type: none"> <li>○ Holds 100 1.5/2.0 ml micro and screw cap tubes, and cryogenic storage tubes</li> <li>○ Resistant to lab chemicals and low temperature below -80°C</li> <li>○ Good Tolerance to high temperature and high pressure</li> </ul>		Black	Bulk	CTR-10-X

# Blue GEB, Your Better Choice

## GEB Tube Racks



**81 well sample tube Racks**  
Material: polycarbonate



**Packaging Specification:**  
5 rack/bag, 16 bags/case

	Color	Packaging	GEB Cat#
	White	Bulk	CTR-8-W
	Red	Bulk	CTR-8-R
	Green	Bulk	CTR-8-G
	Yellow	Bulk	CTR-8-Y
	Blue	Bulk	CTR-8-B
	Dark Blue	Bulk	CTR-8-DB
	Purple	Bulk	CTR-8-P
	Orange	Bulk	CTR-8-O



- Holds 81 1.5/2.0 ml micro and screw cap tubes, and cryogenic storage tubes
- Resistant to lab chemicals and low temperature below -80°C
- Good Tolerance to high temperature and high pressure

## GEB Sample Tubes



### Individual Sample tubes



Type	Volume	Color	Packaging	Packaging Specification	GEB Cat#
Universal, Non-Sterilized	1.2 ml	Natural	Bulk	1000 tubes per bag 10 bags per case	TT1201-B-N
 Low Retention, Non-Sterilized	1.2 ml	Natural	Bulk	1000 tubes per bag 10 bags per case	TT1201-B-N-LB
Universal, Non-Sterilized	1.2 ml	Natural	Racked	96 tubes per rack 10 racks per bag 5 packs per case	TT1201-9-N
 Low Retention, Non-Sterilized	1.2 ml	Natural	Racked	96 tubes per rack 10 racks per bag 5 packs per case	TT1201-9-N-LB
Pre-Sterilized	1.2 ml	Natural	Racked	96 tubes per rack 10 racks per bag 5 packs per case	TT1201-9-N-S
 Low Retention, Pre-Sterilized	1.2 ml	Natural	Racked	96 tubes per rack 10 racks per bag 5 packs per case	TT1201-9-N-S-LB

### 8 Strip Sample tubes



Type	Volume	Color	Packaging	Packaging Specification	GEB Cat#
Universal, Non-Sterilized	1.2 ml	Natural	Bulk	1000 tubes per bag 10 bags per case	TT1208-B-N
 Low Retention, Non-Sterilized	1.2 ml	Natural	Bulk	1000 tubes per bag 10 bags per case	TT1208-B-N-LB
Universal, Non-Sterilized	1.2 ml	Natural	Racked	96 tubes per rack 10 racks per bag 5 packs per case	TT1208-9-N
 Low Retention, Non-Sterilized	1.2 ml	Natural	Racked	96 tubes per rack 10 racks per bag 5 packs per case	TT1208-9-N-LB
Pre-Sterilized	1.2 ml	Natural	Racked	96 tubes per rack 10 racks per bag 5 packs per case	TT1208-9-N-S
 Low Retention, Pre-Sterilized	1.2 ml	Natural	Racked	96 tubes per rack 10 racks per bag 5 packs per case	TT1208-9-N-S-LB

### Seal Mats for Sample tubes (TT1201 & TT1208)

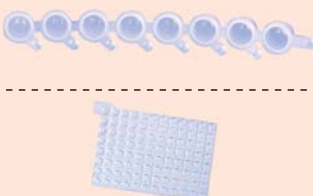

Type	Color	Packaging	Packaging Specification	GEB Cat#
Universal, Non-Sterilized	Natural	Bulk	120 tubes per bag 5 bags per case	TTOMAT-08-N
Universal, Non-Sterilized	Natural	Bulk	10 mats per bag 5 bags per case	TTOMAT-9-N



# Blue GEB, Your Better Choice

## Reservoirs

### Optimum sample collection and storage

GEB exclusive R&R Low Retention technique provides Reservoirs with the optimum sample and reagent saving effect

High Throughput Screening(HTS)•Samples & reagents storage

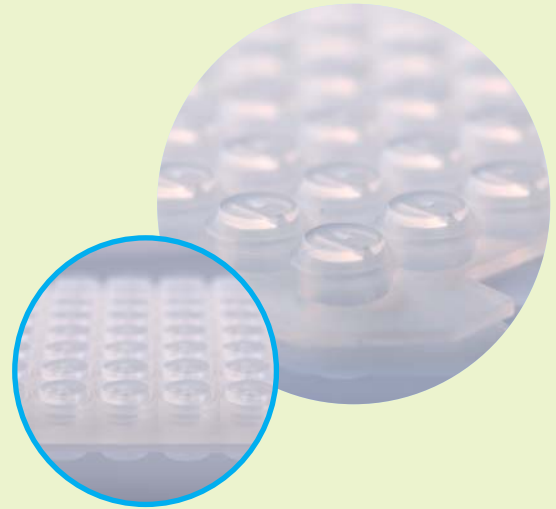

### O-ring

Special designing of O ring which optimizes leakproofness and makes closing and opening more easily.



### GEB R&R Low Retention Technique

GEB's **R&R** liquid reservoirs provide you a maximum saving effect for biological solutions including samples and reagents to guarantee accurate and repeatable results.

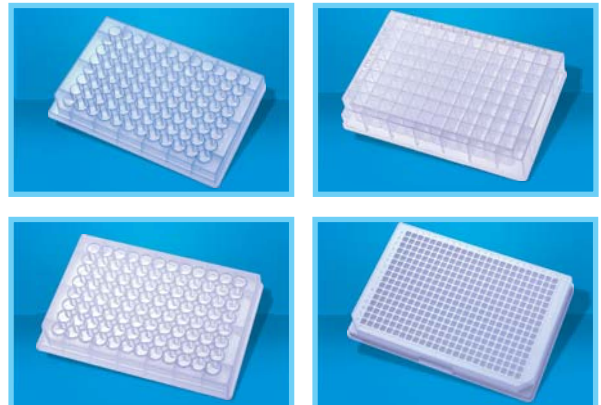

#### Features:

- Polypropylene can be autoclavable at 121°C and it is also long-term stable at -80°C.
- U-shaped and V-shaped bottom outlet series most suitable for mixing and collection of samples.
- Alphabetical sorting and cut angle mark for convenient tracking of samples.
- Applicable to multi-channel pipettors and automation systems.











## Deep Well Plates 96 Round Well Series

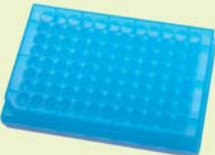

330µl Deep-well plate, Round well-V bottom  
Made of virgin polypropylene

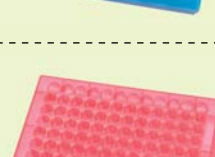









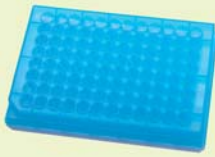

**Packaging Specification:**  
10 plates per pack, 10 packs per case

	Type	Working Volume	Color	Packaging	GEB Cat#
		330µl	Natural	Bulk	DP33VR-9-N
	 Low Retention, Non-Sterilized	330µl	Natural	Bulk	DP33VR-9-N-LB
	Pre-Sterilized	330µl	Natural	Bulk	DP33VR-9-N-S
	 Low Retention, Pre-Sterilized	330µl	Natural	Bulk	DP33VR-9-N-S-LB
	Non-Sterilized	330µl	Blue	Bulk	DP33VR-9-B
	 Low Retention, Non-Sterilized	330µl	Blue	Bulk	DP33VR-9-B-LB
	Pre-Sterilized	330µl	Blue	Bulk	DP33VR-9-BS
	 Low Retention, Pre-Sterilized	330µl	Blue	Bulk	DP33VR-9-BS-LB
	Non-Sterilized	330µl	Red	Bulk	DP33VR-9-R
	 Low Retention, Non-Sterilized	33µl	Red	Bulk	DP33VR-9-R-LB
	Pre-Sterilized	330µl	Red	Bulk	DP33VR-9-RS
	 Low Retention, Pre-Sterilized	330µl	Red	Bulk	DP33VR-9-RS-LB

350µl Deep-well plate, Round well-U bottom  
Made of virgin polypropylene



**Packaging Specification:**  
10 plates per pack, 10 packs per case

	Type	Working Volume	Color	Packaging	GEB Cat#
	Non-Sterilized	350µl	Natural	Bulk	DP35UR-9-N
	 Low Retention, Non-Sterilized	350µl	Natural	Bulk	DP35UR-9-N-LB
	Pre-Sterilized	350µl	Natural	Bulk	DP35UR-9-N-S
	 Low Retention, Pre-Sterilized	350µl	Natural	Bulk	DP35UR-9-N-S-LB
	Non-Sterilize	350µl	Blue	Bulk	DP35UR-9-B
	 Low Retention, Non-Sterilized	350µl	Blue	Bulk	DP35UR-9-B-LB
	Pre-Sterilized	350µl	Blue	Bulk	DP35UR-9-BS
	 Low Retention, Pre-Sterilized	350µl	Blue	Bulk	DP35UR-9-BS-LB
	Non-Sterilized	350µl	Red	Bulk	DP35UR-9-R
	 Low Retention, Non-Sterilized	350µl	Red	Bulk	DP35UR-9-R-LB
	Pre-Sterilized	350µl	Red	Bulk	DP35UR-9-RS
	 Low Retention, Pre-Sterilized	350µl	Red	Bulk	DP35UR-9-RS-LB

# Blue GEB, Your Better Choice



## Deep Well Plates 96 Round Well Series



### 0.8ml Deep-well plate, Round well- **U bottom**, Made of virgin polypropylene





**Packaging Specification:**  
5 plates per pack, 10 packs per case

	Type	Working Volume	Color	Packaging	GEB Cat#
	Non-Sterilized	0.8ml	Natural	Bulk	DP08UR-9-N
	 Low Retention, Non-Sterilized	0.8ml	Natural	Bulk	DP08UR-9-N-LB
	Pre-Sterilized	0.8ml	Natural	Bulk	DP08UR-9-N-S
	 Low Retention, Pre-Sterilized	0.8ml	Natural	Bulk	DP08UR-9-N-S-LB

### 1.2ml Deep-well plate, Round well- **U bottom**, Made of virgin polypropylene



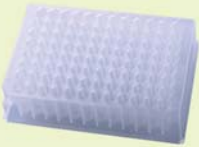

**Packaging Specification:**  
5 plates per pack, 10 packs per case

	Type	Working Volume	Color	Packaging	GEB Cat#
	Non-Sterilized	1.2ml	Natural	Bulk	DP12UR-9-N
	 Low Retention, Non-Sterilized	1.2ml	Natural	Bulk	DP12UR-9-N-LB
	Pre-Sterilized	1.2ml	Natural	Bulk	DP12UR-9-N-S
	 Low Retention, Pre-Sterilized	1.2ml	Natural	Bulk	DP12UR-9-N-S-LB

### 1.3ml Deep-well plate, Round well- **U bottom**, Made of virgin polypropylene



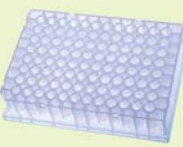

**Packaging Specification:**  
5 plates per pack, 10 packs per case

	Type	Working Volume	Color	Packaging	GEB Cat#
	Non-Sterilized	1.3ml	Natural	Bulk	DP13UR-9I-N
	 Low Retention, Non-Sterilized	1.3ml	Natural	Bulk	DP13UR-9I-N-LB
	Pre-Sterilized	1.3ml	Natural	Bulk	DP13UR-9I-N-S
	 Low Retention, Pre-Sterilized	1.3ml	Natural	Bulk	DP13UR-9I-N-S-LB

### 2.0ml Deep-well plate, Round well- **U bottom**, Made of virgin polypropylene



**Packaging Specification:**  
5 plates per pack, 10 packs per case

	Type	Working Volume	Color	Packaging	GEB Cat#
	Non-Sterilized	2.0ml	Natural	Bulk	DP20UR-9-N
	 Low Retention, Non-Sterilized	2.0ml	Natural	Bulk	DP20UR-9-N-LB
	Pre-Sterilized	2.0ml	Natural	Bulk	DP20UR-9-N-S
	 Low Retention, Pre-Sterilized	2.0ml	Natural	Bulk	DP20UR-9-N-S-LB



## Deep Well Plates 96 Square Well Series



### 1.2ml Deep-well plate, square well-**V** bottom, Made of virgin polypropylene



**Packaging Specification:**  
10 plates per pack, 10 packs per case







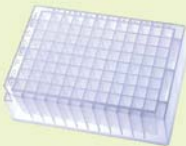

	Type	Working Volume	Color	Packaging	GEB Cat#
	Non-Sterilized	1.2ml	Natural	Bulk	DP12VS-9-N
	 Low Retention, Non-Sterilized	1.2ml	Natural	Bulk	DP12VS-9-N-LB
	Pre-Sterilized	1.2ml	Natural	Bulk	DP12VS-9-N-S
	 Low Retention, Pre-Sterilized	1.2ml	Natural	Bulk	DP12VS-9-N-S-LB

### Compatible Sealing Mates

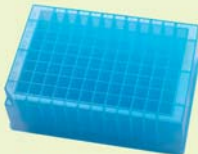
### 2.2ml Deep-well plate, square well-**v** bottom, Made of virgin polypropylene

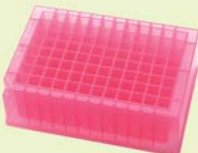

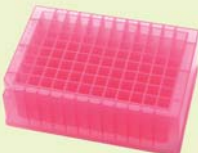
**Packaging Specification:**  
5 plates per pack, 10 packs per case

	Type	Working Volume	Color	Packaging	GEB Cat#
	Non-Sterilized	2.2ml	Natural	Bulk	DP22VS-9-N
	 Low Retention, Non-Sterilized	2.2ml	Natural	Bulk	DP22VS-9-N-LB
	Pre-Sterilized	2.2ml	Natural	Bulk	DP22VS-9-N-S
	 Low Retention, Pre-Sterilized	2.2ml	Natural	Bulk	DP22VS-9-N-S-LB
	Non-Sterilized	2.2ml	Blue	Bulk	DP22VS-9-B
	 Low Retention, Non-Sterilized	2.2ml	Blue	Bulk	DP22VS-9-B-LB
	Pre-Sterilized	2.2ml	Blue	Bulk	DP22VS-9-BS
	 Low Retention, Pre-Sterilized	2.2ml	Blue	Bulk	DP22VS-9-BS-LB
	Non-Sterilized	2.2ml	Red	Bulk	DP22VS-9-R
	 Low Retention, Non-Sterilized	2.2ml	Red	Bulk	DP22VS-9-R-LB
	Pre-Sterilized	2.2ml	Red	Bulk	DP22VS-9-RS
	 Low Retention, Pre-Sterilized	2.2ml	Red	Bulk	DP22VS-9-RS-LB

### Sealing mat fit 96 Square well series Made of virgin Thermoplastic polyurethane



**Packaging Specification:**  
10 mats per bag, 5 bags per case

	Type	Color	Description	Packaging	GEB Cat#
	Common	White	Non-Sterilized, "+" Hole	Bulk	DPMS-9-W+
	Common	White	Pre-Sterilized, "+" Hole	Bulk	DPMS-9-WS+
	Chemically Resistant	White	Non-Sterilized, "+" Hole	Bulk	DPMS-9-IMP-W+
	Chemically Resistant	White	Pre-Sterilized, "+" Hole	Bulk	DPMS-9-IMP-WS+

# Blue GEB, Your Better Choice



## Deep Well Plates 384 Square Well Series



120µl Deep-well plate, square well-V bottom,  
Made of virgin polypropylene



**Packaging Specification:**  
10 plates per pack, 10 packs per case

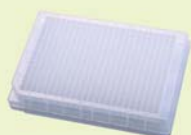

Type	Working Volume	Color	Packaging	GEB Cat#
Non-Sterilized	120 µl	Natural	Bulk	DP12VS-3-N
 Low Retention, Non-Sterilized	120 µl	Natural	Bulk	DP12VS-3-N-LB
Pre-Sterilized	120 µl	Natural	Bulk	DP12VS-3-N-S
 Low Retention, Pre-Sterilized	120 µl	Natural	Bulk	DP12VS-3-N-S-LB



190µl Deep-well plate, square well-V bottom,  
Made of virgin polypropylene



**Packaging Specification:**  
10 plates per pack, 10 packs per case

Type	Working Volume	Color	Packaging	GEB Cat#
Non-Sterilized	190µl	Natural	Bulk	DP19VS-3-N
 Low Retention, Non-Sterilized	190µl	Natural	Bulk	DP19VS-3-N-LB
Pre-Sterilized	190µl	Natural	Bulk	DP19VS-3-N-S
 Low Retention, Pre-Sterilized	190µl	Natural	Bulk	DP19VS-3-N-S-LB

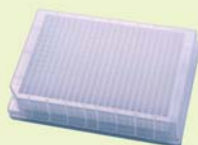

### Compatible Sealing Mats

Sealing mat fit 384 Square well series  
Made of virgin Thermoplastic polyurethane



**Packaging Specification:**  
10 mats per bag, 5 bags per case

Type	Color	Description	Packaging	GEB Cat#
Common	White	Non-Sterilized, "+" Hole	Bulk	DPMS-3-W+
Common	White	Pre-Sterilized, "+" Hole	Bulk	DPMS-3-WS+
Chemically Resistant	White	Non-Sterilized, "+" Hole	Bulk	DPMS-3-IMP-W+
Chemically Resistant	White	Pre-Sterilized, "+" Hole	Bulk	DPMS-3-IMP-WS+



You may also be interested in:

### Lid fit 96/384 Deep-well plate

**Packaging Specification:**  
10 plates per pack, 10 packs per case



Color	Product Description	Packaging	GEB Cat#
Natural	fit 96/384 Deep	Bulk	DPOLID-3-N
Natural	fit 96/384 Deep	Bulk	DPOLID-3-N-S

# Sealing Mats

## Optimum Leakproofness

Drug discovery • Molecular biology • Cell biology



### Exclusive Designed O ring

GEB Seal Mats for Deep Well Plates & Sample Tubes have an exclusive O ring structure, which makes GEB Seal Mat seal a plate more easily with a perfect sealing effect.

#### Features:

- The most complete line of sealing products in the industry, for the most choices.
- EasyPress and MiniSealer offer easier-operating and time-consuming options.
- A wide range of ImpermaMats offer unsurpassed protection for Volatile solvents.
- Films and mats can be used in a wide temperature range, they are suitable for most applications.
- Chemically resistant, pierceable thermoplastic elastomer well caps are excellent for storage to -80°C.
- Silicone pre-slit well caps permit a pipette tip or probe to enter the well without damage to the cap.
- Ethylene-vinyl acetate cap mats effectively seal polystyrene DeepWell™ plates.

# Blue GEB, Your Better Choice

## Silicone Sealing Mats Sealing Mats



### For Sample tubes

#### Sealing Mat fits GEB Sample tubes ST120-C



**Packaging Specification:**  
10 mats per bag, 5 bags per case



Color	Description	Packaging	Fits	GEB Cat#
Natural	Non-Sterilized	Bulk		TTOMAT-9-N

### For PCR microplates

#### 96 well PCR Sealing Mats



**Packaging Specification:**  
10 mats per bag, 5 bags per case

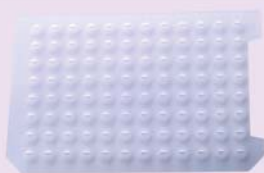

Type	Color	Description	Packaging	GEB Cat#
Common	White	Non-Sterilized, fits 96 PCR Plate, "-" Hole	Bulk	PCOMAT-9-W-
Common	White	Pre-Sterilized, fits 96 PCR Plate, "-" Hole	Bulk	PCOMAT-9-WS-
Chemically Resistant	White	Non-Sterilized, fits 96 PCR Plate, "-" Hole	Bulk	PCOMAT-9-IMP-W-
Chemically Resistant	White	Pre-Sterilized, fits 96 PCR Plate, "-" Hole	Bulk	PCOMAT-9-IMP-WS-

Fit 96 PCR Plates

### Compatible Sealing Mats

#### 384 well PCR Sealing Mats



**Packaging Specification:**  
10 mats per bag, 5 bags per case



Type	Color	Description	Packaging	GEB Cat#
Common	White	Non-Sterilized, "+" Hole	Bulk	DPMR-3-W+
Common	White	Pre-Sterilized, "+" Hole	Bulk	DPMR-3-WS+
Chemically Resistant	White	Non-Sterilized, "+" Hole	Bulk	DPMR-3-IMP-W+
Chemically Resistant	White	Pre-Sterilized, "+" Hole	Bulk	DPMR-3-IMP-WS+

FITS: 384 PCR Plates

### 96-well Sealing Mats for Round Well



**Packaging Specification:**  
10 mats per bag, 5 bags per case



Type	Color	Description	Packaging	GEB Cat#
Common	White	Non-Sterilized, "-" Hole	Bulk	DPMR-9-W-
Common	White	Pre-Sterilized, "-" Hole	Bulk	DPMR-9-WS-
Chemically Resistant	White	Non-Sterilized, "-" Hole	Bulk	DPMR-9-IMP-W-
Chemically Resistant	White	Pre-Sterilized, "-" Hole	Bulk	DPMR-9-IMP-WS-

Fit DP13UR-9I-N

## Silicone Sealing Mats Sealing Mats



### 96-well Sealing Mats for Round Well

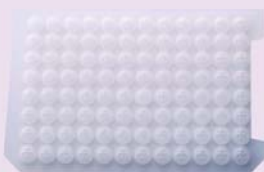

**Packaging Specification:**  
10 mats per bag, 5 bags per case

	Type	Color	Description	Packaging	GEB Cat#
	Common	White	Non-Sterilized, "+" Hole	Bulk	DPMR-9-W+
	Common	White	Pre-Sterilized, "+" Hole	Bulk	DPMR-9-WS+
	Chemically Resistant	White	Non-Sterilized, "+" Hole	Bulk	DPMR-9-IMP-W+
	Chemically Resistant	White	Pre-Sterilized, "+" Hole	Bulk	DPMR-9-IMP-WS+

Fit DP12UR-9-N

### 96-well Sealing Mats for Square Well



**Packaging Specification:**  
10 mats per bag, 5 bags per case

	Type	Color	Description	Packaging	GEB Cat#
	Common	White	Non-Sterilized, "+" Hole	Bulk	DPMS-9-W+
	Common	White	Pre-Sterilized, "+" Hole	Bulk	DPMS-9-WS+
	Chemically Resistant	White	Non-Sterilized, "+" Hole	Bulk	DPMS-9-IMP-W+
	Chemically Resistant	White	Pre-Sterilized, "+" Hole	Bulk	DPMS-9-IMP-WS+

Fit DP12VS-9-N/DP22VS-9-N

### 384-well Reservoirs Sealing Mats for Square Well



**Packaging Specification:**  
10 mats per bag, 5 bags per case

	Type	Color	Description	Packaging	GEB Cat#
	Common	White	Non-Sterilized, "+" Hole	Bulk	DPMS-3-W+
	Common	White	Pre-Sterilized, "+" Hole	Bulk	DPMS-3-WS+
	Chemically Resistant	White	Non-Sterilized, "+" Hole	Bulk	DPMS-3-IMP-W+
	Chemically Resistant	White	Pre-Sterilized, "+" Hole	Bulk	DPMS-3-IMP-WS+

Fit DP19VS-3-N



# Blue GEB, Your Better Choice



## Silicone Sealing Mats Separable Sealing Mats



For 96 Round deep well plate & GEB sample tube

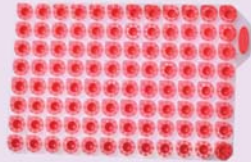
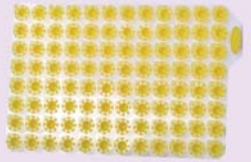

**Packaging Specification:**  
10 mats per bag, 5 bags per case

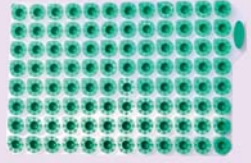
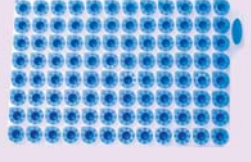
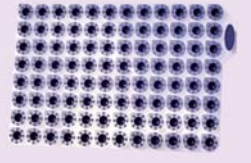
	Color	Packaging	GEB Cat#
	Red	Bulk	CSMATR-9-R
	Yellow	Bulk	CSMATR-9-Y
	Orange	Bulk	CSMATR-9-O
	Green	Bulk	CSMATR-9-G
	Blue	Bulk	CSMATR-9-B
	Violet	Bulk	CSMATR-9-V

# Blue GEB, Your Better Choice

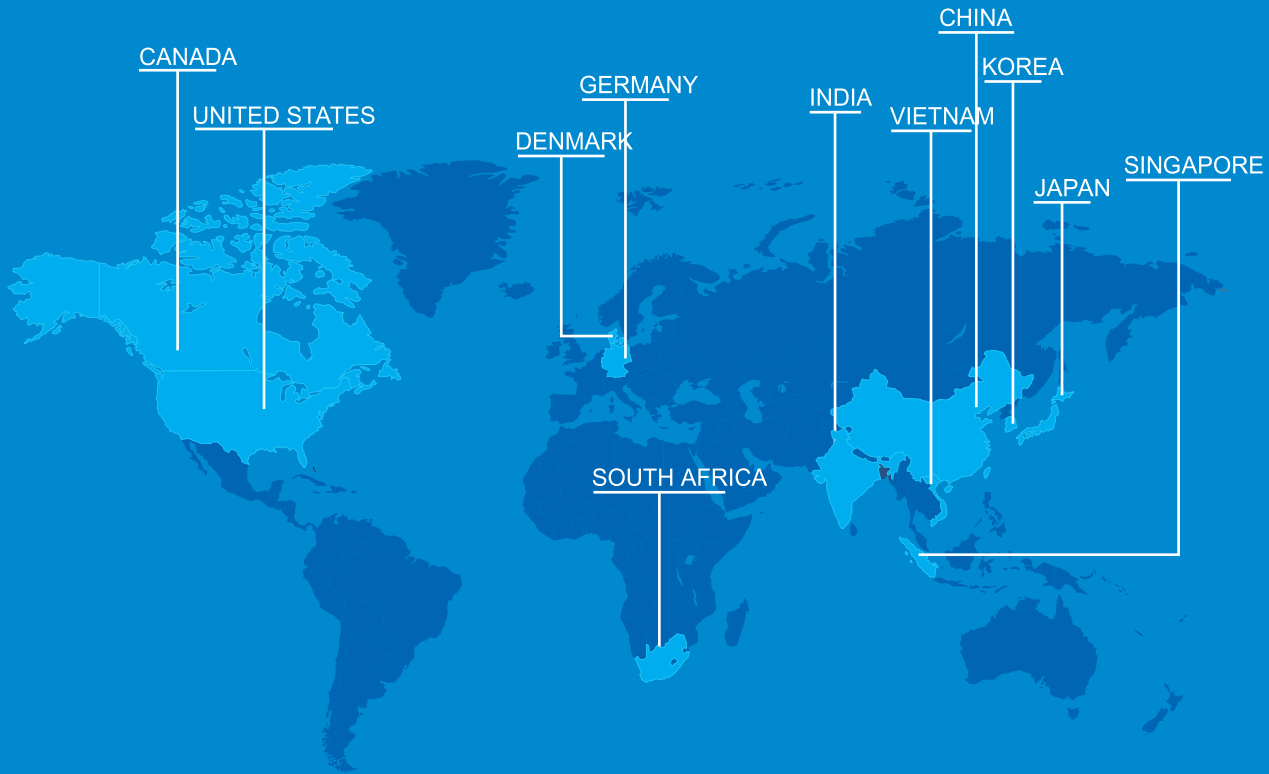

Quality Laboratory Consumables

1721 West Rose Garden, Suite 1, Phoenix, AZ 95027, USA  
TEL: +1-623-236-8804 FAX: +1-623-215-8978  
EMAIL: sales@i-labpro.com WEB: www.ge-bio.com

## Gene Era Biotech, Ltd.

No. 256, South Jianghong Rd., Binjiang District, Hangzhou 310052, P.R.China  
TEL: +86-571-89900629 FAX: +86-571-89900625  
EMAIL: csc@ge-bio.com WEB: www.ge-bio.com

